

A1

MF 190LB

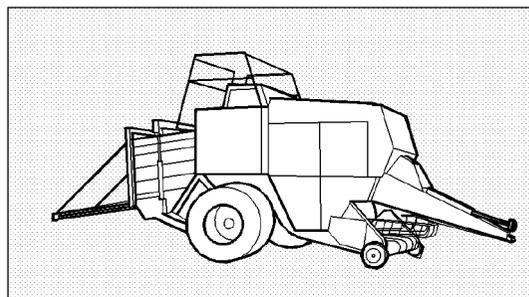

1637308 M8

(1)

04/05

MASSEY FERGUSON



CONTENTS

SOMMAIRE

INHALT

CONTENUTO

SUMARIO

SECTION ONE

SECTION UNE

ABSCHNITTEINS

SEZIONE PRIMA

SECCION PRIMERA

- GENERAL INFORMATION
- SYMBOLS
- GROUP INDEX ALPHA.
- RECOMMENDED STOCKING PARTS
- MARKETING KEY PARTS INDEX
- CHANGES AFTER PREVIOUS PUBLICATION INDEX
- NUMERICAL PART NUMBER INDEX

- INFORMATIONS GENERALES
- SYMBOLES
- GROUPE DE MONTAGE
- PIECES DONT LE STOCKAGE EST RECOMMANDE
- PIECES DE VENTES COURANTES
- CHANGEMENT DEPUIS LA DERNIERE EDITION
- INDEX NUMERIQUE PIECES

- ALLGEMEINE HINWEISE
- SYMBOLE
- GRUPPENVERZEICHNIS
- LAGERVOSCHLAGSTEILE
- SCHWERPUNKTEILE MARKETING
- AENDERUNG GEGENEUBER VORIGER AUSGABE
- NUMMERN - INDEX

- INFORMAZIONI GENERALI
- SIMBOLI
- GRUPPO INDICE
- PEZZI CHE RECCOMANDIANO DI TENERE A MAGAZZINO
- PEZZI ESSENZIALI PER IL MARKETING
- VARIAZIONE RISPETTO ALL ULTIMA EMISSIONE
- INDICE NUMERICO

- INFORMATION GENERAL
- SIMBOLOS
- GROUPOS DE MONTAJE
- RECAMBIO QUE SE RECOMIENDA MANTENER EN STOCK
- RECAMBIO SELECCIONADO POR MARKETING COMO PIEZAS CLAVE
- MOD. DESDE LA ULTIMA EDICION
- INDICE NUMERICO

SECTION TWO

SECTION DEUX

ABSCHNITT ZWEI

SEZIONE SECONDA

SECCION SEGUNDA

- ILLUSTRATIONS WITH REFERENCES
- PART NUMBER REFERENCE LISTS

- ILLUSTRATIONS AVEC REFERENCES
- LISTES DES NUMEROS DE REFERENCE DES PIECES

- ABBILDUNGEN MIT POSITIONS NUMMERN
- TEXTSEITEN MIT TEILNUMMERN

- ILLUSTRAZIONI CON REFERIMENTI
- ELENCO DEI PARTICOLARI RICAMBIO

- DIBUJOS CON REFERENCIAS
- LISTAS CON LOS NUMEROS DE REFERENCIA

GENERAL INFORMATION

A3

I PART NUMBER REFERENCE LIST

(1) EXAMPLE

A	B	C	D	E	F	G	H	J
							K	L
1		161168M4	1		1	DIFFERENTIAL	DIFFERENTIEL DIFFERENZIALE	DIFFERENTIAL DIFFERENCIAL
2		3619014M1	2		1	KIT	JEU IL GRUPPO	REPARATURSATZ JUEGO
3			2	☐→ REF.2	1	CROWNWHEEL	COURONNE CORONA	TELLERRAD CORONA
4			2	☐→ REF.2	1	PINION	PIGNON PIGNONE	ZAHNRAD PINON
5	*	3617401M5	2	→ 1234567	1	BOLT	BOULON BULLONE	SCHRAUBE PERNO
6	*	3617352M3	2	→ 1234567	1	BOLT	BOULON BULLONE	SCHRAUBE PERNO

(2) EXPLANATION

COL. A	ILLUSTRATION REFERENCE NUMBER
COL. B	AN ASTERISK INDICATES A CHANGE SINCE LAST PRINT
COL. C	PART NUMBER (SEE PARAGRAPH 2)
COL. D	ITEM ALSO A COMPONENT OF AN ASSEMBLY. SEE ASSEMBLY ILLUSTRATION NUMBER INDICATED
COL. E	COMMENT (SEE SYMBOLS AND NOTES)
COL. F	QUANTITY REQUIRED (SEE NOTES BELOW)
COL. G.H.J.K.L	DESCRIPTION LANGUAGE FORMAT : ENGLISH, FRENCH, GERMAN, ITALIAN, SPANISH

II PART NUMBER IDENTIFICATION

- 161168M4** = RECOMMENDED STOCKING PARTS AND MARKETING KEY PARTS
- 3619014M1** = RECOMMENDED STOCKING PARTS
- 3617401M5** = MARKETING KEY PARTS INDEX
- 3617352M3** = PART WITHOUT SPECIFIC MARKS

(3) SPECIAL NOTES

THE QUANTITY SHOWN IN COLUMN 'F' IS THE QUANTITY REQUIRED FOR THE PARTICULAR APPLICATION THAT IS ILLUSTRATED. WHERE THESE PARTS ARE COMPONENTS OF AN ASSEMBLY THIS REFERS TO THE QUANTITY IN ONE ASSEMBLY OR SUB-ASSEMBLY. FOR PARTS SUCH AS SHIMS, WASHERS, ETC. AN 'X' IN THE QUANTITY COLUMN MEANS "QUANTITY AS REQUIRED"

THE PARTS BOOK NUMBER, ISSUE NUMBER AND DATE ARE SHOWN IN THE LOWER RIGHT HAND CORNER OF THE ILLUSTRATED PAGE. THE ISSUE NUMBER IS PRINTED IN BRACKETS

RECOMMENDED STOCKING PARTS

THE INDEX OF THESE PARTS INCLUDES A COLUMN QTY REPORTING THE QUANTITY USED FOR EACH PART IN THE RELEVANT FITTING.

SAFETY NOTE

WHEN ORDERING REPLACEMENT PARTS TO WHICH SAFETY DECALS WERE ORIGINALLY ATTACHED THE APPROPRIATE SAFETY DECALS MUST BE ORDERED AND FITTED.

INFORMATIONS GENERALES

A4

I LISTES DES NUMEROS DE REFERENCE DES PIECES

(1) EXEMPLE

A	B	C	D	E	F	G	H	J
							K	L
1	161168M4		1		1	DIFFERENTIAL	DIFFERENTIAL DIFFERENZIALE	DIFFERENTIAL DIFFERENCIAL
2	3619014M1		2		1	KIT	JEU IL GRUPPO	REPARATURSATZ JUEGO
3			2	REF.2	1	CROWNWHEEL	COURONNE CORONA	TELLERRAD CORONA
4			2	REF.2	1	PINION	PIGNON PIGNONE	ZAHNRAD PINON
5	* 3617401M5		2	→ 1234567	1	BOLT	BOULON BULLONE	SCHRAUBE PERNO
6	* 3617352M3		2	→ 1234567	1	BOLT	BOULON BULLONE	SCHRAUBE PERNO

(2) EXPLICATIONS

COL. A	NUMERO DE REFERENCE DE L'ILLUSTRATION
COL. B	UN ASTERISQUE INDIQUE UN CHANGEMENT DEPUIS LA DERNIERE EDITION
COL. C	NUMERO DE PIECE (VOIR PARAGRAPHE 2)
COL. D	PIECE COMPRISE DANS L'ENSEMBLE DONT LE NUMERO DE REFERENCE DE L'ILLUSTRATION EST INDIQUE
COL. E	REMARQUE (VOIR SYMBOLES ET NOTES)
COL. F	QUANTITE (VOIR NOTE CI-DESSOUS)
COL. G.H.J.K.L	DESIGNATION ORDRE DES LANGUES ANGLAIS, FRANCAIS, ALLEMAND, ITALIEN, ESPAGNOL

II IDENTIFICATION DES NUMEROS DE PIECES

- 161168M4** = PIECES DONT LE STOCKAGE EST RECOMMANDE ET PIECES DE VENTES COURANTES
- 3619014M1** = PIECES DONT LE STOCKAGE EST RECOMMANDE
- 3617401M5** = PIECES DE VENTES COURANTES
- 3617352M3** = PIECES SANS SIGNIFICATION PARTICULIERE

(3) NOTES SPECIALES

LA QUANTITE INDIQUEE DANS LA COLONNE 'F' EST CELLE APPLICABLE A L'ENSEMBLE ILLUSTRÉ SUR LA PAGE ADJACENTE, LE NOMBRE INDIQUE DONC LA QUANTITE DANS L'ENSEMBLE OU SOUS-ENSEMBLE ET NON POUR LA MACHINE COMPLETE.

POUR DES PIECES TELLES QUE CALES D'ÉPAISSEUR, RONDELLES, ETC. UN "X" DANS LA COLONNE QUANTITE SIGNIFIE "SUIVANT BESOIN".

LE NUMERO DU CATALOGUE, LE NUMERO D'ÉMISSION ET LA DATE SONT INDICÉS DANS LE COIN INFÉRIEUR DROIT DE LA PAGE ILLUSTRÉE. LE NUMERO D'ÉMISSION EST IMPRIMÉ ENTRE PARENTHESES.

PIECES DONT LE STOCKAGE EST RECOMMANDE

L'INDEX DE CES PIECES INCLUS UNE COLONNE QTY QUI LISTE LA QUANTITE UTILISÉE DE CHAQUE PIECE POUR LE MONTAGE.

NOTE DE SECURITE

LORS DU REMPLACEMENT DE PIECES MUNIES A L'ORIGINE D'UNE DECALCOMANIE DE SECURITE. LA DECALCOMANIE CORRESPONDANTE DOIT AUSSI ETRE COMMANDEE ET MONTEE.

ALLGEMEINE HINWEISE

A5

I TEXTSEITEN MIT TEILNUMMERN

(1) BEISPIEL

A	B	C	D	E	F	G	H	J
							K	L
1		1611168M4	1		1	DIFFERENTIAL	DIFFERENTIEL DIFFERENZIALE	DIFFERENTIAL DIFFERENCIAL
2		3619014M1	2		1	KIT	JEU IL GRUPPO	REPARATURSATZ JUEGO
3			2	☐ REF.2	1	CROWNWHEEL	COURONNE CORONA	TELLERRAD CORONA
4			2	☐ REF.2	1	PINION	PIGNON PIGNONE	ZAHNRAD PINON
5	*	3617401M5	2	→ 1234567	1	BOLT	BOULON BULLONE	SCHRAUBE PERNO
6	*	3617352M3	2	→ 1234567	1	BOLT	BOULON BULLONE	SCHRAUBE PERNO

(2) ERLAEUTERUNG

COL. A	POSITIONSNUMMER DER ABBILDUNG
COL. B	EIN STERN BEDEUTET AENDERUNG GEGENEUBER VORIGER AUSGABE
COL. C	TEILNUMMER (SEHE ABSATZ 2)
COL. D	EINZELTEIL VON KOMPLETTEIL, DESSEN POSITIONSNUMMER HIER ANGEGEBEN IST
COL. E	BEMERKUNGEN (SIEHE SYMBOLE UND HINWEISE)
COL. F	ANZAHL (SIEHE UNTENSTEHENDE ANMERKUNG)
COL. G.H.J.K.L	SPRACHEN - BESCHREIBUNG ENGLICH, FRANZOESISCH, DEUTSCH, ITALIENSCH UND SPANISCH

II FESTSTELLEN DER TEILNUMMER

1611168M4 = LAGERVORSCHLAGSTEILE
UND SCHWERPUNKTEILE MARKETING
3619014M1 = LAGERVORSCHLASTEILE
3617401M5 = SCHWERPUNKTEILE MARKETING
3617352M3 = TEIL OHNE SPEZIFIKATIONS KENNZEICHNUNG

(3) ANMERKUNGEN

DIE IN SPALTE 'F' AUFGEFUEHRTE ANZAHL IST DIE AN DER STELLE BENOETIGTE ANZAHL. FALLS ES SICH UMEIN EINZELTEIL EINES KOMPLETTEILS HANDELT, IST DIE ANZAHL PRO KOMPLETTEIL ODER ZUSAMMENBAUGEMEINT.
FUER TEILE WIE EINSTELLBLECHE, SCHEIBEN USW BEDEUTET EIN 'X' IN DER ANZAHLSPALTE "ANZAHL NACH BEDARF".
DIE TEILNUMMER DER ERSATZTEILLISTE, AUSGABENUMMER UND DATUM SIND IN DER RECHTEN UNTEREN ECKE DER BILDSEITE AUFGEFUEHRT. DIE AUSGABENUMMER STEHT IN KLAMMERN.

ZUR LAGERHALTUNG EMPFOHLENE ERSATZTEILE

DER ERSATZTEIL INDEX ENTHAELT EINE SPALTE "MENGE", WELCHE DIE ANZAHL DER ZUM ZUSAMMENBAU ERFORDERLICHEN ANGIBT.

WECHTIGER HINWEIS

WENN ERSETZTE TEILE BESTELT WERDEN, BEI DENEN SICHERHEITSAZIEHBILDER WAREN, MUESSEN DIE ENTSPRECHENDEN SICHERHEITSAZIEHBILDER BESTELT UND ANGEBRACHT WERDEN.

INFORMAZIONI GENERALI

A6

I ELENCO DEL PARTICOLARI RICAMBIO

(1) ESEMPION

A	B	C	D	E	F	G	H	J
							K	L
1		161168M4	1		1	DIFFERENTIAL	DIFFERENTIEL DIFFERENZIALE	DIFFERENTIAL DIFFERENCIAL
2		3619014M1	2		1	KIT	JEU IL GRUPPO	REPARATURSATZ JUEGO
3			2  REF.2	1		CROWNWHEEL	COURONNE CORONA	TELLERRAD CORONA
4			2  REF.2	1		PINION	PIGNON PIGNONE	ZAHNRAD PINON
5	*	3617401M5	2  1234567	1		BOLT	BOULON BULLONE	SCHRAUBE PERNO
6	*	3617352M3	2  1234567	1		BOLT	BOULON BULLONE	SCHRAUBE PERNO

(2) SPIEGAZIONE

COL. A	NUMERO DI RIFERIMENTO DELL ILLUSTRAZIONE
COL. B	UN ASTERISCO INDICA UNA VARIAZIONE RISPETO ALL ULTIMA EMISSIONE
COL. C	NUMERO DEL RECAMBIO (VEDER PARAGRAFO 2)
COL. D	IL PARTICOLARE E ANCHE COMPONENTE DI UN GRUPPO IL CUI NUMERO DI ILLUSTRAZIONE E INDICATO
COL. E	COMENTO (VEDER SIMBOLI E NOTE)
COL. F	QUANTITA RECHIESTA (VEDERE NOTA A SEQUITO)
COL. G.H.J.K.L	DESCRIZIONE - SEQUENZA LIGNUA : INGLESE, FRANCESE, TEDESCO, ITALIANO E SPAGNOLO

II CODICE IDENTIFICAZIONE DEL PARTICOLARE

161168M4 = PEZZI CHE RECOMANDIANO DI TENERE A MAGAZZINO
E PEZZI ESSENZIALI PER IL MARKETING

3619014M1 = PEZZI CHE RECOMANDIANO DI TENERE A MAGAZZINO

3617401M5 = PEZZI ESSENZIALI PER IL MARKETING

3617352M3 = SENZA CODICE IDENTIFICAZIONE DEL PARTICOLARE

(3) NOTE AGGIUNTIVE

LA QUANTITA INDICATA NELLA COLONNA 'F' CORRISPONDE ALLA QUANTITA RICHIESTA PER LA PARTICOLARE APPLICAZIONE ILLUSTRATA. QUALORA LA PARTE SIA COMPONENTE DI UN GRUPPO, LA QUANTITA INDICATA SI REFERISCE ALLA QUANTITA CONTENUTA NEL GRUPPO.

PER PARTICOLARI COME SPESSORI, RONDELLE ETC. UNA 'X' NELLA COLONNA DELLA QUANTITA STA A INDICARE "QUANTITA A RICHIESTA"

IL NUMERO DI RIFERIMENTO DEL CATALOGO, IL NUMERO DI EDIZIONE E LA DATA SONO RIPORTATI IN BASSO A DESTRA NELLA PAGINA ILLUSTRATIVA.

PEZZI CHE RECCOMANDIANO DI TENERE A

L'INDICE DELA LISTA RICAMBI INCLUDE UNA COLONNA QTY CHE INDICA LA QUANTITA PER OGNI CODICE RICAMBI NECESSARIA PER IL MONTAGIO.

NOTA PER LA SICUREZZA

QUANDO VIENE ORDINATO UN PEZZO AL QUALE ERANO
ORIGINARIAMENTE APPLICATE LE DECALCOMANIE PER LA SICUREZZA
ANCHE QUESTE ULTIME DEVONO ESSERE ORDINATE E APPLICATE AL
PEZZO PRIMA DELLA CONSEGNA AL CLIENTE.

INFORMACION GENERAL

A7

I LISTAS CON LOS NUMEROS DE REFERENCIA DE LAS PIEZAS

(1) EJEMPLO

A	B	C	D	E	F	G	H	J
							K	L
1		161168M4	1		1	DIFFERENTIAL	DIFFERENTIEL DIFFERENZIALE	DIFFERENTIAL DIFFERENZIAL
2		3619014M1	2		1	KIT	JEU IL GRUPPO	REPARATURSATZ JUEGO
3			2	REF.2	1	CROWNWHEEL	COURONNE CORONA	TELLERRAD CORONA
4			2	REF.2	1	PINION	PIGNON PIGNONE	ZAHNRAD PINON
5	*	3617401M5	2	→ 1234567	1	BOLT	BOULON BULLONE	SCHRAUBE PERNO
6	*	3617352M3	2	→ 1234567	1	BOLT	BOULON BULLONE	SCHRAUBE PERNO

(2) EXPLICACION

COL. A	NUMERO DE REFERENCIA DEL DIBUJO
COL. B	UN ASTERISCO INDICA UNA MODIFICACION DESDE LA ULTIMA EDICION
COL. C	NUMERO DE PIEZA (VER PARAGRAFO 2)
COL. D	PIEZA INCLUIDA EN EL CONJUNTO CUYO NUMERO DE REFERENCIA DE DIBUJO SE INDICA COMENTARIO (VEANSE LOS SIMBOLOS Y LAS NOTAS)
COL. E	CANTIDAD NECESARIA (VER NOTA A CONTINUACION)
COL. F	CANTIDAD NECESARIA (VER NOTA A CONTINUACION)
COL. G.H.J.K.L	DESCRIPCION - FORMATO DE IDIOMA - INGLES, FRANCES, ALEMAN, ITALIANO Y ESPANOL

II IDENTIFICATION DE NUMERO DE REFERENCIA

161168M4 = RECAMBIO QUE SE RECOMIENDA MANTENER EN STOCK Y RECAMBIO SELECCIONADO POR MARKETING COMO PIEZAS CLAVE

3619014M1 = RECAMBIO QUE SE RECOMIENDA MANTENER EN STOCK

3617401M5 = RECAMBIO SELECCIONADO POR MARKETING COMO PIEZAS CLAVE

3617352M3 = RECAMBIO SIN MARCAS ESPECIFICAS

(3) NOTAS ESPECIALES

LA CANTIDAD INDICADA EN LA COLUMNA 'F' ES LA CANTIDAD NECESARIA PARA EL CONJUNTO DISENADO EN LA PAGINA CONTIGUA, EL NUMERO POR LO TANTO INDICA LA CANTIDAD CORRESPONDIENTE AL CONJUNTO O SUBCONJUNTO Y NO A LA MAQUINA COMPLETA.

PARA DETERMINADAS PIEZAS COMO ESPACIADORES, ARANDELAS, ETC. UNA 'X' EN LA COLUMNA DE CANTIDADES INDICA "SEGUN NECESIDADES".

LA REFERENCIA DEL CATALOGO NUMERO Y FECHA DE EDICION ESTAN IMPRESAS EN EL ANGULO DERECHO INFERIOR DE LA PAGINA ILLUSTRADA EL NUMERO DE EDICION ESTA INDICADO ENTRE PARENTESIS.

RECAMBIO QUE SE RECOMIENDA MANTENER EN STOCK

L'INDEX NUMERICO DE ESTAS PIEZAS INCLUSO UNA COLUMNA QTY QUE LISTA LA CANTIDAD UTILISADA DE CADA PIEZA POR MEL MONTAJE.

AVISO DE SEGURIDAD

CUANDO SE PIDEN PIEZAS DE REPUESTO QUE ORIGINALMENTE LLEVABAN CALCOMANIAS DE SEGURIDAD HAY QUE PEDIR Y COLOCAR TAMBIEN LAS CALCOMANIAS APROPIADAS.

**SYMBOLS / SYMBOLES / SYMBOLE /
SIMBOLI / SIMBOLOS**

A8

	FOUR WHEEL DRIVE	4 ROUES MOTRICES 4 RUEDAS MOTRIZ	4 RAD ANTRIEB 4 RUEDAS MOTRIZ
	TWO WHEEL DRIVE	2 ROUES MOTRICES 2 RUEDAS MOTRIZ	2 RAD ANTRIEB 2 RUEDAS MOTRIZ
	FOR GERMANY ONLY OR ANY TEXT IN GERMAN ONLY	POUR ALLEMAGNE SEULEMENT OU EN ALLEMAND PARA ALEMANIA SOLAMENTE O EN ALEMAN SOLAMENTE	NUR FUER DEUTSCHLAND ODER TEXT NUR IN DEUTSCH PARA ALEMANIA SOLAMENTE O EN ALEMAN SOLAMENTE
	FOR FRANCE ONLY OR ANY TEXT IN FRENCH ONLY	POUR FRANCE SEULEMENT OU EN FRANÇAIS PARA FRANCIA SOLAMENTE O EN FRANCÉS SOLAMENTE	NUR FUER FRANKREICH ODER TEXT NUR IN FRANZÖSISCH PARA FRANCIA SOLAMENTE O EN FRANCÉS SOLAMENTE
	FOR ITALY ONLY OR ANY TEXT IN ITALIAN ONLY	POUR ITALIE SEULEMENT OU EN ITALIEN PARA ITALIA SOLAMENTE O EN ITALIANO SOLAMENTE	NUR FUER ITALIEN ODER TEXT NUR IN ITALIENSCH PARA ITALIA SOLAMENTE O EN ITALIANO SOLAMENTE
	FOR UK ONLY OR ANY TEXT IN ENGLISH ONLY	POUR ROYAUME UNI SEULEMENT OU EN ANGLAIS PARA INGLATERRA SOLAMENTE O EN INGLÉS SOLAMENTE	NUR FUER ENGLAND ODER TEXT NUR IN ENGLISCH PARA INGLATERRA SOLAMENTE O EN INGLÉS SOLAMENTE
	FOR AMERICAS REGION	POUR AMERIQUES PARA REGION DE LAS AMERICAS SOLAMENTE	FUER AMERICA PARA REGION DE LAS AMERICAS SOLAMENTE
	FOR ASIA/AFRICA/AUSTRALASIA REGION	POUR ASIE/AFRIQUE/AUSTRALASIE PARA ASIA/AFRICA/AUSTRALASIA SOLAMENTE	FUER ASIEN/AFRIKA/AUSTRALIEN PARA ASIA/AFRICA/AUSTRALASIA SOLAMENTE
	FOR EXPORT EUROPE	POUR EXPORT EUROPE PARA EXPORTACION EUROPA	FUER EUROPA PARA EXPORTACION EUROPA
	FOR UNITED STATES OF AMERICA	POUR ETATS UNIS D'AMERIQUE PARA EE UU DE AMERICA	FUER USA PARA EE UU DE AMERICA
	FOR AUSTRALIA	POUR AUSTRALIE PARA AUSTRALIA	FUER AUSTRALIEN PARA AUSTRALIA
	FOR SWEDEN	POUR SUEDE PARA SUECA	FUER SCHWEDEN PARA SUECA
	FOR NORWAY	POUR NORVEGE PARA NORVEGA	FUER NORWEGEN PARA NORVEGA
	FOR SOUTH AFRICA	POUR AFRIQUE DU SUD PARA AFRICA DEL SUR	FUER SÜD-AFRIKA PARA AFRICA DEL SUR
	REPLACE AND REPAIR - OLD IS NOT INTERCHANGEABLE WITH NEW	REPLACE ET RECHANGER - NON INTERCHANGEABLE SOSTITUIRE E RIPARARE/NUOVO-VECCHIO NON INTERC.	FUER ERSATZ - ALTE VERSION NICHT AUSTAUS. MIT NEUER VERSION REEMPLAZAR Y REPARAR/LA ANTERIOR NO ES INTERCAM. CON LA NUEVA
	REPLACE AND REPAIR - OLD AND NEW INTERCHANGEABLE	REPLACE ET RECHANGER - INTERCHANGEABLE SOSTITUIRE E RIPARARE/NUOVO-VECCHIO SONO INTERC.	FUER ERSATZ - ALTE VERSION AUSTAUS. MIT NEUER VERSION REEMPLAZAR Y REPARAR/ANTERIOR Y NUEVAS SON INTERCAMB.

SYMBOLS / SYMBOLES / SIMBOLI / SIMBOLOS

A9

	RIGHT HAND	DROITE DESTRA	RECHTS DERECHA
	LEFT HAND	GAUCHE SINISTRA	LINKS IZQUIERDA
	WIDTH	LARGEUR LARGHEZZA	BREITE ANCHURA
	LENGTH	LONGUEUR LUNGHEZZA	LANGE LONGITUD
	THICKNESS	EPAISSEUR SPESSEZZA	STAERKE ESPESOR
	DIAMETER	DIAMETRE DIAMETRO	DURCHMESSER DIAMETRO
	NUMBER OF TEETH/SPLINES	NOMBRE DE DENTS/CANNELURES NUMERO DE DENTES/CALETTATURAS	ANZAHL DER ZAEHNE/YERZAHNUNG NUMERO DE DIENTES/RANURAS
	TOP	HAUT PARTE SUPERIORE	OBEN PARTE SUPERIOR
	BOTTOM	BAS PARTE INFERIORE	UNTEN PARTE INFERIOR
	FROM SERIAL OR ENGINE NUMBER	A PARTIR DU NUMERO DE SERIE DU NUMERO DE MOTEUR DESDE EL NUMERO	AB SERIEN-ODER MOTOR NUMMER DESDE EL NUMERO
	UP TO SERIAL OR ENGINE NUMBER	JUSQU'AU NUMERO DE SERIE OU NUMERO DE MOTEUR HASTA EL NUMERO	DROITE HASTA EL NUMERO
	REPAIRS AND REPLACES	REPLACE ET RECHANGE SURROGARE Y RICAMBIO	ERSETZT REEMPLAZA Y SUSTIUYE
	SEE PAGE - REFERENCE NUMBER	VOIR PAGE - NUMERO DE REFERENCE VER PAGINA - NUMERO DE REFERENCIA	SIEHE SEITE - POSITIONSNUMMER VER PAGINA NUMERO DE REFERENCIA
	ALTERNATIVE	ALTERNATIVE ALTERNATIVO	WAHLWEISE ALTERNATIVO
	NOT SERVICED, ORDER	PAS FOURNIES, COMMANDER NO SUMINISTRADAS, PEDIR	NICHT LIEFERTEILE, BESTELLE NO SUMINISTRADAS, PEDIR
	WITHOUT OR NOT FOR. EXAMPLE: NOT FOR ENGLAND	SANS OU PAS POUR EXEMPLE : PAS POUR ANGLETERRE SON O NO PARA. EJEMPLO : NO PARA INGHILTERRA	OHNE ODER NICHT FUER. BEISPEL : FUER DEUTSCHLAND SON O NO PARA. EJEMPLO : NO PARA INGLETERRA

A10

RESERVED

		PAGE			PAGE
BA01	 <p>TRANSMISSION TRANSMISSION GETRIEBE TRANSMISSIONE TRANSMISSION</p>	10	BA11	 <p>HYDRAULICS HYDRAULIQUE HYDRAULISCHE IDRAULICI HIDRAULICOS</p>	70
BA02	 <p>PICK-UP PICK-UP AUFSAMMELTROMMEL RACCOGLITORE RECOGEDOR</p>	20	BA12	 <p>ACCESSORIES AND DECALS ACCESSOIRES ET DECALCOMANIES ZUBEHOER UND AUFKLEBER ACCESSORIES E DECALCOMANIES ACCESORIOS Y CALLOMANIES</p>	80
BA10	 <p>ELECTRICAL ELECTRICITE ELEKTRIZITAT ELETTRICITA ELECTRICIDAD</p>	30			
BA04	 <p>CHARGE AND PLUNGER ALIMENTATION ZUBRINGER ALIMENTATORE ALIMENTACIONE</p>	40			
BA06	 <p>KNOTTER NOUEUR BINDER LEGATORE ANUDADORA</p>	50			
BA07	 <p>MAINFRAME WHEELS AND SHIELD ASSEMBLIES BATI ROUES ET GARANTS RAHMEN RAEDER UND SCHUTZBLECHE TELAIO RUOTE DIFESA BASTIDOR RUEDAS PROTECCIONE</p>	60			

--	--	--

RESERVED

ALPHABETICAL INDEX**C1**

	PAGE		PAGE
Accessories And Decals			
Accessories And Decals	80 – 30	Lubrication	50 – 15
Bale Chute	80 – 50	Needle	50 – 5
Connector Assembly Kit	80 – 60	Star Wheel	50 – 95
Decals	80 – 5	Mainframe Wheels And Shield Assemblies	
Fieldstar	80 – 95	Bale Tensioner	60 – 5
Hydraulic	80 – 80	Brake System	60 – 135
Literature	80 – 100	Ladder Rails	60 – 85
Lubrication	80 – 85	Shields	60 – 15
Transmission	80 – 65	Twine Box	60 – 65
		Wheel	60 – 155
Charge And Plunger		Pick-Up	
Charge And Plunger	40 – 45	Chain Drive	20 – 15
Finger	40 – 25	Clutch	20 – 30
Hay Check	40 – 30	Pick-Up	20 – 5
Plunger	40 – 60	Shields	20 – 45
Transmission	40 – 5	Wheel	20 – 60
Electrical		Transmission	
Electrical	30 – 5	Chain Drive	10 – 85
Electrical Plug	30 – 100	Clutch	10 – 40
Lighting Equipment	30 – 40	Gearbox	10 – 50
Hydraulics		Hitch Safety Chain – Jack	10 – 5
Blower	70 – 75	Transmission	10 – 15
Blower & Oil Tank	70 – 70		
Hydraulic	70 – 5		
Hydraulic Cylinder	70 – 35		
Hydraulic Flow Control Valve	70 – 20		
Hydraulic Motor	70 – 80		
Hydraulic Pump	70 – 65		
Knotter	70 – 55		
Knotter			
Frame	50 – 20		
Hay Check	50 – 40		
Knotter	50 – 30		
Knotter Control			
Cam Assembly	50 – 25		
Frame	50 – 50		

INDEX ALPHABETIQUE**C2**

	PAGE		PAGE
Accessoires Et Decalcomanies		Noueur	
Accessoires Et Decalcomanies	80 – 30	Aiguille	50 – 5
Decalcomanies	80 – 5	Chassis	50 – 20
Fieldstar	80 – 95	Commande Des Noureux	
Hydraulique	80 – 80	Bati	50 – 50
Jeu D'Accouplement	80 – 60	Ensemble Came	50 – 25
Litterature	80 – 100	Declencheur	50 – 95
Lubrification	80 – 85	Lubrification	50 – 15
Rampe De Dechargement	80 – 50	Noueur	50 – 30
Transmission	80 – 65	Reteneur Escamotable	50 – 40
Alimentation		Pick-Up	
Alimentation	40 – 45	Embrayage	20 – 30
Ameneurs	40 – 25	Garants	20 – 45
Piston	40 – 60	Pick-Up	20 – 5
Reteneur Escamotable	40 – 30	Roues	20 – 60
Transmission	40 – 5	Transmission Par Chaîne	20 – 15
Bati Roues Et Garants		Transmission	
Boite A Ficelle	60 – 65	Boite De Vitesses	10 – 50
Chambre De Compression	60 – 5	Chaîne De Securite – Cric	10 – 5
Echelle	60 – 85	Embrayage	10 – 40
Garants	60 – 15	Transmission	10 – 15
Roues	60 – 155	Transmission Par Chaîne	10 – 85
Systeme De Freinage	60 – 135		
Electricite			
Eclairage	30 – 40		
Electricite	30 – 5		
Prise Electrique	30 – 100		
Hydraulique			
Commande Hydraulique			
Valve	70 – 20		
Hydraulique	70 – 5		
Moteur Hydraulique	70 – 80		
Noueur	70 – 55		
Pompe Hydraulique	70 – 65		
Soufflerie	70 – 75		
Soufflerie & Reservoir D'Huile	70 – 70		
Verin Hydraulique	70 – 35		

ALPHABETISCHER INDEX**C3**

	PAGE		PAGE
Aufsammeltrommel			
Aufsammeltrommel	20 – 5	Aufstieg	60 – 85
Kettenantrieb	20 – 15	Brems System	60 – 135
Kupplung	20 – 30	Garnbehälter	60 – 65
Rader	20 – 60	Kanalverstellung	60 – 5
Schutzbleche	20 – 45	Rader	60 – 155
		Schutzbleche	60 – 15
Binder		Zubehoer Und Aufkleber	
Binder	50 – 30	Aufkleber	80 – 5
Binderantrieb		Ballenrutsche	80 – 50
Nocken Kpl	50 – 25	Fieldstar	80 – 95
Rahmen	50 – 50	Getriebe	80 – 65
Nadeln	50 – 5	Hydraulik	80 – 80
Pressgut–Rueckhalter	50 – 40	Literatur	80 – 100
Rahmen	50 – 20	Satz Kupplungsstueck	80 – 60
Schmierer	50 – 15	Schmierer	80 – 85
Strohrad	50 – 95	Zubehoer Und Aufkleber	80 – 30
Elektrizitat		Zubringer	
Beleuchtung	30 – 40	Getriebe	40 – 5
Elektrischer Stecker	30 – 100	Kolben	40 – 60
Elektrizitat	30 – 5	Pressgut–Rueckhalter	40 – 30
Getriebe		Zubringer	40 – 25
Getriebe	10 – 15		
Kettenantrieb	10 – 85		
Kupplung	10 – 40		
Sicherheitskette – Abstellstuetze	10 – 5		
Hydraulische			
Binder	70 – 55		
Geblyse	70 – 75		
Geblyse & Oeltank	70 – 70		
Hydraulik	70 – 5		
Hydraulikmotor	70 – 80		
Hydraulikpumpe	70 – 65		
Hydraulikzylinder	70 – 35		
Hydraulischer Antrieb			
Ventil	70 – 20		
Rahmen Raeder Und Schutzbleche			

INDICE ALFABETICO**C4**

	PAGE		PAGE
Accessories E Decalcomanies			
Accessories E Decalcomanies	80 - 30	Legatore	50 - 30
Decalcomanie	80 - 5	Lubrificazione	50 - 15
Fieldstar	80 - 95	Telaio	50 - 20
Idraulica	80 - 80		
Kit Raccordi	80 - 60	Raccoglitore	
Letteratura	80 - 100	Difese	20 - 45
Lubrificazione	80 - 85	Frizione	20 - 30
Scivolo Per Balle	80 - 50	Raccoglitore	20 - 5
Trasmissione	80 - 65	Ruota	20 - 60
		Trasmissione A Catena	20 - 15
Alimentatore			
Alimentatore	40 - 45	Telaio Ruote Difesa	
Controllo Fieno	40 - 30	Difese	60 - 15
Infaldatore	40 - 25	Guida Scala	60 - 85
Pistone	40 - 60	Ruota	60 - 155
Trasmissione	40 - 5	Scatola Portafilo	60 - 65
		Sistea Di Frenata	60 - 135
		Tenditore Balle	60 - 5
Elettricita			
Elettricita	30 - 5	Trasmissione	
Equipaggiamento Illuminazione	30 - 40	Cambio Di Velocita	10 - 50
Presaelettricita	30 - 100	Catena Sicurezza - Martinetto	10 - 5
		Frizione	10 - 40
Idraulici		Trasmissione	10 - 15
Cilindros Idraulico	70 - 35	Trasmissione A Catena	10 - 85
Idraulica	70 - 5		
Legatore	70 - 55		
Mando Hidraulico			
Valvola	70 - 20		
Motor Hydraulic	70 - 80		
Pomp Idraulica	70 - 65		
Soffiatore	70 - 75		
Soffiatore & Serbatoio Olio	70 - 70		
Legatore			
Ago	50 - 5		
Braccio Di Scatto	50 - 95		
Commando Legatore			
Cammacomplet	50 - 25		
Telaio	50 - 50		
Controllo Fieno	50 - 40		

INDICE ALFABETICO**C5**

	PAGE		PAGE
Accesorios Y Callomanies		Hidraulicos	
Accesorios Y Callomanies	80 - 30	Anudadora	70 - 55
Callomanies	80 - 5	Bomba Hidraulica	70 - 65
Engrase	80 - 85	Cilindro Hidraulico	70 - 35
Fieldstar	80 - 95	Comando Idraulico	
Hidraulico	80 - 80	Valvula	70 - 20
Juego De Conjunto De Conectador	80 - 60	Ensiladora	70 - 75
Literatura	80 - 100	Ensiladora & Deposito De Aceite	70 - 70
Tobogan De Descarga	80 - 50	Hidraulico	70 - 5
Transmission	80 - 65	Motore Idraulico	70 - 80
Alimentacione		Recogedor	
Alimentacione	40 - 45	Accionamiento Cadena	20 - 15
Control	40 - 30	Embraque	20 - 30
Embocador	40 - 25	Proteccionee	20 - 45
Stantuffo	40 - 60	Recogedor	20 - 5
Transmission	40 - 5	Rueda	20 - 60
Anudadora		Transmission	
Aguja	50 - 5	Accionamiento Cadena	10 - 85
Anudadora	50 - 30	Cadena Seguridad - Gato Armado	10 - 5
Bastidor	50 - 20	Caja De Cambios	10 - 50
Control	50 - 40	Embraque	10 - 40
Engrase	50 - 15	Transmission	10 - 15
Mando Del Anudadora			
Bastidor	50 - 50		
Levacjt	50 - 25		
Rueda Medicion	50 - 95		
Bastidor Ruedas Proteccionee			
Caja De La Bobina	60 - 65		
Guia Escala	60 - 85		
Proteccionee	60 - 15		
Rueda	60 - 155		
Sistema De Frenado	60 - 135		
Tensor Paca	60 - 5		
Electricidad			
Electricidad	30 - 5		
Equipo Alumbrado	30 - 40		
Tomacorriente	30 - 100		

--	--	--

RESERVED

RECOMMENDED STOCKING PARTS

D1

Qty PAGE			Qty PAGE			Qty PAGE			Qty PAGE		
ACTUATOR	700709996	1 30-25	BEARING	7713829	2 40-65	BOLT	70922786	2 10-15	BULB S/L 21/5W	908543M1	1 30-45
ACTUATOR	700710211	2 30-10	BEARING	7713837	1 40-25			2 10-100			1 30-55
		1 30-20			1 40-35			3 20-15			1 30-65
		2 30-25	BEARING	8050478	1 50-25			55 20-15	BUMPER	827568	1 40-55
		1 30-95	BEARING	8050866	2 50-20			40 20-20	BUSH	52761	8 60-10
BALL BEARING	700722661	12 50-5	BEARING	Y710392	10 20-15			6 20-25	BUSH	6523500	7 50-25
		12 50-10	BEARING ASSY	700706124	4 40-65			6 40-5			3 50-40
		1 50-20	BEARING CONE	700706039	2 10-45			8 40-10	BUSH	6523799	1 30-20
		6 50-20	BEARING CONE	70341230	4 20-60			8 40-15			10 50-20
		1 50-80	BEARING CONE	70927347	2 10-90			16 40-45	BUSH	6565030	1 10-105
		1 50-120	BEARING CUP	700706038	2 10-45			4 40-55	BUSH	700122681P	6 50-50
		1 50-125	BEARING CUP	70927348	2 10-90			16 40-65			6 50-55
BALL BEARING	70575883	4 20-35	BEARING CUP	832190M1	4 20-60			2 40-70	BUSH	700124038	12 40-5
		4 20-40	BEARING FLANGE	700108622P	10 20-15			6 50-50			12 40-10
BAR	700113189	7 40-65	BEARING FLANGE	700109753P	1 10-95			6 50-55			12 40-15
BASE	700102136	1 50-35			1 10-100			4 50-65	BUSH	70936273	1 60-10
BEARING	1109055	2 40-5			4 40-10			4 50-70	BUSH	712810	1 40-25
		6 40-10			1 40-15			5 50-105			1 40-35
		2 40-15	BEARING FLANGE	700715941	1 50-80			7 50-110			2 50-5
BEARING	1124697	1 10-40	BEARING FLANGE	700716611	1 40-15			1 60-20			2 50-10
BEARING	50393	2 40-5	BEARING FLANGE	71122510	2 20-55			1 60-25	BUSH	7849110	6 50-20
		2 40-10	BEARING FLANGE	71309128	1 20-20			6 60-30			1 50-75
		2 40-15			2 20-25			2 60-65			1 50-120
BEARING	51292	1 20-15	BEVEL GEAR	7894389	1 50-30			2 60-70	BUSH	7852114	2 10-40
		2 20-25	BOLT	700710413	24 50-5			4 60-85	BUSH	7852163	2 50-30
		1 20-30			24 50-10			4 60-90	BUSH	7852593	2 50-35
BEARING	51318	1 10-15						4 60-95	BUSH	7852742	1 50-30
BEARING	6105159	3 40-55						2 70-60	BUSH	8052177	1 10-95
BEARING	6849160	4 50-5						2 80-40			1 10-100
		4 50-10						4 80-45	BUSH	Y52316	3 50-10
BEARING	700110467P	1 10-15						8 80-50	CABLE TIE	70925442	8 80-80
BEARING	700112892	2 40-25						8 80-55	CAM	700113323P	1 50-30
		2 40-35						1 10-45	CAP	26260	2 20-60
BEARING	700704263	1 40-15						1 80-30	CAPSCREW	700707998	8 10-40
BEARING	700705612	5 20-15						2 10-25	CAPSCREW	70923114	1 50-175
BEARING	700706131	6 40-20						1 80-65			1 50-180
BEARING	700706956	1 10-40						2 80-70			1 50-185
BEARING	700720050	5 20-15						1 50-240			2 60-30
		10 20-20						1 40-40	BOX	700114079	1 10-15
BEARING	700723350	2 40-60						1 40-40	BRAKE DISC	700112875P	1 10-85
BEARING	70590709	15 20-20						1 30-50	BULB	700722351	1 10-90
BEARING	711770	1 40-55						1 30-55			1 10-90
		1 50-5						1 30-60			10 80-30
		1 50-10						1 30-65	CAPSCREW	70934842	16 60-5
BEARING	712158	1 10-95						1 30-80	CAPSCREW	8701476	12 50-5
		1 10-100						1 30-40			12 50-10
		2 40-5						1 30-45			6 50-20
		2 40-10						1 30-55			1 50-120
		1 40-15						1 30-65			1 50-125
									CARTRIDGE	700706153	2 70-20

RECOMMENDED STOCKING PARTS

D2

			Qty	PAGE				Qty	PAGE				Qty	PAGE				Qty	PAGE
CHAIN	7087935		1	10- 95	ELBOW	700706682	9	50- 175	GREASER	70923219	1	10- 5	KIT, JOINT	7732274	1	70- 35			
CHANNEL	700113235		5	20- 15			10	50- 235			1	10- 10	KIT, JOINT	7738800	1	70- 80			
CHANNEL	700138830P		10	20- 20			2	50- 240			1	10- 45	KIT, REPAIR	700150670	1	50- 125			
CIRCLIP	700718131		2	50- 10			11	50- 245			2	10- 55	KIT, REPAIR	700154471	1	30- 95			
CLEAR.SIL.310ML	LC2312031		1	10- 65	ELECTRICAL PLUG	3760032M1	1	30- 100			2	10- 60	KIT, REPAIR	700720122	1	10- 20			
			1	10- 75	FASTENER	866566	12	50- 5			2	20- 50			1	10- 30			
CLEVIS PIN	700706685		5	50- 50			12	50- 10			2	20- 55	KIT, REPAIR	7815053	2	10- 20			
			5	50- 55			6	50- 20			1	40- 25			2	10- 25			
			8	60- 5			1	50- 120			1	40- 30			2	10- 30			
CLIP	7894975		2	20- 45			1	50- 125			8	50- 15			2	10- 35			
			1	60- 15	FELT	844498	2	70- 70			1	50- 30			1	10- 40			
			1	60- 20	FILTER	7825516	1	70- 70			1	50- 100			2	80- 65			
			1	60- 25	FILTER	8799280	1	10- 65			2	60- 10			2	80- 70			
			4	60- 35			1	10- 75			4	60- 10	KIT, SEAL	700708625	1	70- 50			
			4	60- 45			2	70- 45			2	80- 50	KIT, SEAL	700710949	1	70- 65			
			8	60- 55	FINGER	700113345P	6	50- 50			2	80- 55	KIT, SEAL	700711954	1	70- 40			
			2	60- 60			6	50- 55			1	80- 60	KIT, SEAL	700715662	5	70- 20			
CLUTCH DISC	700710946		2	40- 40	FLANGE	051417P	2	20- 15	GUIDE	700139255	1	50- 90	KIT, SEAL	700715929	4	70- 25			
			2	50- 45			2	20- 20	HANDLE	7894967	2	20- 45			5	70- 30			
COIL	700706605		3	70- 20			5	20- 25			1	60- 15	KIT, SEAL	700722237	1	70- 65			
COIL	700717218		3	70- 25			1	20- 30			1	60- 20	KIT, SEAL	700723560	1	70- 80			
COIL	700725827		3	70- 30	FLANGE	6105621P	3	40- 55			1	60- 25	KNIFE	700113188P	7	40- 65			
COMP.SPRING	58511		4	20- 30	FLANGE	700711918	4	20- 55			4	60- 35	KNIFE	700715627	1	50- 35			
COMP.SPRING	858019		8	10- 40	FLANGE	714360	2	10- 95			4	60- 45			1	50- 120			
COMP.SPRING	858027		2	50- 85			4	40- 5			8	60- 55	KNIFE	700718710	1	50- 35			
			2	50- 90			2	50- 25			2	60- 60			1	50- 120			
CONNECTOR	700706683		6	50- 175	FLANGE	Y710293	30	20- 20	HOLDER	8045148	1	50- 30			1	50- 125			
			6	50- 235	FUSE	1695966M1	2	30- 95	HOOK	1712835	1	50- 35	KNOTTER	700700968	1	50- 30			
			2	50- 240			1	30- 125	HOSE	700706798	3	50- 145			1	50- 35			
			6	50- 245	FUSE	3387318M1	2	30- 95			3	50- 175			1	50- 120			
CRANK	700113239		5	20- 15			1	30- 125			3	50- 180			1	50- 125			
CRANK	700138828P		5	20- 20	FUSE	700724610	1	50- 195			3	50- 185	LAMP	700721617	3	30- 70			
CRANK	700138829P		5	20- 20	FUSE HOLDER	700724611	1	50- 195	HUB	700112925	1	10- 95			4	30- 75			
CRANKED LINK	329266M91		1	20- 15	GEAR	7894454	1	50- 30			1	10- 100	LATCH	700714528	2	20- 45			
			1	20- 20	GEAR	8802795	2	50- 85	HYDRAULIC TANK	700724605	1	50- 195			1	60- 20			
			1	20- 25			2	50- 90	IDLER	87726	1	20- 25			1	60- 25			
CRANKED LINK	329420M91		1	20- 25					KEY	700706643	1	10- 95			4	60- 40			
CRANKED LINK	329421M91		1	10- 95							1	10- 100			4	60- 50			
			1	10- 100					KIT	700122667	1	40- 20			6	60- 60			
DISC	1712868		1	50- 30					KIT	700122669	1	40- 20	LENS	71193862	4	30- 40			
DISC	700108820		4	10- 40					KIT	700710805	1	50- 235	LIGHT	700716461	2	30- 45			
			2	10- 105					KIT	700710807	1	50- 230			2	30- 55			
DISC	700711025		2	20- 30					KIT	700711425	1	10- 35			2	30- 65			
DOG	700137654P		8	60- 5					KIT	700720098	1	50- 245	LIGHT	700726172	1	30- 50			
DOG	700137655P		5	50- 50					KIT, ATTACHMENT	700114076	1	30- 90			3	30- 55			
			5	50- 55					KIT, ATTACHMENT	700114078	1	50- 120			1	30- 60			
DOWEL	863738		1	50- 35					KIT, BEARING	700720153	1	10- 30			3	30- 65			
											1	10- 35			2	30- 75			
									KIT, BOLT	700114059	1	80- 30							

RECOMMENDED STOCKING PARTS

D3

		Qty	PAGE			Qty	PAGE			Qty	PAGE			Qty	PAGE	
LINK	329264M91	1	20-15	LOCKNUT	700711238	2	10-15	LOCKNUT	Y704734	2	10-15	LOCKNUT	Y704742	4	10-5	
		1	20-20			2	10-100			4	20-10			4	10-10	
		1	20-25			23	20-15			23	20-15			4	10-15	
LINK	329277M91	1	20-25			2	20-45			60	20-15			1	10-85	
LINK	700124036P	3	40-5			6	30-15			3	20-20			7	10-90	
		3	40-10			16	30-20			90	20-20			1	20-15	
		3	40-15			7	30-25			2	20-25			3	20-25	
LINK	7088008	1	10-95			7	30-30			9	20-25			16	20-35	
LINK	86405	1	10-85			5	30-35			1	30-45			4	20-45	
		1	10-90			4	30-65			4	30-45			4	20-50	
		1	10-100			2	40-10			6	30-45			8	20-55	
LOCKING PLATE	6613624P	1	50-35			2	40-15			2	30-50			4	20-60	
		1	50-120			4	40-45			2	30-55			12	40-20	
		1	50-125			4	40-55			4	30-55			1	40-55	
LOCKNUT	700703922	1	10-10			2	50-15			6	30-55			1	50-175	
		1	20-25			17	50-65			2	30-60			1	50-180	
		2	20-55			17	50-70			2	30-65			1	50-185	
		1	40-55			1	50-105			4	30-65			10	80-30	
		9	50-10			2	50-105			6	30-65			2	80-55	
		1	50-105			5	50-105			2	40-70		MAGNET	700706340	3	30-5
		1	50-110			1	50-110			4	40-70			1	30-10	
		1	80-45			2	50-110			4	50-10			1	30-90	
		2	80-55			7	50-110			1	50-105		NEEDLE	700122690	6	50-5
		2	80-60			1	60-20			1	50-110			6	50-10	
						1	60-25			16	50-175		NIPPLE	70915276	1	10-40
						1	70-10			3	50-175			1	40-25	
						2	70-10			19	50-180			1	40-35	
						1	70-55			16	50-185			2	50-5	
						2	70-55			6	50-185			1	50-145	
						12	70-60			7	50-190			1	50-150	
						2	70-60			4	60-105			1	50-155	
				LOCKNUT	Y704635	8	80-45			9	60-135			1	50-200	
						6	50-55			4	70-5			1	50-205	
										1	70-10			1	50-210	
										2	70-10			1	50-215	
										3	70-10			1	50-220	
										2	70-15			1	50-225	
										4	70-70			3	50-235	
										8	80-40			1	80-85	
										3	80-85		NUT	700703458	24	50-5
														24	50-10	
													NUT	700710414	24	50-5
														24	50-10	
														2	50-40	
													NUT	700715751	1	40-15

RECOMMENDED STOCKING PARTS

D4

Qty	PAGE	Qty	PAGE	Qty	PAGE	Qty	PAGE
NUT	704247	2	30-75	NUT	70916950	2	20-25
		2	40-5			14	30-5
		6	40-5			2	30-5
		8	40-5			20	30-5
		16	40-10			4	30-5
		16	40-15			39	30-10
		26	40-45			4	30-75
		4	40-60			2	40-5
		4	50-5			4	40-25
		18	50-50			4	40-35
		12	50-55			1	40-45
		22	50-60			5	40-50
		6	50-65			16	40-65
		2	50-90			4	50-25
		2	50-165			6	50-50
		2	50-170			6	50-55
		5	60-15			2	50-85
		2	60-20			5	50-95
		2	60-25			10	60-5
		10	60-35			26	60-5
		10	60-40			32	60-5
		10	60-45			2	60-30
		10	60-50			6	60-30
		8	60-55			2	60-65
		2	60-60			2	60-70
		2	60-65			8	80-50
		6	60-65			8	80-55
		7	60-70			4	80-95
		8	60-85	NUT	70917421	2	40-65
		1	60-90			1	50-30
		2	60-90			6	50-50
		4	60-90	NUT	7774995	1	10-45
		2	60-95			10	80-30
		4	60-95	NUT	874404	6	50-115
		11	60-105	O RING	700706050	1	10-45
		8	60-110	O RING	700720106	1	50-195
		10	60-115	O RING	700724602	2	50-195
		6	60-120	O RING	7040330	1	10-75
NUT	704486	1	50-30	O RING	70921205	2	70-5
		1	60-30			2	70-15
						1	70-60
				O RING	70921206	1	70-55
						1	70-60
						1	70-70
				O RING	70921214	1	70-70
				O RING	70921349	3	70-20
				O RING	70921882	1	30-30
				O RING	70921885	1	70-15
				O RING	70923561	1	50-35
				O RING	831452M1	1	70-5
				OIL FILTER	7033616	1	70-70
				OIL SEAL	700716382	2	10-60
				OIL SEAL	700716383	2	10-60
				OIL SEAL	70248372	2	20-60
				PAWL	700113036	2	10-40
				PIN	700113037	2	10-40
				PIN	70922135	1	50-30
				PIN	70922598	3	50-30
						1	50-120
						1	50-125
				PIN	863753	1	20-50
						1	20-55
				PINION	702700040	1	50-30
				PLATE	6522866P	1	10-40
						1	10-105
				PLATE	6523807	1	50-30
				PLATE	700112903P	3	10-40
						1	10-105
				PRINTED CIRCUIT	700724601	1	50-195
				RECEIVER	700714529	2	20-45
						1	60-20
						1	60-25
						4	60-40
						4	60-50
						6	60-60
				REFLECTOR	8722894	6	50-115
				RING	70927700	2	40-25
						2	40-35
				RING	738633	2	50-20
				RING	7852148	2	40-25
				ROD	6523740P	6	50-50
						6	50-55
				ROD	700706503	6	50-115
				ROD	702400048	6	50-50
						6	50-60
						6	50-65
				ROLL OF CHAIN	W980268US	1	10-85
						1	10-90
						1	10-100
				ROLLER	6524623P	1	50-40
				ROLLER	6524870P	1	40-50
						1	50-95
				ROLLER	6529945	6	50-20
						1	50-75
						1	50-120
				ROLLER	700122799	1	50-35
				ROLLER	700138225	1	50-100
				SCREW	7883374	1	30-45
						2	30-55
						2	30-65
						3	60-70
						4	60-85
						4	60-90
						4	60-95
						4	60-105
				SCREW	8701781	2	50-85
						2	50-90
				SCREW	Y703132	4	40-5
						4	40-10
						4	40-15
						5	40-45
				SCREW	Y706549	6	50-115
				SEAL	700706045	1	10-45
						2	10-70
						2	10-80
				SEAL	700706096	6	40-20
				SEAL	700716267	2	10-90
				SEAL	700718774	1	70-65
				SEAL	700723562	1	70-80
				SEAL	8044695	12	50-50
						12	50-55
				SENSOR	700706398	4	30-5
						4	30-10
						5	30-30
						1	30-90
						1	30-95
				SENSOR	71393718	1	10-75
				SETSCREW	70923306	2	50-40
				SHAFT	6553267	1	50-30
				SHAFT	6591580	1	50-35
				SHAFT	700138835P	5	20-20
				SHIELD	6530471P	2	50-95
				SHIELD	700712446	1	10-20
						1	80-65
				SHIM	6522932	2	10-40
				SHIM	6553275	2	50-30
						9	50-45
				SLEEVE	6526081	1	10-85
						1	10-90
				SLEEVE	7849656	6	50-20
						1	50-75
						1	50-120
				SLEEVE	7852718	1	10-45
				SNAPRING	355919X1	1	50-25
						1	50-40
				SNAPRING	70927699	1	10-40

RECOMMENDED STOCKING PARTS

D5

		Qty	PAGE			Qty	PAGE			Qty	PAGE			Qty	PAGE
SNAPRING	70927728	1	50-35	SWITCH	700119161	2	30-10	WASHER	705541	4	10-5	WASHER	Y705525	23	20-40
SNAPRING	70927732	2	40-50			1	30-20			4	10-10			2	20-45
		1	50-30			1	30-25			4	10-15			6	20-45
		2	50-95			1	30-95			1	10-85			4	30-15
		2	50-100	SWITCH	700710208	1	30-25			1	10-90			1	30-20
SNAPRING	70927744	1	50-90	SWITCH	700724612	1	50-195			1	20-20			2	30-30
SOLENOID	700710176	3	70-20	TENSION SPRING	700712484	1	50-20			1	20-25			2	30-35
SOLENOID VALVE	1079721M1	2	70-25	TENSION SPRING	758268	1	40-30			4	20-45			2	30-40
		2	70-30			1	50-40			4	20-60			2	50-195
SPACER	2401516P	1	50-110	TENSION SPRING	758441	1	50-95			8	20-60			6	60-15
SPACER	6530828P	2	50-85			1	50-105			1	40-50			1	60-20
SPACER	700137750P	5	20-15	TENSION SPRING	758482	6	50-20			10	40-65			2	60-20
		10	20-20	TENSIONER	7895733	1	50-30			4	40-65			5	60-20
SPRING	58107B	8	10-105	THERMOSTAT	700716952	1	10-75			24	50-5			1	60-25
		8	20-30	TIE	70925094	4	30-5			24	50-10			2	60-25
SPRING	58644	10	50-45			4	30-10			2	50-15			5	60-25
		1	50-105			1	30-15			4	50-20			6	60-25
		1	50-110			1	30-20			4	50-25			2	60-30
		1	60-90			5	30-25			2	50-95			10	60-35
SPRING	58941	1	60-75			2	30-35			4	50-105			6	60-40
		1	60-80			1	30-40			4	50-110			10	60-45
SPRING	6522700P	2	20-50			1	30-50			2	80-45			6	60-50
		2	20-55			8	30-55							4	60-60
SPRING	6553259P	2	50-30			1	30-60							20	60-65
SPRING	700714166	1	50-100			8	30-65							2	60-90
SPRING	758011	10	40-40			X	30-70							5	70-5
SPRING	7758212	2	20-45			18	30-75							4	70-10
		1	60-15			2	30-85							10	70-15
		1	60-20			36	50-135							3	70-45
		1	60-25			18	50-140							2	70-55
		4	60-35			5	50-160							3	70-55
		4	60-45			3	50-180								
		8	60-55			1	50-190								
		2	60-60			12	60-135								
SPRING	7758758	1	40-25			4	80-85								
		1	40-35	TINE	700714199B	60	20-15								
SPRING	858308	2	20-35			60	20-20								
		1	40-50	TRANSDUCER	700720228	1	30-5								
		2	50-20			1	30-10								
SPROCKET	47142	1	20-15	TRANSDUCER	700722199	1	30-30								
		4	20-20	UNION	70919171	3	50-180								
		3	20-25			3	80-85								
SPROCKET	Y747931	1	10-95	UNIVERSAL JOINT	700712443	1	10-20								
STRIPPER	700138858	1	50-30			1	80-65								
STUD	6523229	1	50-30	V BELT	700718206	1	70-60								
SWITCH	3901306M1	1	30-80	WASHER	6591572	1	50-35								
SWITCH	700113863	3	30-5												
		1	30-10												
		1	30-90												

RECOMMENDED STOCKING PARTS

D6

		Qty	PAGE
WASHER	Y705533	4	10- 15
		8	20- 10
		60	20- 15
		60	20- 20
		2	20- 25
		5	20- 40
		3	30- 15
		3	30- 20
		1	30- 25
		X	30- 40
		3	30- 70
		2	30- 75
		4	30- 75
		2	40- 5
		2	40- 10
		2	40- 15
		4	40- 45
		4	40- 50
		15	40- 65
		16	40- 65
		2	50- 15
		4	50- 25
		2	50- 95
		2	50- 105
		5	50- 105
		2	50- 110
		7	50- 110
		26	60- 5
		2	60- 25
		2	60- 30
		6	60- 30
		2	60- 65
		2	60- 70
1	70- 10		
2	70- 10		
2	70- 60		
6	80- 45		
WORM GEAR	7894413	1	50- 30
WRAPPER	700113244P	25	20- 10

Qty PAGE

Qty PAGE

Qty PAGE

PIECES DONT LE STOCKAGE EST RECOMMANDE

D7

		Qty	PAGE			Qty	PAGE			Qty	PAGE			Qty	PAGE
AGRAFE	866566	12	50-5	ATTACHE	70925094	4	30-5	BAGUE	8052177	1	10-95	BOULON	70922786	2	10-15
		12	50-10			4	30-10			1	10-100			2	10-100
		6	50-20			1	30-15	BAGUE	Y52316	3	50-10			3	20-15
		1	50-120			1	30-20	BAGUE ETANCHEITE	700716382	2	10-60			55	20-15
		1	50-125			5	30-25	BAGUE ETANCHEITE	700716383	2	10-60			40	20-20
AIGUILLE	700122690	6	50-5			2	30-35	BAGUE ETANCHEITE	70248372	2	20-60			6	20-25
		6	50-10			1	30-40	BARBOTIN	47142	1	20-15			6	40-5
AIMANT	700706340	3	30-5			1	30-50			4	20-20			8	40-10
		1	30-10			8	30-55			3	20-25			8	40-15
		1	30-90			1	30-60	BARBOTIN	Y747931	1	10-95			16	40-45
AMPOULE	700722351	1	30-50			8	30-65	BARRE	700113189	7	40-65			4	40-55
		1	30-55			X	30-70	BOBINE	700706605	3	70-20			16	40-65
		1	30-60			18	30-75	BOBINE	700717218	3	70-25			2	40-70
		1	30-65			2	30-85	BOBINE	700725827	3	70-30			6	50-50
AMPOULE 12V	3405180M1	1	30-80			36	50-135	BOITE	700114079	1	50-240			6	50-55
AMPOULE 12V 21W	621235M1	4	30-40			18	50-140	BORNE	700706683	6	50-175			4	50-65
		1	30-45			5	50-160			6	50-235			4	50-70
		1	30-55			3	50-180			2	50-240			5	50-105
		1	30-65			1	50-190			6	50-245			7	50-110
AMPOULE 21/5W	908543M1	1	30-45			12	60-135	BOULON	700710413	24	50-5			1	60-20
		1	30-55			4	80-85			24	50-10			1	60-25
		1	30-65	ATTACHE CABLE	70925442	8	80-80							6	60-30
ANNEAU	70927700	2	40-25	AXE	700706685	5	50-50							2	60-65
		2	40-35			5	50-55							2	60-70
ANNEAU	738633	2	50-20			8	60-5							4	60-85
ANNEAU	7852148	2	40-25	BAGUE	52761	8	60-10							4	60-90
		1	40-35	BAGUE	6523500	7	50-25							4	60-95
ARBRE	6553267	1	50-30			3	50-40							2	70-60
ARBRE	6591580	1	50-35	BAGUE	6523799	1	30-20							2	80-40
ARBRE	700138835P	5	20-20			10	50-20							4	80-45
				BAGUE	6565030	1	10-105							8	80-50
				BAGUE	700122681P	6	50-50							8	80-55
						6	50-55							2	10-25
				BAGUE	700124038	12	40-5					BOULON UNC	354289X1	1	80-65
						12	40-10							2	80-70
						12	40-15							2	10-40
				BAGUE	70936273	1	60-10					CALE REGLAGE	6522932	2	50-30
				BAGUE	712810	1	40-25					CALE REGLAGE	6553275	2	50-45
						1	40-35							9	50-45
						2	50-5					CAME	700113323P	1	50-30
						2	50-10					CANAL	700113235	5	20-15
				BAGUE	7849110	6	50-20					CANAL	700138830P	10	20-20
						1	50-75					CAPTEUR	700720228	1	30-5
						1	50-120							1	30-10
				BAGUE	7852114	2	10-40					CAPTEUR	700722199	1	30-30
				BAGUE	7852163	2	50-30					CARDAN	700712443	1	10-20
				BAGUE	7852593	2	50-35							1	80-65
				BAGUE	7852742	1	50-30					CARTOUCHE	700706153	2	70-20
												CATADIOPTRE	8722894	6	50-115
												CHAINE	7087935	1	10-95

PIECES DONT LE STOCKAGE EST RECOMMANDE

D8

		Qty	PAGE			Qty	PAGE			Qty	PAGE			Qty	PAGE
CHAPEAU	26260	2	20-60	COUSSINET	700720050	5	20-15	DISQUE EMBRAYAGE	700710946	2	40-40	ECROU	704247	2	30-75
CHIEN	700137654P	8	60-5			10	20-20			2	50-45			2	40-5
CHIEN	700137655P	5	50-50	COUSSINET	700723350	2	40-60	DOIGT	700113345P	6	50-50			6	40-5
		5	50-55	COUSSINET	70590709	15	20-20			6	50-55			8	40-5
CIRCLIP	700718131	2	50-10	COUSSINET	711770	1	40-55	DURITE	700706798	3	50-145			16	40-10
CIRCUIT IMPRIME	700724601	1	50-195			1	50-5			3	50-175			16	40-15
CLAVETTE	700706643	1	10-95	COUSSINET	712158	1	50-10			3	50-180			26	40-45
		1	10-100			1	10-95	ECROU	700703458	3	50-185			4	40-60
CLEAR.SIL.310ML	LC2312031	1	10-65			1	10-100			24	50-5			4	50-5
		1	10-75			2	40-5	ECROU	700710414	24	50-10			18	50-50
CLIP	7894975	2	20-45			2	40-10			24	50-5			12	50-55
		1	60-15			1	40-15			24	50-10			22	50-60
		1	60-20	COUSSINET	7713829	2	40-65			2	50-40			6	50-65
		1	60-25	COUSSINET	7713837	1	40-25	ECROU	700715751	1	40-15			2	50-90
		4	60-35			1	40-35							2	50-165
		4	60-45	COUSSINET	8050478	1	50-25							2	50-170
		8	60-55	COUSSINET	8050866	2	50-20							5	60-15
		2	60-60	COUSSINET	Y710392	10	20-15							2	60-20
CONE ROULEMENT	700706039	2	10-45	COUTEAU	700113188P	7	40-65							2	60-25
CONE ROULEMENT	70341230	4	20-60	COUTEAU	700715627	1	50-35							10	60-35
CONE ROULEMENT	70927347	2	10-90			1	50-120							10	60-40
COUDE	700706682	9	50-175	COUTEAU	700718710	1	50-35							10	60-45
		10	50-235			1	50-120							10	60-50
		2	50-240			1	50-125							8	60-55
		11	50-245	COUVERTURE	700113244P	25	20-10							2	60-60
COURONNE CONIQUE	7894389	1	50-30	CROCHET	1712835	1	50-35							2	60-65
COURROIE TRAPEZ	700718206	1	70-60	CUVETTE ROULEMNT	700706038	2	10-45							6	60-65
COUSSINET	1109055	2	40-5	CUVETTE ROULEMNT	70927348	2	10-90							7	60-70
		6	40-10	CUVETTE ROULEMNT	832190M1	4	20-60							8	60-85
		2	40-15	DEBOURREUR	700138858	1	50-30							1	60-90
COUSSINET	1124697	1	10-40	DECLENCHEUR	700709996	1	30-25							2	60-90
COUSSINET	50393	2	40-5	DECLENCHEUR	700710211	2	30-10							4	60-90
		2	40-10			1	30-20							2	60-95
		2	40-15			2	30-25							4	60-95
COUSSINET	51292	1	20-15			1	30-95							11	60-105
		2	20-25	DENT A RESSORT	700714199B	60	20-15							8	60-110
		1	20-30			60	20-20							10	60-115
COUSSINET	51318	1	10-15	DETECTEUR	700706398	4	30-5							6	60-120
COUSSINET	6105159	3	40-55			4	30-10					ECROU	704486	1	50-30
COUSSINET	6849160	4	50-5			5	30-30							1	60-30
		4	50-10			1	30-90								
COUSSINET	700110467P	1	10-15			1	30-95								
COUSSINET	700112892	2	40-25	DETECTEUR	71393718	1	10-75								
		2	40-35	DISQUE	1712868	1	50-30								
COUSSINET	700704263	1	40-15	DISQUE	700108820	4	10-40								
COUSSINET	700705612	5	20-15			2	10-105								
COUSSINET	700706131	6	40-20	DISQUE	700711025	2	20-30								
COUSSINET	700706956	1	10-40	DISQUE DE FREIN	700112875P	1	40-40								

PIECES DONT LE STOCKAGE EST RECOMMANDE

D9

		Qty	PAGE			Qty	PAGE			Qty	PAGE			Qty	PAGE
ECROU	70916950	2	20-25	ECROU BLOCAGE	700711238	2	10-15	ECROU BLOCAGE	Y704734	2	10-15	ECROU BLOCAGE	Y704742	4	10-5
		14	30-5			2	10-100			4	20-10			4	10-10
		2	30-5			23	20-15			23	20-15			4	10-15
		20	30-5			2	20-45			60	20-15			1	10-85
		4	30-5			6	30-15			3	20-20			7	10-90
		39	30-10			16	30-20			90	20-20			1	20-15
		4	30-75			7	30-25			2	20-25			3	20-25
		2	40-5			7	30-30			9	20-25			16	20-35
		4	40-25			5	30-35			1	30-45			4	20-45
		4	40-35			4	30-65			4	30-45			4	20-50
		1	40-45			2	40-10			6	30-45			8	20-55
		5	40-50			2	40-15			2	30-50			4	20-60
		16	40-65			4	40-45			2	30-55			12	40-20
		4	50-25			4	40-55			4	30-55			1	40-55
		6	50-50			2	50-15			6	30-55			1	50-175
		6	50-55			17	50-65			2	30-60			1	50-180
		2	50-85			17	50-70			2	30-65			1	50-185
		5	50-95			1	50-105			4	30-65			10	80-30
		10	60-5			2	50-105			6	30-65			2	80-55
		26	60-5			5	50-105			2	40-70	ENGRENAGE	7894454	1	50-30
		32	60-5			1	50-110			4	40-70	ENGRENAGE	8802795	2	50-85
		2	60-30			2	50-110			4	50-10			2	50-90
		6	60-30			7	50-110			1	50-105	ENSEMBLE BOULON	6521868	1	10-45
		2	60-65			1	60-20			1	50-110			1	80-30
		2	60-70			1	60-25			16	50-175	ENTRETOISE	2401516P	1	50-110
		8	80-50			1	70-10			3	50-175	ENTRETOISE	6530828P	2	50-85
		8	80-55			2	70-10			19	50-180	ENTRETOISE	700137750P	5	20-15
		4	80-95			1	70-55			16	50-185			10	20-20
ECROU	70917421	2	40-65			2	70-55			6	50-185	FEU	700716461	2	30-45
		1	50-30			12	70-60			7	50-190			2	30-55
		6	50-50			2	70-60			4	60-105			2	30-65
ECROU	7774995	1	10-45			8	80-45			9	60-135	FEU	700726172	1	30-50
		10	80-30	ECROU BLOCAGE	Y704635	6	50-55			4	70-5			3	30-55
ECROU	874404	6	50-115							1	70-10			1	30-60
ECROU BLOCAGE	700703922	1	10-10							2	70-10			3	30-65
		1	20-25							3	70-10			2	30-75
		2	20-55							2	70-15	FEUTRE	844498	2	70-70
		1	40-55							4	70-70	FILTRE	7825516	1	70-70
		9	50-10							8	80-40	FILTRE	8799280	1	10-65
		1	50-105							3	80-85			1	10-75
		1	50-110											2	70-45
		1	80-45									FILTRE HUILE	7033616	1	70-70
		2	80-55									FLASQUE	051417P	2	20-15
		2	80-60											2	20-20
														5	20-25
														1	20-30
												FLASQUE	6105621P	3	40-55
												FLASQUE	700711918	4	20-55

PIECES DONT LE STOCKAGE EST RECOMMANDE

D10

			Qty	PAGE				Qty	PAGE				Qty	PAGE				Qty	PAGE		
FLASQUE	714360	2	10-95	GRAISSEUR	70923219	1	10-5	JEU ACCESSOIRES	700114076	1	30-90	JOINT TORIQUE	70923561	1	50-35						
		4	40-5			1	10-10	JEU ACCESSOIRES	700114078	1	50-120	JOINT TORIQUE	831452M1	1	70-5						
		2	50-25			1	10-45	JEU BOULONS	700114059	1	80-30	LENTILLE	71193862	4	30-40						
FLASQUE	Y710293	30	20-20			2	10-55	JEU COUSSINETS	700720153	1	10-30	LINGUET	700113036	2	10-40						
FLASQUE ROULT	700108622P	10	20-15			2	10-60			1	10-35	MAILLON	329264M91	1	20-15						
FLASQUE ROULT	700109753P	1	10-95			2	20-50	JEU ETANCHEITE	700708625	1	70-50			1	20-20						
		1	10-100			2	20-55	JEU ETANCHEITE	700710949	1	70-65			1	20-25						
		4	40-10			1	40-25	JEU ETANCHEITE	700711954	1	70-40	MAILLON	329277M91	1	20-25						
		1	40-15			1	40-30	JEU ETANCHEITE	700715662	5	70-20	MAILLON	700124036P	3	40-5						
FLASQUE ROULT	700715941	1	50-80			8	50-15	JEU ETANCHEITE	700715929	4	70-25			3	40-10						
FLASQUE ROULT	700716611	1	40-15			1	50-30			5	70-30			3	40-15						
FLASQUE ROULT	71122510	2	20-55			1	50-100	JEU ETANCHEITE	700722237	1	70-65	MAILLON	7088008	1	10-95						
FLASQUE ROULT	71309128	1	20-20			2	60-10	JEU ETANCHEITE	700723560	1	70-80	MAILLON	86405	1	10-85						
		2	20-25			4	60-10	JEU JOINTS	7732274	1	70-35			1	10-90						
FUSIBLE	1695966M1	2	30-95			2	80-50	JEU JOINTS	7738800	1	70-80			1	10-100						
		1	30-125			2	80-55	JEU REPARATION	700150670	1	50-125	MAILLON COUDE	329266M91	1	20-15						
FUSIBLE	3387318M1	2	30-95			1	80-60	JEU REPARATION	700154471	1	30-95			1	20-20						
		1	30-125	GRAISSEUR COUDE	70915276	1	10-40	JEU REPARATION	700720122	1	10-20			1	20-25						
FUSIBLE	700724610	1	50-195			1	40-25			1	10-30	MAILLON COUDE	329420M91	1	20-25						
GALET	6524623P	1	50-40			1	40-35	JEU REPARATION	7815053	2	10-20	MAILLON COUDE	329421M91	1	10-95						
GALET	6524870P	1	40-50			2	50-5			2	10-25			1	10-100						
		1	50-95			1	50-145			2	10-30	MANCHON	6526081	1	10-85						
GALET	6529945	6	50-20			1	50-150			2	10-35			1	10-90						
		1	50-75			1	50-155			1	10-40	MANCHON	7849656	6	50-20						
		1	50-120			1	50-200			2	80-65			1	50-75						
GALET	700122799	1	50-35			1	50-205			2	80-70			1	50-120						
GALET	700138225	1	50-100			1	50-210	JOINT ETANCHEITE	700706045	1	10-45	MANCHON	7852718	1	10-45						
GOUJON	6523229	1	50-30			1	50-215			2	10-70	MANIVELLE	700113239	5	20-15						
GOUPIILLE	700113037	2	10-40			1	50-220			2	10-80	MANIVELLE	700138828P	5	20-20						
GOUPIILLE	70922135	1	50-30			1	50-225	JOINT ETANCHEITE	700706096	6	40-20	MANIVELLE	700138829P	5	20-20						
GOUPIILLE	70922598	3	50-30			3	50-235	JOINT ETANCHEITE	700716267	2	10-90	MOYEU	700112925	1	10-95						
		1	50-120			1	80-85	JOINT ETANCHEITE	700718774	1	70-65			1	10-100						
		1	50-125	GUIDE	700139255	1	50-90	JOINT ETANCHEITE	700723562	1	70-80	NOUEUR	700700968	1	50-30						
GOUPIILLE	863753	1	20-50	INTERRUPTEUR	3901306M1	1	30-80	JOINT ETANCHEITE	8044695	12	50-50			1	50-35						
		1	20-55	INTERRUPTEUR	700113863	3	30-5			12	50-55			1	50-120						
						1	30-10	JOINT TORIQUE	700706050	1	10-45			1	50-125						
						1	30-90	JOINT TORIQUE	700720106	1	50-195	PARE CHOC	827568	1	40-55						
				INTERRUPTEUR	700119161	2	30-10	JOINT TORIQUE	700724602	2	50-195	PHARE	700721617	3	30-70						
						1	30-20	JOINT TORIQUE	7040330	1	10-75			4	30-75						
						1	30-25	JOINT TORIQUE	70921205	2	70-5	PIECE SUPPORT	8045148	1	50-30						
						1	30-95			2	70-15	PIGNON	702700040	1	50-30						
				INTERRUPTEUR	700710208	1	30-25			1	70-60	PIGNON HELICOIDA	7894413	1	50-30						
				INTERRUPTEUR	700724612	1	50-195	JOINT TORIQUE	70921206	1	70-55	PLAQUE	6522866P	1	10-40						
				JEU	700122667	1	40-20			1	70-60			1	10-105						
				JEU	700122669	1	40-20			1	70-70	PLAQUE	6523807	1	50-30						
				JEU	700710805	1	50-235	JOINT TORIQUE	70921214	1	70-70	PLAQUE	700112903P	3	10-40						
				JEU	700710807	1	50-230	JOINT TORIQUE	70921349	3	70-20			1	10-105						
				JEU	700711425	1	10-35	JOINT TORIQUE	70921882	1	30-30										
				JEU	700720098	1	50-245	JOINT TORIQUE	70921885	1	70-15										

PIECES DONT LE STOCKAGE EST RECOMMANDE

D11

		Qty	PAGE			Qty	PAGE			Qty	PAGE			Qty	PAGE
PLAQUE BLOCAGE	6613624P	1	50-35	RESSORT	858308	2	20-35	RONDELLE	Y705525	23	20-40	RONDELLE	Y705533	4	10-15
		1	50-120			1	40-50			2	20-45			8	20-10
		1	50-125			2	50-20			6	20-45			60	20-15
PLOT	863738	1	50-35	RESSORT DE COMPR	58511	4	20-30			4	30-15			60	20-20
POIGNEE	7894967	2	20-45	RESSORT DE COMPR	858019	8	10-40			1	30-20			2	20-25
		1	60-15	RESSORT DE COMPR	858027	2	50-85			2	30-30			5	20-40
		1	60-20			2	50-90			2	30-35			3	30-15
		1	60-25	RESSORT TRACTION	700712484	1	50-20			2	30-40			3	30-20
		4	60-35	RESSORT TRACTION	758268	1	40-30			2	50-195			1	30-25
		4	60-45			1	50-40			6	60-15			X	30-40
		8	60-55	RESSORT TRACTION	758441	1	50-95			1	60-20			3	30-70
		2	60-60			1	50-105			2	60-20			2	30-75
PORTE FUSIBLE	700724611	1	50-195	RESSORT TRACTION	758482	6	50-20			5	60-20			4	30-75
POULIE TENSION	87726	1	20-25	RONDELLE	6591572	1	50-35			1	60-25			2	40-5
PRISE ELECT MALE	3760032M1	1	30-100	RONDELLE	705541	4	10-5			2	60-25			2	40-10
RACCORD	70919171	3	50-180			4	10-10			5	60-25			2	40-15
		3	80-85			4	10-15			6	60-25			4	40-45
RECEVEUR	700714529	2	20-45			1	10-85			2	60-30			4	40-50
		1	60-20			1	10-90			10	60-35			15	40-65
		1	60-25			1	20-20			6	60-40			16	40-65
		4	60-40			1	20-25			10	60-45			2	50-15
		4	60-50			4	20-45			6	60-50			4	50-25
		6	60-60			4	20-60			4	60-60			2	50-95
RESERVOIR HYDR	700724605	1	50-195			8	20-60			20	60-65			2	50-105
RESSORT	58107B	8	10-105			1	40-50			2	60-90			5	50-105
		8	20-30			10	40-65			5	70-5			2	50-110
RESSORT	58644	10	50-45			4	40-65			4	70-10			7	50-110
		1	50-105			24	50-5			10	70-15			26	60-5
		1	50-110			24	50-10			3	70-45			2	60-25
		1	60-90			2	50-15			2	70-55			2	60-30
RESSORT	58941	1	60-75			4	50-20			3	70-55			6	60-30
		1	60-80			4	50-25							2	60-65
RESSORT	6522700P	2	20-50			2	50-95							2	60-70
		2	20-55			4	50-105							1	70-10
RESSORT	6553259P	2	50-30			4	50-110							2	70-10
RESSORT	700714166	1	50-100			2	80-45							2	70-60
RESSORT	758011	10	40-40											6	80-45
RESSORT	7758212	2	20-45											1	10-85
		1	60-15											1	10-90
		1	60-20											1	10-100
		1	60-25											4	40-65
		4	60-35											12	50-5
		4	60-45											12	50-10
		8	60-55											1	50-20
		2	60-60											6	50-20
RESSORT	7758758	1	40-25											1	50-80
		1	40-35											1	50-120
														1	50-125

LAGERVORSCHLAGSTEILE

D13

		Qty	PAGE			Qty	PAGE			Qty	PAGE			Qty	PAGE
ABSTANDSTUECK	2401516P	1	50-110	CLEAR.SIL.310ML	LC2312031	1	10-65	FEDER	58644	10	50-45	FLANSCH	051417P	2	20-15
ABSTANDSTUECK	6530828P	2	50-85			1	10-75			1	50-105			2	20-20
ABSTANDSTUECK	700137750P	5	20-15	DICHTRING	700706045	1	10-45			1	50-110			5	20-25
		10	20-20			2	10-70			1	60-90			1	20-30
ABSTREIFER	700138858	1	50-30			2	10-80	FEDER	58941	1	60-75	FLANSCH	6105621P	3	40-55
BETAETIGUNG	700709996	1	30-25	DICHTRING	700706096	6	40-20			1	60-80	FLANSCH	700711918	4	20-55
BETAETIGUNG	700710211	2	30-10	DICHTRING	700716267	2	10-90	FEDER	6522700P	2	20-50	FLANSCH	714360	2	10-95
		1	30-20	DICHTRING	700718774	1	70-65			2	20-55			4	40-5
		2	30-25	DICHTRING	700723562	1	70-80	FEDER	6553259P	2	50-30			2	50-25
		1	30-95	DICHTRING	8044695	12	50-50	FEDER	700714166	1	50-100	FLANSCH	Y710293	30	20-20
BINDER	700700968	1	50-30			12	50-55	FEDER	758011	10	40-40	FUEHRUNG	700139255	1	50-90
		1	50-35	DICHTRINGSATZ	700708625	1	70-50	FEDER	7758212	2	20-45	FUSSPLATTE	700102136	1	50-35
		1	50-120	DICHTRINGSATZ	700710949	1	70-65			1	60-15	GEDRUCKTESCHALTG	700724601	1	50-195
		1	50-125	DICHTRINGSATZ	700711954	1	70-40			1	60-20	GEKROEPFTESGLIED	329266M91	1	20-15
BOLZEN	700113037	2	10-40	DICHTRINGSATZ	700715662	5	70-20			1	60-25			1	20-20
BOLZEN	70922135	1	50-30	DICHTRINGSATZ	700715929	4	70-25			4	60-35			1	20-25
BOLZEN	70922598	3	50-30			5	70-30			4	60-45	GEKROEPFTESGLIED	329420M91	1	20-25
		1	50-120	DICHTRINGSATZ	700722237	1	70-65			8	60-55	GEKROEPFTESGLIED	329421M91	1	10-95
		1	50-125	DICHTRINGSATZ	700723560	1	70-80			2	60-60			1	10-100
BOLZEN	863753	1	20-50	DICHTUNGSSATZ	7732274	1	70-35	FEDER	7758758	1	40-25	GLIED	329264M91	1	20-15
		1	20-55	DICHTUNGSSATZ	7738800	1	70-80			1	40-35			1	20-20
BREMSSSCHEIBE	700112875P	1	40-40	DOPPELNIPPEL	700706683	6	50-175	FEDER	858308	2	20-35			1	20-25
BUCHSE	52761	8	60-10			6	50-235			1	40-50	GLIED	329277M91	1	20-25
BUCHSE	6523500	7	50-25			2	50-240			2	50-20	GLIED	700124036P	3	40-5
		3	50-40			6	50-245	FETTNIPPEL	70923219	1	10-5			3	40-10
BUCHSE	6523799	1	30-20	DOSE	700114079	1	50-240			1	10-10			3	40-15
		10	50-20	DRUCKFEDER	58511	4	20-30			1	10-45	GLIED	7088008	1	10-95
BUCHSE	6565030	1	10-105	DRUCKFEDER	858019	8	10-40			2	10-55	GLIED	86405	1	10-85
BUCHSE	700122681P	6	50-50	DRUCKFEDER	858027	2	50-85			2	10-60			1	10-90
		6	50-55			2	50-90			2	20-50			1	10-100
BUCHSE	700124038	12	40-5	EINSTELLBLECH	6522932	2	10-40			2	20-55	GLUEHL 12V21WSBC	621235M1	4	30-40
		12	40-10	EINSTELLBLECH	6553275	2	50-30			1	40-25			1	30-45
		12	40-15			9	50-45			1	40-30			1	30-55
BUCHSE	70936273	1	60-10	EMPFAENGER	700714529	2	20-45			8	50-15			1	30-65
BUCHSE	712810	1	40-25			1	60-20			1	50-30	GLUEHLAMPE	700722351	1	30-50
		1	40-35			1	60-25			1	50-100			1	30-55
		2	50-5			4	60-40			2	60-10			1	30-60
		2	50-10			4	60-50			4	60-10			1	30-65
BUCHSE	7849110	6	50-20			6	60-60			2	80-50	GLUEHLAMPE 12V	3405180M1	1	30-80
		1	50-75	EMPFANGER	700706398	4	30-5			2	80-55	GLUEHLAMPE 21/SW	908543M1	1	30-45
		1	50-120			4	30-10			1	80-60			1	30-55
BUCHSE	7852114	2	10-40			5	30-30	FILTER	7825516	1	70-70			1	30-65
BUCHSE	7852163	2	50-30			1	30-90	FILTER	8799280	1	10-65	HAKEN	1712835	1	50-35
BUCHSE	7852593	2	50-35			1	30-95			1	10-75	HALTEKLAMMER	866566	12	50-5
BUCHSE	7852742	1	50-30	EMPFANGER	71393718	1	10-75			2	70-45			12	50-10
BUCHSE	8052177	1	10-95	FEDER	58107B	8	10-105	FILZ	844498	2	70-70			6	50-20
		1	10-100			8	20-30	FINGER	700113345P	6	50-50			1	50-120
BUCHSE	Y52316	3	50-10							6	50-55			1	50-125
												HALTER	8045148	1	50-30

LAGERVORSCHLAGSTEILE

D14

	Qty	PAGE		Qty	PAGE		Qty	PAGE		Qty	PAGE				
HANDGRIFF	7894967	2	20-45	KNICKSCHUTZFEDER	700706605	3	70-20	LAGER	6105159	3	40-55	LEUCHTE	700716461	2	30-45
		1	60-15	KNICKSCHUTZFEDER	700717218	3	70-25	LAGER	6849160	4	50-5			2	30-55
		1	60-20	KNICKSCHUTZFEDER	700725827	3	70-30			4	50-10			2	30-65
		1	60-25	KUGELLAGER	700722661	12	50-5	LAGER	700110467P	1	10-15	LEUCHTE	700726172	1	30-50
		4	60-35			12	50-10	LAGER	700112892	2	40-25			3	30-55
		4	60-45			1	50-20			2	40-35			1	30-60
		8	60-55			6	50-20	LAGER	700704263	1	40-15			3	30-65
		2	60-60			1	50-80	LAGER	700705612	5	20-15			2	30-75
HUELSE	6526081	1	10-85			1	50-120	LAGER	700706131	6	40-20	LINSE	71193862	4	30-40
		1	10-90			1	50-125	LAGER	700706956	1	10-40	MAGNET	700706340	3	30-5
HUELSE	7849656	6	50-20	KUGELLAGER	70575883	4	20-35	LAGER	700720050	5	20-15			1	30-10
		1	50-75			4	20-40			10	20-20			1	30-90
		1	50-120	KUPPL.STANGE	70925094	4	30-5	LAGER	700723350	2	40-60	MAGNETSPULE	700710176	3	70-20
HUELSE	7852718	1	10-45			4	30-10	LAGER	70590709	15	20-20	MAGNETVENTIL	1079721M1	2	70-25
HUTSCHRAUBE	700707998	8	10-40			1	30-15	LAGER	711770	1	40-55			2	70-30
HUTSCHRAUBE	70923114	1	50-175			1	30-20			1	50-5	MASCH.SCHRAUBE	700710413	24	50-5
		1	50-180			5	30-25			1	50-10			24	50-10
		1	50-185			2	30-35	LAGER	712158	1	10-95	MASCH.SCHRAUBE	70922786	2	10-15
		2	60-30			1	30-40			1	10-100			2	10-100
HUTSCHRAUBE	70923161	1	10-15			1	30-50			2	40-5			3	20-15
HUTSCHRAUBE	70924666	1	10-85			8	30-55			2	40-10			55	20-15
		1	10-90			1	30-60			1	40-15			40	20-20
		10	80-30			8	30-65	LAGER	7713829	2	40-65			6	20-25
HUTSCHRAUBE	70934842	16	60-5			X	30-70	LAGER	7713837	1	40-25			6	40-5
HUTSCHRAUBE	8701476	12	50-5			18	30-75			1	40-35			8	40-10
		12	50-10			2	30-85	LAGER	8050478	1	50-25			8	40-15
		6	50-20			36	50-135	LAGER	8050866	2	50-20			16	40-45
		1	50-120			18	50-140	LAGER	Y710392	10	20-15			4	40-55
		1	50-125			5	50-160	LAGERAUSSENRING	700706038	2	10-45			16	40-65
HYDRAULIKTANK	700724605	1	50-195			3	50-180	LAGERAUSSENRING	70927348	2	10-90			2	40-70
KABELBINDER	70925442	8	80-80			1	50-190	LAGERAUSSENRING	832190M1	4	20-60			6	50-50
KANAL	700113235	5	20-15			12	60-135	LAGERFLANSCH	700108622P	10	20-15			6	50-55
KANAL	700138830P	10	20-20			4	80-85	LAGERFLANSCH	700109753P	1	10-95			4	50-65
KAPPE	26260	2	20-60	KUPPLUNGSSCHEIBE	700710946	2	40-40			1	10-100			4	50-70
KARDANGELENK	700712443	1	10-20			2	50-45			4	40-10			5	50-105
		1	80-65	KURBEL	700113239	5	20-15			1	40-15			7	50-110
KEGELRAD	7894389	1	50-30	KURBEL	700138828P	5	20-20	LAGERFLANSCH	700715941	1	50-80			1	60-20
KEILRIEMEN	700718206	1	70-60	KURBEL	700138829P	5	20-20	LAGERFLANSCH	700716611	1	40-15			1	60-25
KETTE	7087935	1	10-95	LAGER	1109055	2	40-5	LAGERFLANSCH	71122510	2	20-55			6	60-30
KETTE METERWARE	W980268US	1	10-85			6	40-10	LAGERFLANSCH	71309128	1	20-20			2	60-65
		1	10-90			2	40-15			2	20-25			2	60-70
		1	10-100	LAGER	1124697	1	10-40	LAGERINNENRING	700706039	2	10-45			4	60-85
KETTENRAD	47142	1	20-15	LAGER	50393	2	40-5	LAGERINNENRING	70341230	4	20-60			4	60-90
		4	20-20			2	40-10	LAGERINNENRING	70927347	2	10-90			4	60-95
		3	20-25			2	40-15	LAGERSATZ	700720153	1	10-30			2	70-60
KETTENRAD	Y747931	1	10-95	LAGER	51292	1	20-15			1	10-35			2	80-40
KLAUE	700137654P	8	60-5			2	20-25	LEITRAD	87726	1	20-25			4	80-45
KLAUE	700137655P	5	50-50			1	20-30							8	80-50
		5	50-55	LAGER	51318	1	10-15							8	80-55

1637308

LAGERVORSCHLAGSTEILE

D15

	Qty	PAGE		Qty	PAGE		Qty	PAGE		Qty	PAGE				
MASCH.SCHRB.KPL	6521868	1	10- 45	MUTTER	704247	2	30- 75	MUTTER	70916950	2	20- 25	NIPPEL	70915276	1	10- 40
		1	80- 30			2	40- 5			14	30- 5			1	40- 25
MASCH.SCHRB.UNC	354289X1	2	10- 25			6	40- 5			2	30- 5			1	40- 35
		1	80- 65			8	40- 5			20	30- 5			2	50- 5
		2	80- 70			16	40- 10			4	30- 5			1	50- 145
MESSER	700113188P	7	40- 65			16	40- 15			39	30- 10			1	50- 150
MESSER	700715627	1	50- 35			26	40- 45			4	30- 75			1	50- 155
		1	50- 120			4	40- 60			2	40- 5			1	50- 200
MESSER	700718710	1	50- 35			4	50- 5			4	40- 25			1	50- 205
		1	50- 120			18	50- 50			4	40- 35			1	50- 210
		1	50- 125			12	50- 55			1	40- 45			1	50- 215
MUTTER	700703458	24	50- 5			22	50- 60			5	40- 50			1	50- 220
		24	50- 10			6	50- 65			16	40- 65			1	50- 225
MUTTER	700710414	24	50- 5			2	50- 90			4	50- 25			3	50- 235
		24	50- 10			2	50- 165			6	50- 50			1	80- 85
		2	50- 40			2	50- 170			6	50- 55	NOCKEN	700113323P	1	50- 30
MUTTER	700715751	1	40- 15			5	60- 15			2	50- 85	O-RING	700706050	1	10- 45
						2	60- 20			5	50- 95	O-RING	700720106	1	50- 195
						2	60- 25			10	60- 5	O-RING	700724602	2	50- 195
						10	60- 35			26	60- 5	O-RING	7040330	1	10- 75
						10	60- 40			32	60- 5	O-RING	70921205	2	70- 5
						10	60- 45			2	60- 30			2	70- 15
						10	60- 50			6	60- 30			1	70- 60
						8	60- 55			2	60- 65	O-RING	70921206	1	70- 55
						2	60- 60			2	60- 70			1	70- 60
						2	60- 65			8	80- 50			1	70- 70
						6	60- 65			8	80- 55	O-RING	70921214	1	70- 70
						7	60- 70			4	80- 95	O-RING	70921349	3	70- 20
						8	60- 85	MUTTER	70917421	2	40- 65	O-RING	70921882	1	30- 30
						1	60- 90			1	50- 30	O-RING	70921885	1	70- 15
						2	60- 90			6	50- 50	O-RING	70923561	1	50- 35
						4	60- 90	MUTTER	7774995	1	10- 45	O-RING	831452M1	1	70- 5
						2	60- 95			10	80- 30	OELDICHTRING	700716382	2	10- 60
						4	60- 95	MUTTER	874404	6	50- 115	OELDICHTRING	700716383	2	10- 60
						11	60- 105	NABE	700112925	1	10- 95	OELDICHTRING	70248372	2	20- 60
						8	60- 110			1	10- 100	OELFILTER	7033616	1	70- 70
						10	60- 115	NABENTRIEB.	700720228	1	30- 5	PASSKEIL	700706643	1	10- 95
						6	60- 120			1	30- 10			1	10- 100
				MUTTER	704486	1	50- 30	NABENTRIEB.	700722199	1	30- 30	PATRONE	700706153	2	70- 20
						1	60- 30	NADEL	700122690	6	50- 5	PLATTE	6522866P	1	10- 40
										6	50- 10			1	10- 105
												PLATTE	6523807	1	50- 30
												PLATTE	700112903P	3	10- 40
														1	10- 105
												RADIALLAGER	700706124	4	40- 65
												REFLEKTOR	8722894	6	50- 115
												REPARATURSATZ	700150670	1	50- 125
												REPARATURSATZ	700154471	1	30- 95

LAGERVORSCHLAGSTEILE

D16

		Qty	PAGE			Qty	PAGE			Qty	PAGE			Qty	PAGE
REPARATURSATZ	700720122	1	10-20	SCHEIBE	700108820	4	10-40	SICHERUNGSMUTTER	700703922	1	10-10	SICHERUNGSMUTTER	Y704734	2	10-15
		1	10-30			2	10-105			1	20-25			4	20-10
REPARATURSATZ	7815053	2	10-20	SCHEIBE	700711025	2	20-30			2	20-55			23	20-15
		2	10-25	SCHEINWERFER	700721617	3	30-70			1	40-55			60	20-15
		2	10-30			4	30-75			9	50-10			3	20-20
		2	10-35	SCHELLE	7894975	2	20-45			1	50-105			90	20-20
		1	10-40			1	60-15			1	50-110			2	20-25
		2	80-65			1	60-20			1	80-45			9	20-25
		2	80-70			1	60-25			2	80-55			1	30-45
RIEGEL	700714528	2	20-45			4	60-35			2	80-60			4	30-45
		1	60-20			4	60-45	SICHERUNGSMUTTER	700711238	2	10-15			6	30-45
		1	60-25			8	60-55			2	10-100			2	30-50
		4	60-40			2	60-60			23	20-15			2	30-55
		4	60-50	SCHILD	6530471P	2	50-95			2	20-45			4	30-55
		6	60-60	SCHILD	700712446	1	10-20			6	30-15			6	30-55
RING	70927700	2	40-25			1	80-65			16	30-20			2	30-60
		2	40-35	SCHLAUCH	700706798	3	50-145			7	30-25			2	30-65
RING	738633	2	50-20			3	50-175			7	30-30			4	30-65
RING	7852148	2	40-25			3	50-180			5	30-35			6	30-65
		1	40-35			3	50-185			4	30-65			2	40-70
RITZEL	702700040	1	50-30	SCHNECKENRAD	7894413	1	50-30			2	40-10			4	40-70
ROLLE	6524623P	1	50-40	SCHRAUBE	7883374	1	30-45			2	40-15			4	50-10
ROLLE	6524870P	1	40-50			2	30-55			4	40-45			1	50-105
		1	50-95			2	30-65			4	40-55			1	50-110
ROLLE	6529945	6	50-20			3	60-70			2	50-15			16	50-175
		1	50-75			4	60-85			17	50-65			3	50-175
		1	50-120			4	60-90			17	50-70			19	50-180
ROLLE	700122799	1	50-35			4	60-95			1	50-105			16	50-185
ROLLE	700138225	1	50-100			4	60-105			2	50-105			6	50-185
SATZ	700122667	1	40-20	SCHRAUBE	8701781	2	50-85			5	50-105			7	50-190
SATZ	700122669	1	40-20			2	50-90			1	50-110			4	60-105
SATZ	700710805	1	50-235	SCHRAUBE	Y703132	4	40-5			2	50-110			9	60-135
SATZ	700710807	1	50-230			4	40-10			7	50-110			4	70-5
SATZ	700711425	1	10-35			4	40-15			1	60-20			1	70-10
SATZ	700720098	1	50-245			5	40-45			1	60-25			2	70-10
SATZ ANBAUTEILE	700114076	1	30-90	SCHRAUBE	Y706549	6	50-115			1	70-10			3	70-10
SATZ ANBAUTEILE	700114078	1	50-120	SCHRAUBENSATZ	700114059	1	80-30			2	70-10			2	70-15
SCHALTER	3901306M1	1	30-80	SEEGERING	700718131	2	50-10			1	70-55			4	70-70
SCHALTER	700113863	3	30-5	SICH.BLECH	6613624P	1	50-35			2	70-55			8	80-40
		1	30-10			1	30-120			12	70-60			3	80-85
		1	30-90			1	50-125			2	70-60				
SCHALTER	700119161	2	30-10	SICHERUNG	1695966M1	2	30-95			8	80-45				
		1	30-20			1	30-125	SICHERUNGSMUTTER	Y704635	6	50-55				
		1	30-25	SICHERUNG	3387318M1	2	30-95								
		1	30-95			1	30-125								
SCHALTER	700710208	1	30-25	SICHERUNG	700724610	1	50-195								
SCHALTER	700724612	1	50-195	SICHERUNGSHALTER	700724611	1	50-195								
SCHEIBE	1712868	1	50-30												

LAGERVORSCHLAGSTEILE

D18

		Qty	PAGE
ZINKE	700714199B	60	20-15
		60	20-20
ZUGFEDER	700712484	1	50-20
ZUGFEDER	758268	1	40-30
		1	50-40
ZUGFEDER	758441	1	50-95
		1	50-105
ZUGFEDER	758482	6	50-20
ZYLINDERSTIFT	863738	1	50-35

Qty PAGE

Qty PAGE

Qty PAGE

**PEZZI CHE RECCOMANDIANO DI TENERE A
MAGAZZINO**

D19

		Qty	PAGE			Qty	PAGE			Qty	PAGE			Qty	PAGE
AGO	700122690	6	50-5	ASTA	702400048	6	50-50	AUTOBLOCCANTE	Y704734	2	10-15	AUTOBLOCCANTE	Y704742	4	10-5
		6	50-10			6	50-60			4	20-10			4	10-10
ALBERO	6553267	1	50-30			6	50-65			23	20-15			4	10-15
ALBERO	6591580	1	50-35	AUTOBLOCCANTE	700703922	1	10-10			60	20-15			1	10-85
ALBERO	700138835P	5	20-20			1	20-25			3	20-20			7	10-90
ANELLO	70927700	2	40-25			2	20-55			90	20-20			1	20-15
		2	40-35			1	40-55			2	20-25			3	20-25
ANELLO	738633	2	50-20			9	50-10			9	20-25			16	20-35
ANELLO	7852148	2	40-25			1	50-105			1	30-45			4	20-45
		1	40-35			1	50-110			4	30-45			4	20-50
ANELLO RACCORD	700706045	1	10-45			1	80-45			6	30-45			8	20-55
		2	10-70			2	80-55			2	30-50			4	20-60
		2	10-80			2	80-60			2	30-55			12	40-20
ANELLO RACCORD	700706096	6	40-20	AUTOBLOCCANTE	700711238	2	10-15			4	30-55			1	40-55
ANELLO RACCORD	700716267	2	10-90			2	10-100			6	30-55			1	50-175
ANELLO RACCORD	700718774	1	70-65			23	20-15			2	30-60			1	50-180
ANELLO RACCORD	700723562	1	70-80			2	20-45			2	30-65			1	50-185
ANELLO RACCORD	8044695	12	50-50			6	30-15			4	30-65			10	80-30
		12	50-55			16	30-20			6	30-65			2	80-55
ANELLO SIEGER	355919X1	1	50-25			7	30-25			2	40-70	AZIONATORE	700709996	1	30-25
		1	50-40			7	30-30			4	40-70	AZIONATORE	700710211	2	30-10
ANELLO SIEGER	70927699	1	10-40			5	30-35			4	50-10			1	30-20
ANELLO SIEGER	70927728	1	50-35			4	30-65			1	50-105			2	30-25
ANELLO SIEGER	70927732	2	40-50			2	40-10			1	50-110			1	30-95
		1	50-30			2	40-15			16	50-175	BARRA	700113189	7	40-65
		2	50-95			4	40-45			3	50-175	BASE	700102136	1	50-35
		2	50-100			4	40-55			19	50-180	BEARING FLANGE	700108622P	10	20-15
ANELLO SIEGER	70927744	1	50-90			2	50-15			16	50-185	BEARING FLANGE	700109753P	1	10-95
ANELLO TENUTA	700706050	1	10-45			17	50-65			6	50-185			1	10-100
ANELLO TENUTA	700720106	1	50-195			17	50-70			7	50-190			4	40-10
ANELLO TENUTA	700724602	2	50-195			1	50-105			4	60-105			1	40-15
ANELLO TENUTA	7040330	1	10-75			2	50-105			9	60-135	BEARING FLANGE	700715941	1	50-80
ANELLO TENUTA	70921205	2	70-5			5	50-105			4	70-5	BEARING FLANGE	700716611	1	40-15
		2	70-15			1	50-110			1	70-10	BEARING FLANGE	71122510	2	20-55
		1	70-60			2	50-110			2	70-10	BEARING FLANGE	71309128	1	20-20
ANELLO TENUTA	70921206	1	70-55			7	50-110			3	70-10			2	20-25
		1	70-60			1	60-20			2	70-15	BOBINA	700706605	3	70-20
		1	70-70			1	60-25			4	70-70	BOBINA	700717218	3	70-25
ANELLO TENUTA	70921214	1	70-70			1	70-10			8	80-40	BOBINA	700725827	3	70-30
ANELLO TENUTA	70921349	3	70-20			2	70-10			3	80-85	BOCCOLA	52761	8	60-10
ANELLO TENUTA	70921882	1	30-30			1	70-55					BOCCOLA	6523500	7	50-25
ANELLO TENUTA	70921885	1	70-15			2	70-55							3	50-40
ANELLO TENUTA	70923561	1	50-35			12	70-60					BOCCOLA	6523799	1	30-20
ANELLO TENUTA	831452M1	1	70-5			2	70-60							10	50-20
ANNELLO ELASTICO	700718131	2	50-10			8	80-45					BOCCOLA	6565030	1	10-105
ARRESTO	700113036	2	10-40	AUTOBLOCCANTE	Y704635	6	50-55					BOCCOLA	700122681P	6	50-50
ASTA	6523740P	6	50-50											6	50-55
		6	50-55												
ASTA	700706503	6	50-115												

**PEZZI CHE RECCOMANDIANO DI TENERE A
MAGAZZINO**

D20

		Qty	PAGE			Qty	PAGE			Qty	PAGE			Qty	PAGE
BOCCOLA	700124038	12	40-5	BULLONE	70922786	2	10-15	CHIAVISTELLO	700714528	2	20-45	CUSCINETTO	711770	1	40-55
		12	40-10			2	10-100			1	60-20			1	50-5
		12	40-15			3	20-15			1	60-25			1	50-10
BOCCOLA	70936273	1	60-10			55	20-15			4	60-40	CUSCINETTO	712158	1	10-95
BOCCOLA	712810	1	40-25			40	20-20			4	60-50			1	10-100
		1	40-35			6	20-25			6	60-60			2	40-5
		2	50-5			6	40-5	CINGHIA TRAPEZO.	700718206	1	70-60			2	40-10
		2	50-10			8	40-10	CIRCUITO STAMP.	700724601	1	50-195			1	40-15
BOCCOLA	7849110	6	50-20			8	40-15	CLEAR.SIL.310ML	LC2312031	1	10-65	CUSCINETTO	7713829	2	40-65
		1	50-75			16	40-45			1	10-75	CUSCINETTO	7713837	1	40-25
		1	50-120			4	40-55	COLTELLO	700113188P	7	40-65			1	40-35
BOCCOLA	7852114	2	10-40			16	40-65	COLTELLO	700715627	1	50-35	CUSCINETTO	8050478	1	50-25
BOCCOLA	7852163	2	50-30			2	40-70			1	50-120	CUSCINETTO	8050866	2	50-20
BOCCOLA	7852593	2	50-35			6	50-50	COLTELLO	700718710	1	50-35	CUSCINETTO	Y710392	10	20-15
BOCCOLA	7852742	1	50-30			6	50-55			1	50-120	CUSCINETTO COMPL	700706124	4	40-65
BOCCOLA	8052177	1	10-95			4	50-65			1	50-125	CUSCINETTO SFERE	700722661	12	50-5
		1	10-100			4	50-70	CONO CUSCINETTO	700706039	2	10-45			12	50-10
BOCCOLA	Y52316	3	50-10			5	50-105	CONO CUSCINETTO	70341230	4	20-60			1	50-20
BOCCOLA PARAOLIO	700716382	2	10-60			7	50-110	CONO CUSCINETTO	70927347	2	10-90			6	50-20
BOCCOLA PARAOLIO	700716383	2	10-60			1	60-20	COPPA CUSCINETTO	700706038	2	10-45			1	50-80
BOCCOLA PARAOLIO	70248372	2	20-60			1	60-25	COPPA CUSCINETTO	70927348	2	10-90			1	50-120
BULBO	700722351	1	30-50			6	60-30	COPPA CUSCINETTO	832190M1	4	20-60			1	50-125
		1	30-55			2	60-65	COPPIA CONICA	7894389	1	50-30	CUSCINETTO SFERE	70575883	4	20-35
		1	30-60			2	60-70	CUSCINETTO	1109055	2	40-5			4	20-40
		1	30-65			4	60-85			6	40-10	DADO	700703458	24	50-5
BULBO 12V	3405180M1	1	30-80			4	60-90			2	40-15			24	50-10
BULBO 12V 21W	621235M1	4	30-40			4	60-95	CUSCINETTO	1124697	1	10-40	DADO	700710414	24	50-5
		1	30-45			2	70-60	CUSCINETTO	50393	2	40-5			24	50-10
		1	30-55			2	80-40			2	40-10			2	50-40
		1	30-65			4	80-45			2	40-15	DADO	700715751	1	40-15
BULBO 21/5W	908543M1	1	30-45			8	80-50	CUSCINETTO	51292	1	20-15				
		1	30-55			8	80-55			2	20-25				
		1	30-65	BULLONE COMPLET	6521868	1	10-45			1	20-30				
BULLONE	700710413	24	50-5			1	80-30	CUSCINETTO	51318	1	10-15				
		24	50-10	BULLONE UNC	354289X1	2	10-25	CUSCINETTO	6105159	3	40-55				
						1	80-65	CUSCINETTO	6849160	4	50-5				
						2	80-70			4	50-10				
				CAMMA	700113323P	1	50-30	CUSCINETTO	700110467P	1	10-15				
				CANE	700137654P	8	60-5	CUSCINETTO	700112892	2	40-25				
				CANE	700137655P	5	50-50			2	40-35				
						5	50-55	CUSCINETTO	700704263	1	40-15				
				CAPUCHON	26260	2	20-60	CUSCINETTO	700705612	5	20-15				
				CARTUCCIA	700706153	2	70-20	CUSCINETTO	700706131	6	40-20				
				CATENA	7087935	1	10-95	CUSCINETTO	700706956	1	10-40				
				CHIAVETTA	700706643	1	10-95	CUSCINETTO	700720050	5	20-15				
						1	10-100			10	20-20				
								CUSCINETTO	700723350	2	40-60				
								CUSCINETTO	70590709	15	20-20				

**PEZZI CHE RECCOMANDIANO DI TENERE A
MAGAZZINO**

D21

Qty	PAGE	Qty	PAGE	Qty	PAGE	Qty	PAGE								
DADO	704247	2	30-75	DADO	70916950	2	20-25	FARO	700716461	2	30-45	INGRASSATORE	70923219	1	10-5
		2	40-5			14	30-5			2	30-55			1	10-10
		6	40-5			2	30-5			2	30-65			1	10-45
		8	40-5			20	30-5	FARO	700726172	1	30-50			2	10-55
		16	40-10			4	30-5			3	30-55			2	10-60
		16	40-15			39	30-10			1	30-60			2	20-50
		26	40-45			4	30-75			3	30-65			2	20-55
		4	40-60			2	40-5			2	30-75			1	40-25
		4	50-5			4	40-25	FASCETTA CAVI	70925442	8	80-80			1	40-30
		18	50-50			4	40-35	FELTRO	844498	2	70-70			8	50-15
		12	50-55			1	40-45	FERMAGLIO	7894975	2	20-45			1	50-30
		22	50-60			5	40-50			1	60-15			1	50-100
		6	50-65			16	40-65			1	60-20			2	60-10
		2	50-90			4	50-25			1	60-25			4	60-10
		2	50-165			6	50-50			4	60-35			2	80-50
		2	50-170			6	50-55			4	60-45			2	80-55
		5	60-15			2	50-85			8	60-55			1	80-60
		2	60-20			5	50-95			2	60-60			2	50-40
		2	60-25			10	60-5	FILTRO	7825516	1	70-70	INSIEME VITI	70923306	2	50-40
		10	60-35			26	60-5	FILTRO	8799280	1	10-65	INTERRUTTORE	3901306M1	1	30-80
		10	60-40			32	60-5			1	10-75	INTERRUTTORE	700113863	3	30-5
		10	60-45			2	60-30			2	70-45			1	30-10
		10	60-50			6	60-30	FILTRO OLIO	7033616	1	70-70	INTERRUTTORE	700119161	2	30-10
		8	60-55			2	60-65	FLANGIA	051417P	2	20-15			1	30-20
		2	60-60			2	60-70			2	20-20			1	30-25
		2	60-65			8	80-50			5	20-25			1	30-95
		6	60-65			8	80-55			1	20-30	INTERRUTTORE	700710208	1	30-25
		7	60-70			4	80-95	FLANGIA	6105621P	3	40-55	INTERRUTTORE	700724612	1	50-195
		8	60-85	DADO	70917421	2	40-65	FLANGIA	700711918	4	20-55	KIT	700122667	1	40-20
		1	60-90			1	50-30	FLANGIA	714360	2	10-95	KIT	700122669	1	40-20
		2	60-90			6	50-50			4	40-5	KIT	700710805	1	50-235
		4	60-90	DADO	7774995	1	10-45			2	50-25	KIT	700710807	1	50-230
		2	60-95			10	80-30	FLANGIA	Y710293	30	20-20	KIT	700711425	1	10-35
		4	60-95	DADO	874404	6	50-115	GANCIO	1712835	1	50-35	KIT	700720098	1	50-245
		11	60-105	DENTE ELASTICO	700714199B	60	20-15	GIUNTO UNIVERSAL	700712443	1	10-20	KIT ACCESSORI	700114076	1	30-90
		8	60-110			60	20-20			1	80-65	KIT ACCESSORI	700114078	1	50-120
		10	60-115	DISCO	1712868	1	50-30	GOMITO	700706682	9	50-175	KIT BULLONE	700114059	1	80-30
		6	60-120	DISCO	700108820	4	10-40			10	50-235	KIT CUSCINETTO	700720153	1	10-30
DADO	704486	1	50-30			2	10-105			2	50-240			1	10-35
		1	60-30	DISCO	700711025	2	20-30			11	50-245	KIT GIUNTO	7732274	1	70-35
				DISCO FRENO	700112875P	1	40-40	GUIDA	700139255	1	50-90	KIT GIUNTO	7738800	1	70-80
				DISCO FRIZIONE	700710946	2	40-40	IMBALLATORE	700113244P	25	20-10	KIT RIPARAZIONE	700150670	1	50-125
						2	50-45	INGRANAGGIO	7894454	1	50-30	KIT RIPARAZIONE	700154471	1	30-95
				DISTANZIALE	2401516P	1	50-110	INGRANAGGIO	8802795	2	50-85	KIT RIPARAZIONE	700720122	1	10-20
				DISTANZIALE	6530828P	2	50-85			2	50-90			1	10-30
				DISTANZIALE	700137750P	5	20-15	INGRANAGGIO ELIC	7894413	1	50-30				
						10	20-20								
				DITO	700113345P	6	50-50								
						6	50-55								

**PEZZI CHE RECCOMANDIANO DI TENERE A
MAGAZZINO**

D22

			Qty	PAGE				Qty	PAGE				Qty	PAGE				Qty	PAGE		
KIT RIPARAZIONE	7815053	2	10-20	MANICOTTO	7849656	6	50-20	MOLLA TENDITRICE	758441	1	50-95	PROFILATO	700138830P	10	20-20						
		2	10-25			1	50-75			1	50-105	RACCORDO	70919171	3	50-180						
		2	10-30			1	50-120	MOLLA TENDITRICE	758482	6	50-20			3	80-85						
		2	10-35	MANICOTTO	7852718	1	10-45	MORSETTO	700706683	6	50-175	RICEVITORE	700714529	2	20-45						
		1	10-40	MANIGLIA	7894967	2	20-45			6	50-235			1	60-20						
		2	80-65			1	60-15			2	50-240			1	60-25						
		2	80-70			1	60-20			6	50-245			4	60-40						
KIT TENUTA	700708625	1	70-50			1	60-25	MOZZO	700112925	1	10-95			4	60-50						
KIT TENUTA	700710949	1	70-65			4	60-35			1	10-100			6	60-60						
KIT TENUTA	700711954	1	70-40			4	60-45	NIPPLO	70915276	1	10-40	RIPARO	6530471P	2	50-95						
KIT TENUTA	700715662	5	70-20			8	60-55			1	40-25	RIPARO	700712446	1	10-20						
KIT TENUTA	700715929	4	70-25			2	60-60			1	40-35			1	80-65						
		5	70-30	MANOVELLA	700113239	5	20-15			2	50-5	RONDELLA	6591572	1	50-35						
KIT TENUTA	700722237	1	70-65	MANOVELLA	700138828P	5	20-20			1	50-145	RONDELLA	705541	4	10-5						
KIT TENUTA	700723560	1	70-80	MANOVELLA	700138829P	5	20-20			1	50-150			4	10-10						
LACCIO	866566	12	50-5	MOLLA	58107B	8	10-105			1	50-155			4	10-15						
		12	50-10			8	20-30			1	50-200			1	10-85						
		6	50-20	MOLLA	58644	10	50-45			1	50-205			1	10-90						
		1	50-120			1	50-105			1	50-210			1	20-20						
		1	50-125			1	50-110			1	50-215			1	20-25						
LAMPADINA	700721617	3	30-70			1	60-90			1	50-220			4	20-45						
		4	30-75	MOLLA	58941	1	60-75			1	50-225			4	20-60						
LEGATORE	700700968	1	50-30			1	60-80			3	50-235			8	20-60						
		1	50-35	MOLLA	6522700P	2	20-50			1	80-85			1	40-50						
		1	50-120			2	20-55	OJO DE GATO	8722894	6	50-115			10	40-65						
		1	50-125	MOLLA	6553259P	2	50-30	PARAURTI	827568	1	40-55			4	40-65						
LENTE	71193862	4	30-40	MOLLA	700714166	1	50-100	PERNO	700113037	2	10-40			24	50-5						
MAGLIA	329264M91	1	20-15	MOLLA	758011	10	40-40	PERNO	70922135	1	50-30			24	50-10						
		1	20-20	MOLLA	7758212	2	20-45	PERNO	70922598	3	50-30			2	50-15						
		1	20-25			1	60-15			1	50-120			4	50-20						
MAGLIA	329277M91	1	20-25			1	60-20			1	50-125			4	50-25						
MAGLIA	700124036P	3	40-5			1	60-25	PERNO	863753	1	20-50			2	50-95						
		3	40-10			4	60-35			1	20-55			4	50-105						
		3	40-15			4	60-45	PERNO D'ATTACCO	700706685	5	50-50			4	50-110						
MAGLIA	7088008	1	10-95			8	60-55			5	50-55			2	80-45						
MAGLIA	86405	1	10-85			2	60-60			8	60-5										
		1	10-90	MOLLA	7758758	1	40-25			1	10-40	PIASTRA	6522866P	1	10-40						
		1	10-100			1	40-35			1	10-105										
MAGLIA INCLINATA	329266M91	1	20-15	MOLLA	858308	2	20-35			1	50-30	PIASTRA	6523807	1	50-30						
		1	20-20			1	40-50			3	10-40	PIASTRA	700112903P	3	10-40						
		1	20-25			2	50-20			1	10-105										
MAGLIA INCLINATA	329420M91	1	20-25	MOLLA COMPOSTA	58511	4	20-30			1	50-35	PIASTRA DI FERMO	6613624P	1	50-35						
MAGLIA INCLINATA	329421M91	1	10-95	MOLLA COMPOSTA	858019	8	10-40			1	50-120			1	50-120						
		1	10-100	MOLLA COMPOSTA	858027	2	50-85			1	50-125			1	50-125						
		3	30-5			2	50-90	PIGNONE	702700040	1	50-30			1	50-30						
MAGNETE	700706340	1	30-10	MOLLA TENDITRICE	700712484	1	50-20	PORTA FUSIBILI	700724611	1	50-195			1	50-195						
		1	30-90	MOLLA TENDITRICE	758268	1	40-30	PRESAELETTRICI M	3760032M1	1	30-100			1	30-100						
MANICOTTO	6526081	1	10-85			1	50-40	PRIGIONIERO	6523229	1	50-30			1	50-30						
		1	10-90					PROFILATO	700113235	5	20-15										

RECAMBIO QUE SE RECOMIENDA MANTENER EN STOCK

D24

		Qty	PAGE			Qty	PAGE			Qty	PAGE			Qty	PAGE
ACCIONAMIENTO	700709996	1	30- 25	ARANDELA	705541	4	10- 5	ARANDELA	Y705525	23	20- 40	ARANDELA	Y705533	4	10- 15
ACCIONAMIENTO	700710211	2	30- 10			4	10- 10			2	20- 45			8	20- 10
		1	30- 20			4	10- 15			6	20- 45			60	20- 15
		2	30- 25			1	10- 85			4	30- 15			60	20- 20
		1	30- 95			1	10- 90			1	30- 20			2	20- 25
AGUJA	700122690	6	50- 5			1	20- 20			2	30- 30			5	20- 40
		6	50- 10			1	20- 25			2	30- 35			3	30- 15
ANILLA RETENCION	355919X1	1	50- 25			4	20- 45			2	30- 40			3	30- 20
		1	50- 40			4	20- 60			2	50- 195			1	30- 25
ANILLA RETENCION	70927699	1	10- 40			8	20- 60			6	60- 15			X	30- 40
ANILLA RETENCION	70927728	1	50- 35			1	40- 50			1	60- 20			3	30- 70
ANILLA RETENCION	70927732	2	40- 50			10	40- 65			2	60- 20			2	30- 75
		1	50- 30			4	40- 65			5	60- 20			4	30- 75
		2	50- 95			24	50- 5			1	60- 25			2	40- 5
		2	50- 100			24	50- 10			2	60- 25			2	40- 10
ANILLA RETENCION	70927744	1	50- 90			2	50- 15			5	60- 25			2	40- 15
ANILLO COJINETE	700706038	2	10- 45			4	50- 20			6	60- 25			4	40- 45
ANILLO COJINETE	70927348	2	10- 90			4	50- 25			2	60- 30			4	40- 50
ANILLO COJINETE	832190M1	4	20- 60			2	50- 95			10	60- 35			15	40- 65
ANILLO FORMA 'O'	700706050	1	10- 45			4	50- 105			6	60- 40			16	40- 65
ANILLO FORMA 'O'	700720106	1	50- 195			4	50- 110			10	60- 45			2	50- 15
ANILLO FORMA 'O'	700724602	2	50- 195			2	80- 45			6	60- 50			4	50- 25
ANILLO FORMA 'O'	7040330	1	10- 75							4	60- 60			2	50- 95
ANILLO FORMA 'O'	70921205	2	70- 5							20	60- 65			2	50- 105
		2	70- 15							2	60- 90			5	50- 105
		1	70- 60							5	70- 5			2	50- 110
ANILLO FORMA 'O'	70921206	1	70- 55							4	70- 10			7	50- 110
		1	70- 60							10	70- 15			26	60- 5
		1	70- 70							3	70- 45			2	60- 25
ANILLO FORMA 'O'	70921214	1	70- 70							2	70- 55			2	60- 30
ANILLO FORMA 'O'	70921349	3	70- 20							3	70- 55			6	60- 30
ANILLO FORMA 'O'	70921882	1	30- 30											2	60- 65
ANILLO FORMA 'O'	70921885	1	70- 15											2	60- 70
ANILLO FORMA 'O'	70923561	1	50- 35											1	70- 10
ANILLO FORMA 'O'	831452M1	1	70- 5											2	70- 10
ANUDADOR	700700968	1	50- 30											2	70- 60
		1	50- 35											6	80- 45
		1	50- 120											1	50- 30
		1	50- 125											1	50- 35
APRIETACABLES	70925442	8	80- 80											5	20- 20
ARANDELA	6591572	1	50- 35											1	10- 45
														2	10- 70
														2	10- 80
														6	40- 20
														2	10- 90
														1	70- 65
														1	70- 80
														12	50- 50
														12	50- 55

RECAMBIO QUE SE RECOMIENDA MANTENER EN STOCK

D25

	Qty	PAGE			Qty	PAGE			Qty	PAGE			Qty	PAGE	
ARO	70927700	2	40-25	BOMB C/I 21/5W	908543M1	1	30-45	CASQUILLO	Y52316	3	50-10	COJINETE	700112892	2	40-25
		2	40-35			1	30-55	CATADIOPTRICO	8722894	6	50-115			2	40-35
ARO	738633	2	50-20			1	30-65	CENTRAJE	863738	1	50-35	COJINETE	700704263	1	40-15
ARO	7852148	2	40-25	BOMBILLA	700722351	1	30-50	CERROJO	700714528	2	20-45	COJINETE	700705612	5	20-15
		1	40-35			1	30-55			1	60-20	COJINETE	700706131	6	40-20
BARRA	700113189	7	40-65			1	30-60			1	60-25	COJINETE	700706956	1	10-40
BARRA DE ENLACE	70925094	4	30-5			1	30-65			4	60-40	COJINETE	700720050	5	20-15
		4	30-10	BOMBILLA 12V	3405180M1	1	30-80			4	60-50			10	20-20
		1	30-15	BUJE RETENACEITE	700716382	2	10-60			6	60-60	COJINETE	700723350	2	40-60
		1	30-20	BUJE RETENACEITE	700716383	2	10-60	CHAVETA ROSCADO	6523229	1	50-30	COJINETE	70590709	15	20-20
		5	30-25	BUJE RETENACEITE	70248372	2	20-60	CIERRE	866566	12	50-5	COJINETE	711770	1	40-55
		2	30-35	BULON CILINDRICO	700706685	5	50-50			12	50-10			1	50-5
		1	30-40			5	50-55			6	50-20			1	50-10
		1	30-50			8	60-5			1	50-120	COJINETE	712158	1	10-95
		8	30-55	CADENA	7087935	1	10-95			1	50-125			1	10-100
		1	30-60	CADENA 5M	W980268US	1	10-85	CIRCUITO IMPRESO	700724601	1	50-195			2	40-5
		8	30-65			1	10-90	CJT PERNO	6521868	1	10-45			2	40-10
		X	30-70			1	10-100			1	80-30			1	40-15
		18	30-75	CAJA	700114079	1	50-240	CLAVE	700706643	1	10-95	COJINETE	7713829	2	40-65
		2	30-85	CALCE	6522932	2	10-40			1	10-100	COJINETE	7713837	1	40-25
		36	50-135	CALCE	6553275	2	50-30	CLEAR.SIL.310ML	LC2312031	1	10-65			1	40-35
		18	50-140			9	50-45			1	10-75	COJINETE	8050478	1	50-25
		5	50-160	CANAL	700113235	5	20-15	CLIP	7894975	2	20-45	COJINETE	8050866	2	50-20
		3	50-180	CANAL	700138830P	10	20-20			1	60-15	COJINETE	Y710392	10	20-15
		1	50-190	CASQUILLO	52761	8	60-10			1	60-20	COJINETE DE BOLA	700722661	12	50-5
		12	60-135	CASQUILLO	6523500	7	50-25			1	60-25			12	50-10
		4	80-85			3	50-40			4	60-35			1	50-20
BASE	700102136	1	50-35	CASQUILLO	6523799	1	30-20			4	60-45			6	50-20
BEARING FLANGE	700108622P	10	20-15			10	50-20			8	60-55			1	50-80
BEARING FLANGE	700109753P	1	10-95	CASQUILLO	6565030	1	10-105			2	60-60			1	50-120
		1	10-100	CASQUILLO	700122681P	6	50-50	CODO	700706682	9	50-175			1	50-125
		4	40-10			6	50-55			10	50-235	COJINETE DE BOLA	70575883	4	20-35
		1	40-15	CASQUILLO	700124038	12	40-5			2	50-240			4	20-40
BEARING FLANGE	700715941	1	50-80			12	40-10			11	50-245	CONECTOR	700706683	6	50-175
BEARING FLANGE	700716611	1	40-15			12	40-15	COJINETE	1109055	2	40-5			6	50-235
BEARING FLANGE	71122510	2	20-55	CASQUILLO	70936273	1	60-10			6	40-10			2	50-240
BEARING FLANGE	71309128	1	20-20	CASQUILLO	712810	1	40-25			2	40-15			6	50-245
		2	20-25			1	40-35	COJINETE	1124697	1	10-40	CONO COJINETE	700706039	2	10-45
BLINDAJE	6530471P	2	50-95			2	50-5	COJINETE	50393	2	40-5	CONO COJINETE	70341230	4	20-60
BLINDAJE	700712446	1	10-20			2	50-10			2	40-10	CONO COJINETE	70927347	2	10-90
		1	80-65	CASQUILLO	7849110	6	50-20			2	40-15				
BOBINA	700706605	3	70-20			1	50-75	COJINETE	51292	1	20-15				
BOBINA	700717218	3	70-25			1	50-120			2	20-25				
BOBINA	700725827	3	70-30	CASQUILLO	7852114	2	10-40			1	20-30				
BOMB 12V 21W SBC	621235M1	4	30-40	CASQUILLO	7852163	2	50-30	COJINETE	51318	1	10-15				
		1	30-45	CASQUILLO	7852593	2	50-35	COJINETE	6105159	3	40-55				
		1	30-55	CASQUILLO	7852742	1	50-30	COJINETE	6849160	4	50-5				
		1	30-65	CASQUILLO	8052177	1	10-95			4	50-10				
						1	10-100	COJINETE	700110467P	1	10-15				

RECAMBIO QUE SE RECOMIENDA MANTENER EN STOCK

D26

Qty	PAGE	Qty	PAGE	Qty	PAGE	Qty	PAGE
CONTRATUERCA 700703922	1 10-10 1 20-25 2 20-55 1 40-55 9 50-10 1 50-105 1 50-110 1 80-45 2 80-55 2 80-60	CONTRATUERCA Y704734	2 10-15 4 20-10 23 20-15 60 20-15 3 20-20 90 20-20 2 20-25 9 20-25 1 30-45 4 30-45 6 30-45 2 30-50 2 30-55 4 30-55 6 30-55 2 30-60 2 30-65 4 30-65 6 30-65 2 40-70 4 40-70 4 50-10 1 50-105 1 50-110 16 50-175 3 50-175 19 50-180 16 50-185 6 50-185 7 50-190 4 60-105 9 60-135 4 70-5 1 70-10 2 70-10 3 70-10 2 70-15 4 70-70 8 80-40 3 80-85	CONTRATUERCA Y704742	4 10-5 4 10-10 4 10-15 1 10-85 7 10-90 1 20-15 3 20-25 16 20-35 4 20-45 4 20-50 8 20-55 4 20-60 12 40-20 1 40-55 1 50-175 1 50-180 1 50-185 10 80-30 2 80-55 1 70-60 1 10-95 1 10-100 7 40-65 1 50-35 1 50-120 1 50-35 1 50-120 1 50-125 6 50-50 6 50-55 1 50-195 1 50-30 4 30-5 4 30-10 5 30-30 1 30-90 1 30-95 1 10-75 60 20-15 60 20-20 1 50-30 4 10-40 2 10-105 2 20-30 2 40-40 2 50-45 1 40-40 1 50-110 2 50-85	DISCO ESPACIADOR 700137750P	5 20-15 10 20-20 2 70-20 1 50-30 2 50-85 2 50-90 1 50-30 1 50-30 1 10-5 1 10-10 1 10-45 2 10-55 2 10-60 2 20-50 2 20-55 1 40-25 1 40-30 8 50-15 1 50-30 1 50-100 2 60-10 4 60-10 2 80-50 2 80-55 1 80-60 1 20-15 1 20-20 1 20-25 1 20-25 3 40-5 3 40-10 3 40-15 1 10-95 1 10-85 1 10-90 1 10-100 25 20-10 24 50-5 24 50-10
CONTRATUERCA 700711238	2 10-15 2 10-100 23 20-15 2 20-45 6 30-15 16 30-20 7 30-25 7 30-30 5 30-35 4 30-65 2 40-10 2 40-15 4 40-45 4 40-55 2 50-15 17 50-65 17 50-70 1 50-105 2 50-105 5 50-105 1 50-110 2 50-110 7 50-110 1 60-20 1 60-25 1 70-10 2 70-10 1 70-55 2 70-55 12 70-60 2 70-60 8 80-45 6 50-55			CORREA EN V 700718206 CUBO 700112925 CUCHILLA 700113188P CUCHILLA 700715627 CUCHILLA 700718710 DEDO 700113345P DEPOSITO HIDRAU 700724605 DESBARBADOR 700138858 DETECTOR 700706398 DETECTOR 71393718 DIENTE 700714199B DISCO 1712868 DISCO 700108820 DISCO 700711025 DISCO DE EMBRAGU 700710946 DISCO DE FRENO 700112875P DISCO ESPACIADOR 2401516P DISCO ESPACIADOR 6530828P	ENLACE 329264M91 ENLACE 329277M91 ENLACE 700124036P ENLACE 7088008 ENLACE 86405 ENVASE 700113244P ESPIGA/BULON 700710413		

RECAMBIO QUE SE RECOMIENDA MANTENER EN STOCK

D27

		Qty	PAGE			Qty	PAGE			Qty	PAGE			Qty	PAGE
ESPIGA/BULON	70922786	2	10-15	FUSIBLE	700724610	1	50-195	LAMPARA/LUZ	700726172	1	30-50	PASADOR	70922598	3	50-30
		2	10-100	GANCHO	1712835	1	50-35			3	30-55			1	50-120
		3	20-15	GRAPA CIRCULAR	700718131	2	50-10			1	30-60			1	50-125
		55	20-15	GUIA	700139255	1	50-90			3	30-65	PASADOR	863753	1	20-50
		40	20-20	IMAN	700706340	3	30-5			2	30-75			1	20-55
		6	20-25			1	30-10	LENTE DE VIDRIO	71193862	4	30-40	PERNO UNC	354289X1	2	10-25
		6	40-5			1	30-90	LEVA	700113323P	1	50-30			1	80-65
		8	40-10	INTERRUPTOR	3901306M1	1	30-80	MANCHA	6526081	1	10-85			2	80-70
		8	40-15	INTERRUPTOR	700113863	3	30-5			1	10-90	PINON	702700040	1	50-30
		16	40-45			1	30-10	MANCHA	7849656	6	50-20	PLACA DE BLOCAJE	6613624P	1	50-35
		4	40-55			1	30-90			1	50-75			1	50-120
		16	40-65	INTERRUPTOR	700119161	2	30-10			1	50-120			1	50-125
		2	40-70			1	30-20	MANCHA	7852718	1	10-45	PLATO	6522866P	1	10-40
		6	50-50			1	30-25	MANETA	7894967	2	20-45			1	10-105
		6	50-55			1	30-95			1	60-15	PLATO	6523807	1	50-30
		4	50-65	INTERRUPTOR	700710208	1	30-25			1	60-20	PLATO	700112903P	3	10-40
		4	50-70	INTERRUPTOR	700724612	1	50-195			1	60-25			1	10-105
		5	50-105	JUEGO	700122667	1	40-20			4	60-35	PLETINA	051417P	2	20-15
		7	50-110	JUEGO	700122669	1	40-20			4	60-45			2	20-20
		1	60-20	JUEGO	700710805	1	50-235			8	60-55			5	20-25
		1	60-25	JUEGO	700710807	1	50-230			2	60-60			1	20-30
		6	60-30	JUEGO	700711425	1	10-35	MANIVELA	700113239	5	20-15	PLETINA	6105621P	3	40-55
		2	60-65	JUEGO	700720098	1	50-245	MANIVELA	700138828P	5	20-20	PLETINA	700711918	4	20-55
		2	60-70	JUEGO ACCESORIO	700114076	1	30-90	MANIVELA	700138829P	5	20-20	PLETINA	714360	2	10-95
		4	60-85	JUEGO ACCESORIO	700114078	1	50-120	MUELLE TENSION	700712484	1	50-20			4	40-5
		4	60-90	JUEGO COJINETES	700720153	1	10-30	MUELLE TENSION	758268	1	40-30			2	50-25
		4	60-95			1	10-35			1	50-40	PLETINA	Y710293	30	20-20
		2	70-60	JUEGO JUNTAS	7732274	1	70-35	MUELLE TENSION	758441	1	50-95	POLEA LOCA	87726	1	20-25
		2	80-40	JUEGO JUNTAS	7738800	1	70-80			1	50-105	PORTAFUSIBLE	700724611	1	50-195
		4	80-45	JUEGO REPARACION	700150670	1	50-125	MUELLE TENSION	758482	6	50-20	PRISIONERO	700137654P	8	60-5
		8	80-50	JUEGO REPARACION	700154471	1	30-95	NIPLE	70915276	1	10-40	PRISIONERO	700137655P	5	50-50
		8	80-55	JUEGO REPARACION	700720122	1	10-20			1	40-25			5	50-55
FARO	700721617	3	30-70			1	10-30			1	40-35	RACOR	70919171	3	50-180
		4	30-75	JUEGO REPARACION	7815053	2	10-20			2	50-5			3	80-85
FIADOR TRINQUETE	700113036	2	10-40			2	10-25			1	50-145	RECEPTOR	700714529	2	20-45
FIELTRO	844498	2	70-70			2	10-30			1	50-150			1	60-20
FILTRO	7825516	1	70-70			2	10-35			1	50-155			1	60-25
FILTRO	8799280	1	10-65			1	10-40			1	50-200			4	60-40
		1	10-75			2	80-65			1	50-205			4	60-50
		2	70-45			2	80-70			1	50-210			6	60-60
FILTRO DE ACEITE	7033616	1	70-70	JUNTA UNIVERSAL	700712443	1	10-20			1	50-215	RESORTE	58107B	8	10-105
FLEXIBLE	700706798	3	50-145			1	80-65			1	50-220			8	20-30
		3	50-175	LAMPARA/LUZ	700716461	2	30-45			1	50-225	RESORTE	58644	10	50-45
		3	50-180			2	30-55			3	50-235			1	50-105
		3	50-185			2	30-65			1	80-85			1	50-110
FUSIBLE	1695966M1	2	30-95					PARAGOLPES	827568	1	40-55			1	60-90
		1	30-125					PASADOR	700113037	2	10-40	RESORTE	58941	1	60-75
FUSIBLE	3387318M1	2	30-95					PASADOR	70922135	1	50-30			1	60-80
		1	30-125												

1637308

RECAMBIO QUE SE RECOMIENDA MANTENER EN STOCK

D28

		Qty	PAGE			Qty	PAGE			Qty	PAGE			Qty	PAGE
RESORTE	6522700P	2	20-50	TOMACORRIENTE M	3760032M1	1	30-100	TUERCA	704247	2	30-75	TUERCA	70916950	2	20-25
		2	20-55	TORNILLO	7883374	1	30-45			2	40-5			14	30-5
RESORTE	6553259P	2	50-30			2	30-55			6	40-5			2	30-5
RESORTE	700714166	1	50-100			2	30-65			8	40-5			20	30-5
RESORTE	758011	10	40-40			3	60-70			16	40-10			4	30-5
RESORTE	7758212	2	20-45			4	60-85			16	40-15			39	30-10
		1	60-15			4	60-90			26	40-45			4	30-75
		1	60-20			4	60-95			4	40-60			2	40-5
		1	60-25			4	60-105			4	50-5			4	40-25
		4	60-35	TORNILLO	8701781	2	50-85			18	50-50			4	40-35
		4	60-45			2	50-90			12	50-55			1	40-45
		8	60-55	TORNILLO	Y703132	4	40-5			22	50-60			5	40-50
		2	60-60			4	40-10			6	50-65			16	40-65
RESORTE	7758758	1	40-25			4	40-15			2	50-90			4	50-25
		1	40-35			5	40-45			2	50-165			6	50-50
RESORTE	858308	2	20-35	TORNILLO	Y706549	6	50-115			2	50-170			6	50-55
		1	40-50	TORNILLO TAPON	700707998	8	10-40			5	60-15			2	50-85
		2	50-20	TORNILLO TAPON	70923114	1	50-175			2	60-20			5	50-95
RESORTE DE COMP.	58511	4	20-30			1	50-180			2	60-25			10	60-5
RESORTE DE COMP.	858019	8	10-40			1	50-185			10	60-35			26	60-5
RESORTE DE COMP.	858027	2	50-85			2	60-30			10	60-40			32	60-5
		2	50-90	TORNILLO TAPON	70923161	1	10-15			10	60-45			2	60-30
RETENES JUEGO	700708625	1	70-50	TORNILLO TAPON	70924666	1	10-85			10	60-50			6	60-30
RETENES JUEGO	700710949	1	70-65			1	10-90			8	60-55			2	60-65
RETENES JUEGO	700711954	1	70-40			10	80-30			2	60-60			2	60-70
RETENES JUEGO	700715662	5	70-20	TORNILLO TAPON	70934842	16	60-5			2	60-65			8	80-50
RETENES JUEGO	700715929	4	70-25	TORNILLO TAPON	8701476	12	50-5			6	60-65			8	80-55
		5	70-30			12	50-10			7	60-70			4	80-95
RETENES JUEGO	700722237	1	70-65			6	50-20			8	60-85	TUERCA	70917421	2	40-65
RETENES JUEGO	700723560	1	70-80			1	50-120			1	60-90			1	50-30
RODAMIENTO RAD	700706124	4	40-65			1	50-125			2	60-90			6	50-50
RODILLO	6524623P	1	50-40	TORNILLOS JUEGO	700114059	1	80-30			4	60-90	TUERCA	7774995	1	10-45
RODILLO	6524870P	1	40-50	TRANSDUCER	700720228	1	30-5			2	60-95			10	80-30
		1	50-95			1	30-10			4	60-95	TUERCA	874404	6	50-115
RODILLO	6529945	6	50-20	TRANSDUCER	700722199	1	30-30			11	60-105	UNION ACODADA	329266M91	1	20-15
		1	50-75	TUERCA	700703458	24	50-5			8	60-110			1	20-20
		1	50-120			24	50-10			10	60-115			1	20-25
RODILLO	700122799	1	50-35	TUERCA	700710414	24	50-5			6	60-120	UNION ACODADA	329420M91	1	20-25
RODILLO	700138225	1	50-100			24	50-10	TUERCA	704486	1	50-30	UNION ACODADA	329421M91	1	10-95
RUEDA DE CADENA	47142	1	20-15			2	50-40			1	60-30			1	10-100
		4	20-20	TUERCA	700715751	1	40-15					VALVULA SOLENOID	1079721M1	2	70-25
		3	20-25											2	70-30
RUEDA DE CADENA	Y747931	1	10-95									VARILLA	6523740P	6	50-50
SET SCREW	70923306	2	50-40											6	50-55
SOLENOIDE	700710176	3	70-20									VARILLA	700706503	6	50-115
SUJETADOR	8045148	1	50-30									VARILLA	702400048	6	50-50
TAPA	26260	2	20-60											6	50-60
TENSOR	7895733	1	50-30											6	50-65
TERMOSTATO	700716952	1	10-75												

1637308

--	--	--

RESERVED

**NUMERICAL INDEX
INDEX NUMERIQUE
NUMMERN-INDEX
INDICE NUMERICO
INDICE NUMERICO**

G 1

050575P	20-35	1703354	50-20	3405180M1	30-80	353898X1	70-5	364352X1	30-40	3901320M91	60-145
	20-40		50-80	353433X1	50-5	354057X1	50-50	364423X1	10-95	3901322M91	60-100
051417P	20-15		50-125		60-155		60-35		10-100	3901323M91	60-55
	20-20		50-135	353434X1	30-40		60-45	364533X1	70-5	3901324M91	60-100
	20-25		50-140		30-70	354059X1	60-140	364534X1	60-35	3901333M1	60-150
	20-30	1712835	50-35		70-5	354070X1	70-5		60-45	3901340M1	60-150
1003115M1	20-50	1712868	50-30	353436X1	30-5	354076X1	40-50		60-55	3901358M1	60-150
	20-55	1713486	70-80		30-10	354089X1	60-10	364941X1	60-75	3901359M1	60-150
1045127M1	70-50	1713973	30-110		30-30	354120X1	20-45		60-80	3901360M1	60-150
1079721M1	70-25		30-120		30-90		30-60	364982X1	40-20	3901361M1	60-150
	70-30	1713981	30-105		30-95		30-65	366573X1	10-40	3901362M1	60-150
1109055	40-5		30-120	353440X1	50-95		50-20		30-40	3901363M1	60-150
	40-10	1713999	30-120	353445X1	20-45		50-75		60-100	3901364M1	60-150
	40-15	1714005	30-120		60-85		50-115	368270X1	20-25	3901365M1	60-150
11113421	10-65	1892056M1	30-40	353446X1	30-40		50-120	368443X1	70-5	3901366M1	60-150
1124697	10-40	19575X	40-20		60-15		60-20	369066X1	60-100	3901367M1	60-150
12225	70-75	210371	10-20		60-35		60-40	369358X1	60-155	3901368M1	60-150
13223X	10-20		10-25		60-45		60-50	373197X1	80-95	3901369M1	60-150
	10-25		10-30		60-155		60-60	373575X1	60-145	3901370M1	60-150
	80-65	235663	50-25		70-5		60-85	373839X1	60-20	3901371M1	60-150
	80-70	2401516P	50-110	353669X1	60-100		80-95		60-25	3901379M1	30-40
1427996M1	30-5	26260	20-60	353681X1	60-35	354273X1	70-55	375095X1	60-155	3901380M1	30-40
	30-100	26922	40-65		60-45	354289X1	10-25	375098X1	80-45	3901381M1	30-40
1440641X1	60-150	2700076	10-55	353687X1	60-110		80-65	375099X1	50-5	3901382M1	30-40
1440643X1	60-150		10-60	353689X1	30-40		80-70		60-155	3901383M1	30-40
159723	20-50	27342	10-15	353691X1	30-40	354655X1	10-20		50-95	3901384M1	30-80
1663157P	10-5	278523	20-45		30-70		80-65	3760032M1	30-100	3901391M1	60-150
	10-10	3009695X1	10-65		60-100	355217X1	10-85	3901284M91	60-100	3901495M1	60-100
	80-60		10-70		70-5	355565X1	30-40	3901286M91	60-100	3901496M1	60-100
1663158P	10-5	300974M1	60-155	353693X1	50-165		60-15	3901288M1	60-100	3904020M1	60-150
	10-10	300975M1	60-155	353724X1	60-100		60-35	3901289M1	60-100	3904021M1	60-150
	80-60	317818	20-45	353726X1	50-5		60-45	3901294M1	70-5	3904022M1	60-150
1663159P	10-5	329264M91	20-15	353727X1	40-55		70-5	3901299M1	30-40	3904523M91	10-85
	10-10		20-20	353729X1	20-25	355566X1	30-40	3901300M1	30-40		10-90
	80-60		20-25		20-50		30-70	3901301M91	30-40	3904527M91	10-95
1663161B	10-5	329266M91	20-15		20-55		70-5	3901302M91	30-40	3904529M91	10-95
	10-10		20-20		50-5	355619X1	10-40	3901303M91	30-5	3904530M91	10-85
	80-60		20-25		50-10		80-40	3901305M91	30-40		10-90
1663162B	10-5	329277M91	20-25	353754X1	60-100	355919X1	50-25	3901306M1	30-80		10-100
	10-10	329278M91	10-95	353756X1	30-40		50-40	3901308M1	30-40	3904692M91	60-150
	80-60		10-100		60-100	360030X1	30-5	3901309M1	60-100	390735X1	60-100
1663163	10-5	329420M91	20-25	353768X1	60-155		30-10	3901310M1	30-80	390972X1	60-55
	10-10	329421M91	10-95	353769X1	30-5	360256X1	60-100	3901311M91	30-80	41145	30-70
	80-60		10-100		30-10	361078X1	60-145	3901312M1	80-10		30-75
1695966M1	30-95	3384597M1	60-145		30-15	3619622M1	30-20	3901313M1	80-10	41681	30-70
	30-125	3387318M1	30-95		30-90	363905X1	80-40	3901315M91	30-80		30-75
			30-125		60-75		80-45	3901316M1	10-20	457432	10-5
		339375X1	80-95		60-80	363906X1	80-40	3901319M91	60-145		10-10

**NUMERICAL INDEX
INDEX NUMERIQUE
NUMMERN-INDEX
INDICE NUMERICO
INDICE NUMERICO**

G2

47142	20-15 20-20 20-25	621235M1	30-40 30-45 30-55	65052	60-15 60-20 60-25	6526164P	10-85 10-90 10-45	6549588P 6553259P 6553267	20-30 50-30 50-30	6844674 6844682P	60-75 60-80 60-65
50393	40-5 40-10 40-15	62174	30-65 10-15 50-95	6514772	50-80 60-35 60-40	6529317 6529408 6529432	60-10 60-10 60-10	6553275	50-30 50-45 70-55	6844724 6844773P	60-70 40-45 50-25
51292	20-15 20-25 20-30	62182	50-105 50-110 70-15	6518302B	60-45 60-50 40-70	6529564 6529655 6529671P	80-50 80-50 80-50	6553804 6561351P 6564512	50-45 50-55 60-120	6844823 6844971 6845077P	50-95 50-20 50-50
51318	10-15	62190	50-60		80-40		80-55		60-55		50-60
52233	40-55 50-5 50-10	6229462P	50-65 50-70 20-50	6521868	10-45 80-30 20-30	6529705P 6529713 6529739B	80-50 80-50 30-70	6564595	60-60 60-85 60-110		50-65 50-85 50-85
52761	60-10	62307	20-55 20-15 40-25	6522668P 6522700P	20-30 20-50 20-55	6529747B	30-70 30-70 30-75	6564769 6564785B 6564819	60-110 60-110 60-110	6845101P 6845135P 6845507P	40-55 50-85 40-55
52779	50-95		40-35 80-45 80-45	6522866P	10-40 10-105 10-40	6529945	50-20 50-75 50-120	6564827 6564975 6564983	60-110 60-110 20-30	6845598 6845713P 6845721P	50-40 40-55 50-20
58024B	50-110 80-45 10-105	6232946P	40-70 50-5 80-40	6522932 6523229 6523500	10-40 50-30 50-25	6530232	50-95 50-105 50-95	6565014 6565030 6565675P	50-25 10-105 40-60	6845879P 6845929 6848832P	20-50 20-55 50-15
58107B	20-30 20-30 50-45	6234710	50-105 50-110 80-45	6523518 6523534	50-40 50-25 50-40	6530265 6530307P	50-95 50-95 50-105	6579106P	10-55 10-85 10-90		50-60 50-65 50-70
58511	50-110 60-90 50-20	62463	60-35 20-40 60-75	6523542 6523617P	50-25 50-50 50-55	6530364P	50-5 50-10 50-5		6579742P 6591366 6591457	6849160 6849178	50-10 50-5 60-55
58859	50-60	6270854	60-80 50-10 60-80	6523740P	50-50 50-55 50-55	6530398P	50-10 50-10 50-95		6591465 6591549P 6591564		60-80 60-120 80-15
58875	60-75	62786	60-80 60-80 40-55	6523799	30-20 50-20 50-30	6530471P 6530489P	50-95 50-95 50-105	6591572	50-25 50-25 50-25		50-10 50-10 80-15
58925B	60-75	6280085	50-60 70-5 50-25	6523807	10-15	6530588P	80-45 50-95 50-105	6591580	50-35 50-35 50-15	68619	10-15 10-95 20-35
58941	60-80 40-55 40-55	63495	50-60 70-5 50-25	6524003P	10-15		50-95 50-105 50-110	6591614P	50-15 70-55 50-35		20-40 40-5 40-65
6105159	40-55	63586	50-25 50-50 50-55	6524623P	50-40		50-95 50-110 50-5	6605315	50-35 50-15 50-35		60-75 70-55 40-5
6105621P	20-15		50-50 50-55 50-120	6524649P	50-40	6530604	50-10 20-15 20-25	6613624P	50-35 50-120 50-45		40-5 40-65 50-25
6141311	20-25	63693	50-125 20-55 70-5	6524870P	40-50 50-95 40-50	6530638P	20-15 20-25 50-95		6818546 6818561		50-15 50-15 20-25
61572	40-5 40-10 40-15		70-15 20-30 10-15	6524946P 6525042P	40-50 40-50 50-95		50-95 50-105 50-110		6823512P		20-25 50-95 10-20
6179246	10-85 10-90 40-50	63800	10-15 60-20 60-25	6525455 6525471P	40-5 40-10 40-15		50-110 50-95 50-105		6844625 6844633P		50-35 70-55 50-95
6179832P	40-50	63883	60-20 60-25 70-15		10-85	6530646P	50-110 50-105 50-110		6844633P		60-75 60-75 60-15
61978	40-50	6477723	60-20 60-25 70-15		10-85		50-85 50-85 50-95				60-15 60-15 60-105
6201404	40-25 40-35 50-75	6488431	60-75 60-80 10-15	6526016 6526081	10-85 10-85 10-90						
62018	20-50	6489231	60-80 10-15		10-90						
62117	20-55 50-75										

**NUMERICAL INDEX
INDEX NUMERIQUE
NUMMERN-INDEX
INDICE NUMERICO**

G3

700108569P	60-15	700112881	40-25	700113013P	10-70	700113196	20-5	700113336P	50-20	700113643P	20-35
	60-105	700112882P	40-50		10-80	700113199	20-15	700113342P	50-20		20-40
700108570	60-15	700112885P	40-25	700113014	10-65	700113206	20-50	700113345P	50-50	700113645	20-25
	60-105		40-35	700113015	10-70	700113229	20-15		50-55	700113646B	10-5
700108622P	20-15	700112886P	40-35	700113017	10-65	700113235	20-15	700113346	50-20		10-10
700108820	10-40	700112887P	40-30	700113018	10-65	700113239	20-15	700113353P	50-135		80-60
	10-105	700112892	40-25	700113022	10-15	700113244P	20-10		50-140	700113660P	40-60
700109753P	10-95		40-35	700113023P	10-55	700113247	20-35	700113359	50-135	700113661	40-5
	10-100	700112893P	10-15	700113036	10-40		20-40		50-140		40-10
	40-10	700112899	10-105	700113037	10-40	700113248	20-35	700113360	50-135	700113663	40-5
	40-15	700112903P	10-40	700113038	10-45		20-40		50-140		40-10
700110198	20-55		10-105	700113039P	10-15	700113254P	20-30	700113361P	50-135	700113666P	40-5
700110467P	10-15	700112906	10-85		80-65	700113257P	20-30		50-140		40-10
700112787P	40-20	700112909	10-85	700113042P	10-50	700113259P	20-30		50-230	700113671P	50-175
700112800P	40-45	700112915	10-85	700113044P	10-45	700113260	20-30	700113362M	50-95		50-180
700112802	40-45		10-90	700113045P	10-45	700113269	20-35	700113532	60-125	700113687	50-145
700112803	40-45	700112919	10-95	700113046	10-55	700113270	20-35	700113533	60-125		50-175
700112811P	40-45		10-100	700113047P	10-50	700113276	20-35	700113538	60-125	700113690	50-155
700112812	40-5	700112923	10-45	700113052P	10-15	700113281P	20-35	700113539	60-125		50-175
700112814P	40-45	700112925	10-95	700113054P	10-15		20-40	700113540	60-125		50-205
700112815P	40-5		10-100	700113057	10-15	700113283	20-50	700113541	60-125	700113862	50-160
	40-10	700112926P	10-95	700113058P	10-15	700113287P	20-50	700113577P	60-10	700113863	30-5
	40-15		10-100	700113065	10-55		20-55	700113586P	60-10		30-10
700112817P	40-20	700112930P	10-85	700113091	50-60	700113291	20-25	700113594P	60-5		30-90
700112819P	40-45		10-90	700113093P	50-60	700113292P	20-50	700113600P	60-5	700113890	50-150
700112823	40-20	700112931	10-85		50-65		20-55	700113601P	60-5		50-175
700112825P	40-5	700112932	10-85		50-70	700113296P	20-50	700113604P	60-5	700113952	60-30
	40-10	700112933	10-85	700113095	50-5		20-55	700113606P	60-5	700113953P	60-30
	40-15		10-90		50-10	700113297P	20-25	700113607	60-5	700113954	60-35
700112826P	40-5	700112940	60-155	700113098P	50-5	700113299P	20-35	700113608P	60-5	700113955	60-45
	40-10	700112942P	60-155		50-10		20-40	700113609P	60-10	700113973M	60-35
	40-15	700112985	10-65	700113105P	50-95	700113300P	20-35	700113610P	60-10	700113974M	60-45
700112833P	40-55		10-80		50-105		20-40	700113611	60-10	700113975	60-35
700112838P	40-55	700112988	10-70		50-110	700113304P	20-35	700113615	60-10		60-45
700112840P	40-35		10-75	700113170	40-65		20-40	700113616P	60-5	700113980	60-35
700112842	40-25	700112989	10-65	700113171	40-65	700113305P	20-35	700113617P	20-10	700113981	60-45
700112856P	40-30		10-75	700113172P	40-60		20-40	700113619P	20-10	700113982	60-35
700112857	40-30	700112991	10-65	700113176P	40-65	700113307M	50-15	700113620P	20-10	700113983	60-45
700112858	40-30		10-75	700113177	40-65	700113310	50-25	700113622P	20-10	700113986	60-15
700112859P	40-30	700112992	10-65	700113178	40-65	700113311	50-20	700113623P	20-10	700113988P	60-30
700112860P	40-35		10-75	700113184P	40-65	700113321P	50-25	700113625P	20-10	700113989P	60-35
700112866P	40-50	700112993P	10-70	700113185P	40-65		50-30	700113634P	80-70		60-40
700112869P	40-50		10-75	700113186P	40-65		50-35		80-75		60-45
700112872P	40-50	700113003	10-65	700113187P	40-65	700113323P	50-30	700113636P	20-35		60-50
700112875P	40-40	700113004	10-65	700113188P	40-65	700113325	50-25		20-40	700113990P	60-35
700112876P	40-25	700113011	10-70	700113189	40-65	700113328P	50-25	700113638P	20-35		60-40
	40-35	700113012	10-70	700113192P	40-60	700113329	50-40		20-40		60-45
700112880P	40-25		10-70	700113193P	40-60	700113330P	50-20	700113640	70-5		60-50

**NUMERICAL INDEX
INDEX NUMERIQUE
NUMMERN-INDEX
INDICE NUMERICO
INDICE NUMERICO**

G5

700137258	40-60	700138876P	20-25	700150685P	60-30	700700036	80-20	700706032	10-70	700706082	10-70
700137336P	40-15	700138991	10-60		80-85	700700057	20-20		10-80	700706086	10-70
700137466P	50-80	700139232	80-55	700150687	60-40		20-25	700706033	10-65	700706087	10-40
700137467P	50-80	700139255	50-90	700150689	60-40	700700502	10-70		10-80	700706088	10-70
700137469P	50-65	700139336	50-55	700150690	60-30	700700628	20-45	700706034	10-70		10-80
	50-70		50-70	700151957	60-90		60-20		10-80	700706089	10-65
700137477P	50-65		50-90	700151958	60-90		60-25	700706038	10-45		10-80
700137486P	50-40	700139338	50-55	700152204P	60-40		60-40	700706039	10-45	700706090	10-65
700137490P	50-100		50-70	700152205P	60-50		60-50	700706040	10-65		10-75
700137492	50-100		50-90	700152206P	60-50		60-60		10-75	700706091	10-65
700137654P	60-5	700139339P	50-90	700152213P	10-45	700700968	50-30	700706041	10-70		10-75
700137655P	50-50	700139363M	60-60	700152226	60-115		50-35		10-75	700706092	10-65
	50-55	700139376	60-105	700152228	80-45		50-120	700706045	10-45		10-75
700137750P	20-15	700139760	10-100	700153111	10-75		50-125		10-70	700706096	40-20
	20-20	700148820	80-45	700153217	50-5	700701753	70-55		10-80	700706097	40-5
700138067	30-25	700149700P	60-135		50-10		50-5	700706046	10-65		40-10
700138074	30-5		70-60	700153220P	70-10	700703458	50-10	700706048	10-65	700706110	10-85
700138219	50-100	700149701P	70-60	700153226P	60-25		30-25	700706049	10-70		10-90
700138224	50-100	700149702P	70-60	700153227M	60-25	700703830	10-10		10-75		10-100
700138225	50-100	700149704	70-70	700153506P	10-15	700703922	20-25	700706050	10-45	700706111	10-85
700138238	20-45	700149710	70-70	700153507P	10-15		20-55	700706056	10-45	700706124	40-65
700138239	20-45	700149712	70-70		80-75		40-55	700706057	10-45	700706125	40-65
700138809	20-5	700149714	70-70	700153509	50-20		50-10	700706058	10-45	700706131	40-20
700138821	20-20	700149718	70-70	700153514	50-20		50-105	700706059	10-45	700706133	40-20
700138825P	60-95	700149719	70-70	700153598	80-55		50-110	700706060	10-45	700706134	40-20
700138827P	20-20	700149720P	70-55	700153603	80-55		80-45	700706061	10-45	700706142	10-70
700138828P	20-20	700149723P	70-55	700154434	30-15		80-55	700706062	10-50	700706144	10-70
700138829P	20-20	700149725P	70-55	700154471	30-95		80-60	700706063	10-50		10-75
700138830P	20-20	700149726P	70-60	700154495	50-20	700703923	20-40	700706064	10-50	700706146	50-5
700138835P	20-20	700149735P	70-60	700155835	30-15		50-15	700706065	10-70		50-10
700138838	20-20	700149736	70-60	700155843	30-20		50-95		10-80	700706151	70-20
700138840P	20-45	700149737P	70-60	700157785P	40-20		50-100	700706066	10-70	700706153	70-20
700138844P	50-105	700149741P	70-55	700157788P	40-15	700704132	70-25	700706067	10-70	700706155	70-20
	50-110	700150598	60-130	700160318	80-35		70-30	700706068	10-70	700706156	70-20
700138845	20-20	700150608P	50-15	700163293	10-40	700704263	40-15	700706070	10-70	700706194	60-155
	20-25	700150609	50-20	700163299	20-45	700705088	30-60		10-80	700706269	50-20
700138846P	20-25	700150610P	50-20	700163367M	60-5		30-65	700706071	10-70	700706276	50-135
700138851P	30-55	700150621	50-5	700163376	30-65		60-85		10-80		50-140
	30-65		50-10	700163377	30-65	700705158	80-15	700706072	10-70		50-230
700138852	60-20		50-60	700163719	50-185	700705185	30-60		10-80	700706277	50-135
	60-25	700150622	20-5	700164420	10-10	700705612	20-15	700706073	10-70		50-140
700138856P	50-25	700150626	20-15		80-60	700705617	50-195		10-80		50-230
700138857	50-30	700150652	20-45	700164429	10-60	700706027	10-70	700706074	10-65		50-240
700138858	50-30	700150653P	20-45	700164437	10-60		10-80	700706075	10-65	700706279	40-25
700138869	40-25	700150655	60-20	700164445	50-90		10-70	700706076	10-65		50-140
	40-35		60-25	700164637	10-40	700706029	10-80	700706078	10-65		50-230
700138871P	10-105	700150657P	70-10	70068847	10-65	700706030	10-70	700706079	10-65	700706280	50-135
700138873P	40-10	700150670	50-125		10-80		10-80	700706080	10-65		50-240

**NUMERICAL INDEX
INDEX NUMERIQUE
NUMMERN-INDEX
INDICE NUMERICO
INDICE NUMERICO**

G 6

700706281	50-130	700706412	30-5	700706678	50-210	700706840	50-145	700707016	30-5	700707998	10-40
700706282	50-130		30-10		50-225		50-175		30-120	700708000	10-70
700706284	50-165	700706413	30-100		50-235		50-235	700707203	60-15		10-75
	50-170		30-115		80-85		50-240		60-20	700708036	30-40
700706285	50-165		30-120	700706679	50-145	700706841	50-150		60-25	700708037	10-70
700706287	50-165		30-125		50-160		50-200	700707250	10-40		10-75
700706288	50-165	700706414	30-115		50-175		50-210	700707294	30-85	700708038	10-55
	50-170	700706415	30-115		50-235		50-215	700707295	30-85		10-60
700706300	80-80	700706419	40-60		50-240		50-220	700707296	30-85	700708039	10-55
700706338	70-45	700706459	30-5		50-245		50-225	700707318	70-50		10-60
	70-50	700706493	80-10	700706682	50-175		50-235	700707377	30-85	700708041	10-55
700706340	30-5	700706501	30-70		50-235		80-85	700707378	30-85		10-60
	30-10		30-75		50-240	700706843	50-160	700707382	30-85	700708048	20-60
	30-90	700706502	30-70		50-245		50-240	700707383	30-85	700708076	70-70
700706376B	50-50		30-75	700706683	50-175	700706850	40-20	700707418	70-40	700708190	80-20
	50-55	700706503	50-115		50-235	700706852	10-90	700707419	70-40	700708270	10-15
	60-5	700706539	50-135		50-240		40-65	700707457	30-85		80-75
700706377	60-5		50-140		50-245	700706856	80-10	700707474	30-90	700708333	30-110
700706386	70-20		50-230	700706684	50-235	700706898	50-135		30-95	700708334	70-5
700706387	70-5	700706540	50-135	700706685	50-50		50-240		50-120	700708335	70-45
	70-20		50-140		50-55	700706953	10-25		50-125	700708343	10-65
700706388	70-5		50-230		60-5		80-70		50-240		10-70
	70-10	700706541	50-135	700706703	70-5	700706954	10-25	700707598	30-85	700708348	10-10
700706389	70-5		50-140	700706798	50-145		80-70	700707619	30-45		10-45
	70-10		50-230		50-175	700706955	10-40	700707677B	60-75		80-60
700706391	70-5	700706542	50-135		50-180	700706956	10-40		60-80	700708349	10-65
	70-15		50-140		50-185	700706957	10-40	700707683	30-85	700708350	10-70
700706392	70-45		50-230	700706809	80-10	700706966	10-20	700707769	10-70	700708353	10-65
700706393	70-5	700706543	50-135		80-15		10-30	700707817	30-115		10-70
700706398	30-5		50-140	700706835	50-145		80-65	700707818	30-115		10-80
	30-10		50-230		50-150	700706990	80-20	700707819	30-115	700708355	10-45
	30-30	700706548	40-55		50-235		80-25	700707820	30-115	700708358	10-70
	30-90	700706602	70-20	700706837	50-155	700706999	30-105	700707826	70-20		10-75
	30-95		80-80		50-205		30-115	700707832	70-20	700708367	10-70
700706399	30-105	700706604	70-20		50-210	700707001	30-105	700707858	60-15	700708583	80-10
	30-110	700706605	70-20		50-220		30-115		60-105		80-65
	30-115	700706609	70-20		50-235	700707002	30-105		20-15		80-70
700706400	30-100	700706633	80-10		80-85	700707002	30-115	700707867	20-20	700708625	70-50
	30-105		80-15	700706839	50-150	700707003	30-105	700707960	10-20	700708626	70-50
	30-110	700706642	30-5		50-200		30-115		10-25	700708648	60-15
	30-115		30-40		50-210	700707004	30-105		10-30		60-20
	30-120	700706643	10-95		50-215		30-115		80-10		60-25
	30-125		10-100		50-220	700707011	50-175		80-65	700708653	20-10
700706401	30-105	700706645	30-5		50-225		50-180		80-70		40-55
	30-110	700706646	30-5		50-235	700707012	50-185	700707991	10-45	700708753	30-105
	30-120		30-120		80-85	700707013	30-110	700707993	10-45	700708756	30-120
	30-125	700706647	80-20			700707014	30-110	700707996	10-55	700708757	30-110

**NUMERICAL INDEX
INDEX NUMERIQUE
NUMMERN-INDEX
INDICE NUMERICO**

G7

700708758	30-110	700709986	70-5	700711091	80-10	700712134	30-85	700713300	30-5	700714572	80-15
	30-115		70-15	700711112	70-40	700712135	30-85		30-120		80-25
700708760	30-105		70-20	700711165	10-45	700712443	10-20	700713576	30-115	700714585	80-15
	30-110	700709996	30-25		80-55		80-65	700713657	10-70	700714586	10-15
	30-115	700710039	80-10	700711198	10-15	700712444	10-20	700713889	10-5		20-15
700708761	30-100	700710040	80-20		80-75		80-65	700713922	10-5		20-20
	30-105	700710041	80-10	700711238	10-15	700712445	10-20	700714008	50-145		20-25
	30-115		80-20		10-100		10-30		50-150		20-40
700708963	30-105	700710049	40-55		20-15		80-65		50-155		40-10
	30-115	700710072	10-55		20-45	700712446	10-20		50-200		40-15
700708964	30-105		10-60		30-15		80-65		50-205		50-15
	30-120		10-85		30-20	700712447	10-20		50-215		50-105
700709175	30-105		10-90		30-25		80-65		50-220		50-110
	30-115	700710176	70-20		30-30	700712467	30-100		50-235	700714617	80-15
700709216	80-80	700710188	30-5		30-35		30-115	700714047	80-55	700714660	80-15
700709232	30-110		30-25		30-65	700712474	10-20	700714053	80-55	700714661	80-15
	30-115		30-55		40-10		80-65	700714066	80-55		80-25
	30-120		30-65		40-15	700712475	10-20	700714067	80-15	700714662	80-15
700709233	30-100	700710189	30-25		40-45		80-65	700714074	80-15		80-25
	30-110	700710208	30-25		40-55	700712484	50-20		80-25	700714721	30-45
	30-120	700710211	30-10		50-15	700712517	10-20	700714164	80-25	700714829	30-110
700709354	30-105		30-20		50-65		10-25		80-45		30-120
	30-120		30-25		50-70		10-30	700714166	50-100	700714985B	50-20
700709636B	50-110		30-95		50-105		10-35	700714199B	20-15	700714986B	50-60
700709704	30-110	700710263	10-50		50-110		80-65		20-20		50-65
	30-120	700710264	10-50		60-20		80-70	700714229	80-20		50-70
700709705	30-120		10-55		60-25	700712579	10-20	700714418	80-15	700714987B	40-55
700709706	30-115	700710290	30-40		70-10		10-25	700714440D	80-100	700714990	60-135
	30-120	700710312	60-10		70-55		80-65	700714441	60-145		60-140
700709708	30-110	700710413	50-5		70-60		80-70		60-155	700714993	60-135
	30-120		50-10		80-45	700712767	10-30	700714506	80-5	700714994	60-135
700709850	20-45	700710414	50-5	700711425	10-35		10-35	700714528	20-45	700715004	60-135
700709866	60-20		50-10	700711509	10-5	700712821	70-25		60-20	700715006	60-135
	60-25		50-40	700711557	50-105		70-30		60-25	700715020	10-30
	80-15	700710620	30-115		50-110	700712823	70-25		60-40	700715024	10-30
	80-20		30-120		80-45		70-30		60-50	700715035	10-30
	80-25	700710659	30-120	700711659	30-25	700712824	70-25		60-60	700715051	80-15
700709867	80-15	700710805	50-235	700711660	30-85		70-30	700714529	20-45	700715143	30-45
	80-20	700710807	50-230		30-120	700712845	30-85		60-20		30-55
	80-25	700710928	10-30	700711751	50-135	700712846	30-5		60-25		30-65
700709911	30-105		80-65		50-140	700712896	30-120		60-40	700715153	80-25
	30-115	700710946	40-40	700711829	30-120	700712917	70-25		60-50	700715154	80-15
	30-120		50-45	700711860	70-10		70-30		60-60	700715155	80-15
700709957	80-80	700710949	70-65	700711918	20-55	700712924	70-25	700714532	80-5	700715156	80-25
700709960	50-5	700710972	70-70	700711954	70-40		70-30	700714533	80-5	700715157	80-15
	50-10	700710984	10-15	700712102	30-85		30-5	700714545	80-5		80-25
700709979	60-40	700711025	20-30	700712132	30-110	700712983	30-120	700714570	80-15	700715158	80-25
	60-50	700711084	70-55		30-115					700715159	80-15

**NUMERICAL INDEX
INDEX NUMERIQUE
NUMMERN-INDEX
INDICE NUMERICO
INDICE NUMERICO**

G 8

700715192	80-15	700716246	10-90	700717433D	80-100	700718530	30-100	700719870	30-125	700720109	50-180
700715204	60-135	700716247	10-90	700717444D	80-100		30-115	700719871	30-125		50-185
700715228	60-135	700716267	10-90	700717457D	80-100	700718531	30-100	700720023	10-75	700720111	10-35
700715230	60-135	700716345	30-110	700717627	30-20	700718576	30-100		10-80		80-75
700715343	80-100	700716375	70-10	700717684	10-75		30-115	700720027	10-75	700720112	10-30
700715345B	80-100	700716376	70-15	700717685	10-75	700718581	30-110	700720050	20-15	700720113	10-35
700715347B	80-100	700716382	10-60		10-80	700718588	30-115		20-20	700720121	10-30
700715349A	80-100	700716383	10-60	700717687	10-80	700718590	30-100	700720062	10-25	700720122	10-20
700715415	50-170	700716454	30-110	700717688	10-80	700718599	30-125		80-70		10-30
700715459	50-165	700716461	30-45	700717695	70-70	700718604	30-105	700720082	50-210	700720131	80-15
	50-170		30-55	700717696	70-70		30-115		50-225	700720132	10-5
700715514	30-45		30-65	700717705	70-70	700718605	30-105		80-85		10-10
700715549C	80-100	700716463	70-15	700717713	70-70		30-110	700720083	50-210	700720152	10-35
700715627	50-35	700716598E	80-100		70-75		30-115		50-225	700720153	10-30
	50-120	700716611	40-15	700717759	70-70		30-120		80-85		10-35
700715662	70-20	700716624	10-5		70-80	700718607	30-105	700720087	50-180	700720180	10-5
700715684	60-145		10-10	700717760	70-55		30-115		50-195		10-10
700715694	30-45		80-60	700717761	70-55	700718608	30-105		80-85	700720181	10-5
700715751	40-15	700716685	10-75	700717865	70-55		30-115	700720091	50-200		10-10
700715820	10-30	700716724	30-35	700717866	70-60		30-120		50-205	700720228	30-5
	10-35	700716772	30-45		70-65	700718613	30-110		50-210		30-10
700715824	10-35		30-55	700718082	70-10	700718614	30-110		50-215	700720230	10-30
	80-75		30-65	700718110	50-180	700718618	30-110		50-220	700720231	10-5
700715825	10-35	700716805	60-140		50-200	700718638	30-110		50-225		10-10
700715826	10-35	700716806	60-140	700718111	50-180	700718683	30-110		80-85	700720233	70-15
700715827	10-35	700716807	60-140		50-205	700718702	70-75	700720092	50-200		70-25
700715929	70-25	700716808	60-140	700718112	50-180	700718703	70-75		50-205	700720302	30-85
	70-30	700716809	60-140		50-210	700718704	70-75		50-210	700720414	60-135
700715941	50-80	700716810	60-140	700718113	50-200	700718710	50-35		50-215	700720416	60-135
700715958	60-135	700716812	60-140	700718123	50-200		50-120		50-220	700720423	60-135
700715959	60-135	700716813	60-140	700718124	50-205		50-125		50-225	700720550	30-15
700715980	10-50	700716814	60-135	700718125	50-205	700718774	70-65		80-85	700720579C	80-100
	10-75	700716838	80-95	700718126	50-210	700718962	50-225	700720095	50-210	700720586	30-125
	10-80	700716842	30-15		50-225		80-85		50-225	700720644	80-80
700715981	10-75	700716903	70-25		80-85	700718963	50-210		80-85	700720654	30-125
700715982	10-80		70-30	700718127	50-210		50-225	700720096	50-210	700720655	30-125
700715983	10-80	700716952	10-75		50-225		80-85	700720097	50-200	700720679	80-80
700715984	10-75	700716972	60-135	700718128	50-210	700719201	70-25		50-215	700720699	80-5
700715985	10-80		60-140		50-225		70-30		50-225	700720700	80-5
700715986	10-75	700716973	60-140		80-85	700719282	30-115	700720098	50-245	700720762	30-125
700715988	10-75	700717218	70-25	700718129	50-210	700719293	30-120	700720099	50-195	700720764	30-125
700715989	10-75	700717250D	80-100		50-225	700719297	30-120	700720100	50-195	700720765	30-125
700715991	10-80	700717386	30-45		80-85	700719423C	80-100	700720101	50-195	700720766	30-125
700715992	10-80		30-55	700718131	50-10	700719614	30-110	700720103	50-195	700720800	30-125
700716158	20-15		30-65	700718206	70-60	700719636	30-10	700720104	50-195	700720801	30-125
	20-20	700717417	30-45	700718207	70-55	700719863	30-125	700720105	50-195	700720802	30-125
700716244	10-90		30-55	700718483	70-60	700719868	30-125	700720106	50-195	700720804	30-100
700716245	10-90		30-65	700718484	70-60	700719869	30-100	700720108	50-195	700720807	30-125

**NUMERICAL INDEX
INDEX NUMERIQUE
NUMMERN-INDEX
INDICE NUMERICO
INDICE NUMERICO**

G9

700720916	80-80	700723222	30-100	700725829	70-15	7027469	60-145	704247	30-75	704858	10-20
700720952	30-20	700723223	30-100		70-30		60-155		40-5		40-55
700721062	30-115	700723350	40-60	700725832	30-20	7027477	60-145		40-10		60-30
700721590	10-10	700723357	10-10		30-30		60-155		40-15		80-65
700721591	10-10	700723555	70-70	700725925	30-15	7033616	70-70		40-45	705004	30-45
700721617	30-70		70-80	700725961	80-95	70341230	20-60		40-60		30-55
	30-75	700723558	70-70	700726096	80-85	704031	10-15		50-5		30-60
700721775	80-95	700723560	70-80	700726097	80-85		10-85		50-50		30-65
700721800	10-30	700723562	70-80	700726142	30-50		10-90		50-55		50-20
700721913B	80-100	700723642	30-60	700726143	30-55		10-95		50-60		50-75
700721967	80-25	700723738	80-95	700726147	30-100		10-100		50-65		50-115
700721970	80-25	700723782	30-60	700726172	30-50		40-5		50-90		50-120
700722006	80-25	700723828	30-60		30-55		40-25		50-165		60-20
700722199	30-30	700723840	50-185		30-60		40-30		50-170		60-40
700722208C	80-100	700724190	70-10		30-65		40-35		60-15		60-50
700722210	10-50	700724342	80-80		30-75		40-50		60-20		60-60
	10-75	700724470	10-60	700726183	80-90		40-55		60-25		80-95
	10-80	700724601	50-195	700726187	40-10		40-65		60-35	705012	30-5
700722236	70-60	700724602	50-195		40-15		50-20		60-40		30-10
	70-65	700724603	50-195	700726195	80-25		50-25		60-45		30-85
700722237	70-65	700724605	50-195	700726246	80-90		50-95		60-50		30-90
700722351	30-50	700724606	50-195	700726247	80-90		50-105		60-55	705129	30-5
	30-55	700724607	50-195	700726248	80-90		50-110		60-60		30-45
	30-60	700724608	50-195	700726249	80-90		70-60		60-65		30-55
	30-65	700724610	50-195	700726250	80-90	7040330	10-75		60-70		30-65
700722402A	80-100	700724611	50-195	700726495	70-5	704056	10-85		60-85	7052020	10-65
700722532B	80-100	700724612	50-195		70-15		50-105		60-90		10-75
700722533B	80-100	700724618	50-195		70-35		50-110		60-95	705541	10-5
700722534B	80-100	700724619	50-195		70-40		70-60		60-105		10-10
700722535B	80-100	700724620	50-195	700726496	70-40		80-45		60-110		10-15
700722661	50-5	700724621	50-195	700726592C	80-100				60-115		10-85
	50-10	700724837	60-135	701235	20-45			704254	60-120		10-90
	50-20	700724838	60-135		40-60				50-20		20-20
	50-80	700724844	30-65		70-60			704486	60-5		20-25
	50-120	700724950	30-15	701953	60-135				50-30		20-45
	50-125	700725493	80-15	7020019	50-130				60-30		20-60
700722670	20-60	700725527	30-100		50-165			704494	30-60		40-50
700722691A	80-100	700725528	30-100		50-170			704536	40-55		40-65
700722704	70-70	700725529	30-100	702400022	50-30			704551	30-5		50-5
700722759	30-65	700725816	30-15	702400047	60-75			704585	10-5		50-10
700722786	30-60	700725818	30-15		60-80				10-10		50-15
700722922	30-50		80-95	702400048	50-50				80-60		50-20
700723078A	80-100	700725819	30-20		50-60			704601	60-155		50-25
700723079A	80-100	700725821	30-30		50-65			704692	50-10		50-95
700723081A	80-100	700725825	50-180	70248372	20-60			7047541	20-25		50-105
700723082A	80-100		50-185	702700040	50-30						50-110
700723083A	80-100		50-195	702700045	20-15						80-45
700723220	30-100	700725827	70-30								

NUMERICAL INDEX
INDEX NUMERIQUE
NUMMERN-INDEX
INDICE NUMERICO

G 10

705574	40-50 50-65 50-70	70915276	10-40 40-25 40-35	70916950	20-25 30-5 30-10	70917356	30-5 30-10 50-20	70918431	40-55 50-15 50-95	70919624	70-5 70-15 50-95
70575883	20-35 20-40		50-5 50-145		30-75 40-5		60-20 60-25	70918432	20-50 50-25 80-50	70920161	70-5 70-15
7058985	40-55		50-150		40-25		60-40			70920415	20-10
70590709	20-20		50-155		40-35		60-50	70918433	50-95		20-20
706176	10-15		50-200		40-45	70917373	10-5	70918451	50-55		20-25
707448	60-5		50-205		40-50		20-25		60-40		40-65
7078264	80-10		50-210		40-65		20-50		60-50		50-95
7079130	80-20		50-215		50-25		50-45	70918452	20-10		50-105
7087935	10-95		50-220		50-50		80-50		20-50		50-110
7088008	10-95		50-225		50-55	70917377	50-85		20-55		50-170
70901763	50-180 80-85		50-235 80-85		50-85 50-95	70917378	10-40 10-105		40-50 40-55	70920655	50-175 50-180
70901828	10-75	70915751	10-40		60-5		20-30		50-95		50-185
70903835	70-60	70915955	40-25		60-30		40-40		50-105	70921024	50-30
70905129	20-30		40-35		60-65		40-70		50-110	70921176	20-60
70910851	10-45 50-25	70916016	20-30		60-70		50-45	70918454	20-60		40-25
70911020	20-25	70916171	40-30		80-50		50-50	70918455	60-20		40-35
70912269	10-5 10-10 20-15		50-95 50-105 30-5		80-55 80-95 20-25		50-55 50-85 50-90	70918463	60-25 50-5		40-65 50-20
	20-15 20-20 80-60	70916622	30-10 30-85 30-90	70916965	30-5 30-10 30-75		50-85 50-95 50-105	70918787	20-60	70921205	50-25 70-5
70913160	10-85 10-90 10-95 10-100		50-85 30-5 30-10 30-85 30-90		40-5 40-25 40-35 40-50	70917380	50-110 20-45 30-15	70919089	10-85 10-90 50-15	70921206	70-5 70-15 70-60
	20-35				40-65		30-65	70919135	80-55 70-15		70-55 70-60
70914465	10-40 20-50 40-25 40-35 40-50 40-55 50-5 50-10 50-15 50-40 50-95 50-195				50-25 50-30 50-50 50-55 50-85 50-95 60-30 60-65 60-70 80-50 80-55 80-95		50-115 60-20 60-25 60-40 60-50 60-60 80-95 40-65 50-30 50-50 50-20	70919171	50-180 80-85 50-145 50-175 50-240	70921210	70-70 10-15 20-25 30-5 30-10 30-75 40-65 50-30 50-190
	10-40 20-50 40-25 40-35 40-50 40-55 50-5 50-10 50-15 50-40 50-95 50-195				60-30 60-65 60-70 80-50 80-55 80-95	70917421	40-65 50-30 50-50 50-20	70919173	10-100 10-100 40-65 50-15 50-20 50-35 10-40		70-10 80-95 40-30 70-70 70-60 60-115
70915275	10-30 10-35 10-40 10-95 10-100				80-55 80-95	70917642	50-195 60-60 60-115	70919332	10-85 10-90 10-95 10-100		70-10 80-95 40-30 70-70 70-60 60-115
						70918264	50-75		10-105	70921211	70-70
						70918266	80-95	70919423	20-30	70921214	70-15
						70918403	50-50 50-55	70919439	40-40 50-45 70-70	70921217	70-45

NUMERICAL INDEX
 INDEX NUMERIQUE
 NUMMERN-INDEX
 INDICE NUMERICO

G11

70921332	10-15 30-5 30-10 40-55 60-30 60-40 60-50 70-45	70922523 70922598	80-80 50-30 50-120 50-125 40-35	70922786	10-15 10-100 20-15 20-20 20-25 40-5 40-10 40-15 40-45	70923154	10-15 20-50 10-15 70-70 10-5 10-10 10-45 10-55 10-60	70923906 70923938 70924121	30-25 10-105 50-50 50-55 50-25 10-70 10-85 10-90 80-30	70925617	30-5 30-10 30-20 30-25 30-30 30-35 30-40 30-55 30-65
70921333	50-80	70922710	30-60		40-45		10-60	70924741	20-40		50-175
70921349	70-20	70922784	10-20		40-55		20-50	70924744	50-10		50-180
70921360	40-5 40-10 40-15		20-15 30-5 30-10		40-65 40-70 50-50		20-55 40-25 40-30	70924864 70925094	40-35 30-5		50-185 50-190
70921703	50-15		40-5		50-55		50-15		30-10		70-15
70921744	50-15 50-30		40-10 40-15		50-65 50-70		50-30 50-100		30-15 30-20	70925619	80-85 30-5
70921882	30-30		40-45		50-105		60-10		30-25		30-15
70921885	70-15		50-105		50-110		80-50		30-35		30-20
70921911	50-175 50-180 50-185 50-190		60-55 60-120 80-45		60-20 60-25 60-30 60-65	70923220	80-55 80-60 40-5 40-10		30-40 30-50 30-55 30-60		30-30 30-50 30-55 30-60
70921963	40-55				60-70		40-15		30-65		30-65
70921965	30-5 30-10 50-175 50-180 50-185				60-85 60-90 60-95 70-60		40-50 40-70 50-15 50-25		30-70 30-75 30-85	70925705	20-50 20-55 20-35
70921969	40-25 40-35 40-50 50-175 50-180 70-10				80-40 80-45 80-50 80-55		50-95 50-105 50-110		50-135 50-140 50-160	70925721 70925731	50-20 50-15 50-40
70921971	30-45 30-55 30-65 40-65				80-50 80-55 70-15		60-5 70-70		50-180 50-190 60-135	70926049	30-5 30-10 30-30
70921977	30-20 50-20 60-40 60-50				40-55 60-35 60-45 60-155	70923306	50-40 40-55	70925149	80-85 50-95		50-175 50-180
70921978	60-115				60-45	70923320	40-35	70925387	10-50		50-185
70922127	60-20 60-25 60-115				50-5 50-10	70923326	50-30		10-85 10-90		50-190 60-135
70922135	50-30				50-15	70923434	50-120	70925442	80-80		70-5
70922322	70-45				70-5 70-15 70-5		50-125 10-5 10-10				70-10 70-55
					70-15	70923501	80-60				80-85
					50-45		50-35				50-15
					60-145	70923561	10-70			70926127	60-110
					50-175	70923593	10-75			70926150	60-110
					50-180		10-80			70926673	30-15
					50-185	70923596	70-60				30-15
					60-30	70923717	80-80				60-25
						70923894					

NUMERICAL INDEX
 INDEX NUMERIQUE
 NUMMERN-INDEX
 INDICE NUMERICO

G 15

Y704734	10-15 20-10 20-15 20-20 20-25 30-45 30-50 30-55 30-60 30-65 40-70 50-10 50-105 50-110 50-175 50-180 50-185 50-190 60-105 60-135 70-5 70-10 70-15 70-70 80-40 80-85	Y705046	10-15 10-85 10-95 10-100 20-15 40-5 40-25 40-30 40-35 40-60 40-65 50-20 50-25 50-30 50-35 50-95 70-60 20-40 20-45 30-15 30-20 30-30 30-35 30-40 50-195 60-15 60-20 60-25 60-30 60-35 60-40 60-45 60-50 60-60 60-65 60-90 70-5 70-10 70-15 70-45 70-55	Y705533	10-15 20-10 20-15 20-20 20-25 20-40 30-15 30-20 30-25 30-40 30-70 30-75 40-5 40-10 40-15 40-45 40-50 40-65 50-15 50-25 50-95 50-105 50-110 60-5 60-25 60-30 60-65 60-70 70-10 70-60 80-45 10-55 10-60 10-85 10-90 10-95 10-100 20-60 30-30 40-60 50-15 60-10 60-145	Y705582	20-25 20-50 20-55 50-5 50-15 50-45 50-50 50-55 60-5 50-115 60-5 60-5 40-30 50-40 20-20 20-15 20-30 50-20 40-70 80-40 30-5 30-45 30-50 30-60 10-65 10-75 50-240 10-95 10-5 10-10 80-60 40-25 40-35 80-50 80-55 40-15	Y706549 Y707042 Y707240 Y708230 Y710293 Y710392 Y740068 Y740787 Y745216 Y746354 Y746461 Y747931 Y762260 Y766113 Y852947
Y704742	10-5 10-10 10-15 10-85 10-90 20-15 20-25 20-35 20-45 20-50 20-55 20-60 40-20 40-55 50-175 50-180 50-185 80-30 80-55	Y705525	20-40 20-45 30-15 30-20 30-30 30-35 30-40 50-195 60-15 60-20 60-25 60-30 60-35 60-40 60-45 60-50 60-60 60-65 60-90 70-5 70-10 70-15 70-45 70-55	Y705566				

10

Hitch Safety Chain – Jack
 Chaîne De Securite – Cric
 Sicherheitskette – Abstellstuetze
 Catena Sicurezza – Martinetto
 Cadena Seguridad – Gato Armado

10-5

➔ HP 91100

5-BA39-002-D

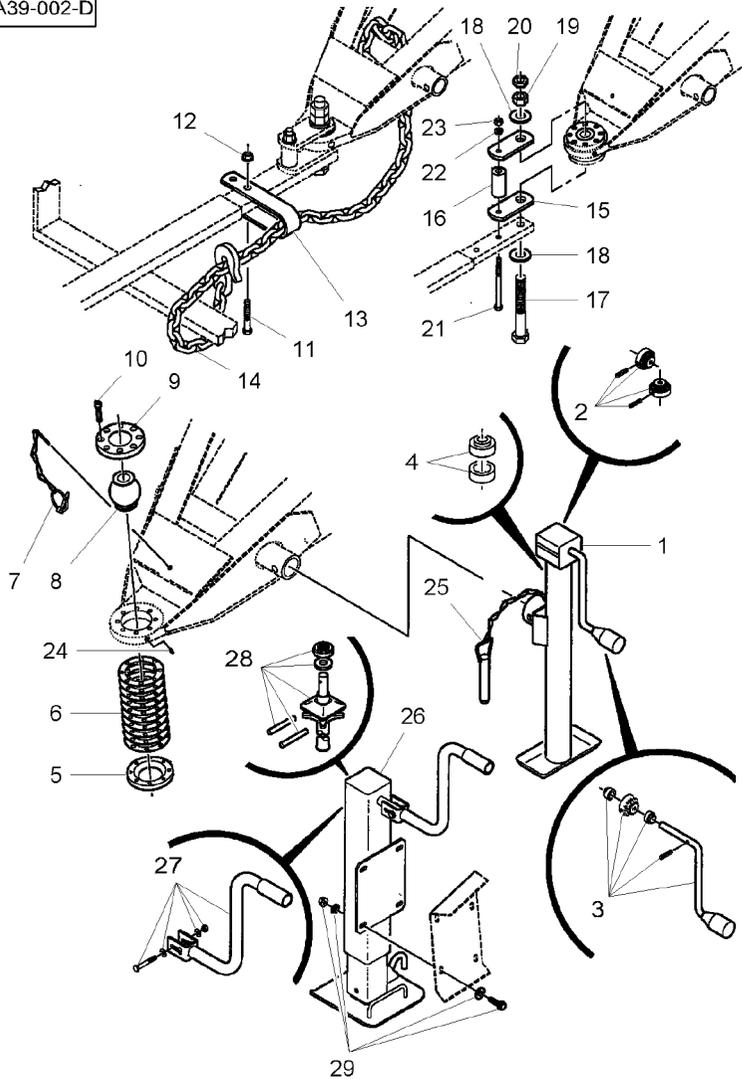

1	700713889	➔ HK 91220	1 JACK	CRIC MARTINETTO	WAGENHEBER GATO
2	WR21126	2	1 KIT, GEAR	JEU ENGRENAGES KIT INGRANAGGI	ZAHNRADSATZ ENGRANAJES JUEGO
3	700711509	2	1 CRANK	MANIVELLE MANOVELLA	KURBEL MANIVELA
4	744720	2	1 KIT, BEARING	JEU COUSSINETS KIT CUSCINETTO	LAGERSATZ JUEGO COJINETES
5	1663158P		1 RING	ANNEAU ANELLO	RING ARO
6	1663163		10 SHIM	CALE REGLAGE SPESSORE	EINSTELLBLECH CALCE
7	Y762260	1/4" X 1-3/4	1 PIN	GOUPILLE PERNO	BOLZEN PASADOR
8	1663159P		1 BALL	BILLE SFERA	KUGEL BOLA
9	1663157P		1 RING	ANNEAU ANELLO	RING ARO
10	70912269	3/8"-16 X 2	8 CAPSCREW	VIS BOUCHON TAPPO A VITE	HUTSCHRAUBE TORNILLO TAPON
11	70923501	5/8"-11 X 3-3/4	1 CAPSCREW	VIS BOUCHON TAPPO A VITE	HUTSCHRAUBE TORNILLO TAPON
12	70926937	5/8"-11	1 NUT	ECROU DADO	MUTTER TUERCA
13	700113646B		1 CLEVIS	CHAPE GANCIO D'ATTACCO	GABELSTUECK GANCHO SEGURI.
14	700720132		1 CHAIN	CHAINE CATENA	KETTE CADENA
15	1663161B		2 PLATE	PLAQUE PIASTRA	PLATTE PLATO
16	1663162B		1 SPACER	ENTRETOISE DISTANZIALE	ABSTANDSTUECK DISCO ESPACIADOR
17	700124041	1"-1/4-7 X 9	1 BOLT	BOULON BULLONE	MASCH.SCHRAUBE ESPIGA/BULON
18	7705197	1"-1/4	2 WASHER	RONDELLE RONDELLA	UNTERLEGSSCHEIBE ARANDELA
19	7704653	1"-1/4-7	1 NUT	ECROU DADO	MUTTER TUERCA
20	704585	1"-1/4-7	1 NUT	ECROU DADO	MUTTER TUERCA
21	700716624	5/8"-11 X 7-1/2	1 BOLT	BOULON BULLONE	MASCH.SCHRAUBE ESPIGA/BULON
22	70917373	5/8"	1 LOCK WASHER	RONDELLE FREIN ROSETTA DENTELL.	FEDERRING ARANDELA GROWER
23	70932665	5/8"-11	1 NUT	ECROU DADO	MUTTER TUERCA
24	70923219	1/4"-28	1 GREASER	GRAISSEUR INGRASSATORE	FETTNIPEL ENGRASADOR
25	700713922		1 PIN	GOUPILLE PERNO	BOLZEN PASADOR
26	700720231	➔ HK 91221	1 JACK	CRIC MARTINETTO	WAGENHEBER GATO

Hitch Safety Chain – Jack
 Chaîne De Securite – Cric
 Sicherheitskette – Abstellstuetze
 Catena Sicurezza – Martinetto
 Cadena Seguridad – Gato Armado

10-5

➔ HP 91100

5-BA39-002-D

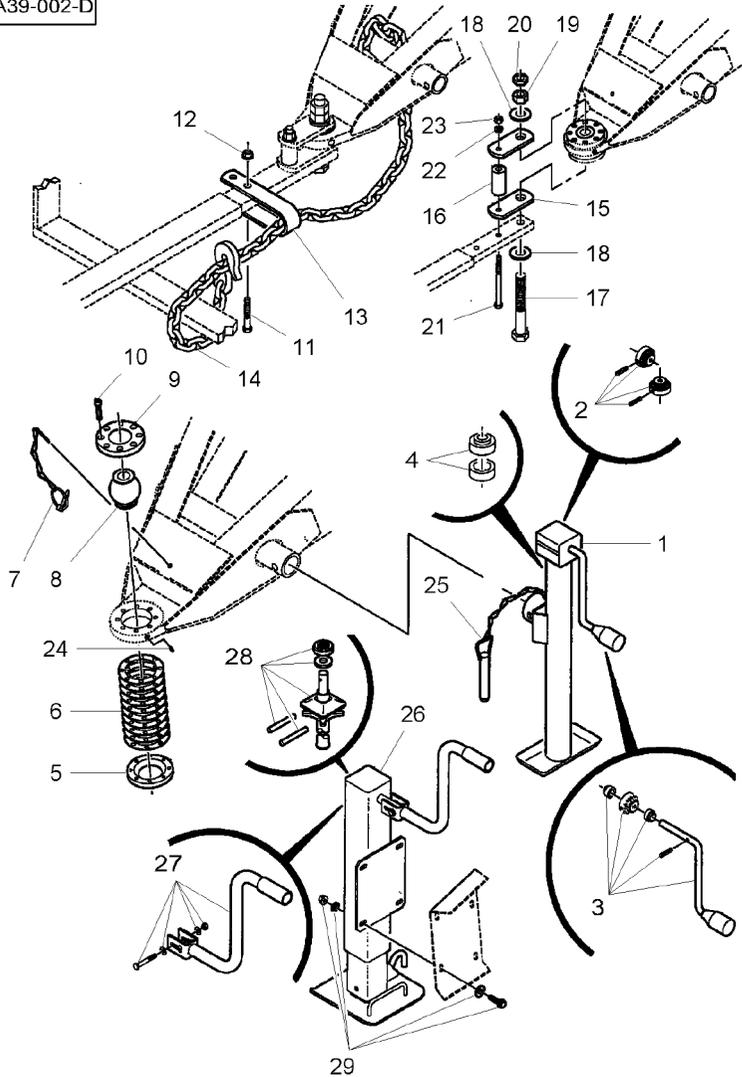

27	700720181	26	1	HANDLE	POIGNEE	HANDGRIFF
					MANIGLIA	MANETA
28	700720180	26	1	KIT, HARDWARE	JEUQUINCAILLERIE	NORMTEILESATZ
					KIT BULLONERIA	BULONERIA JUEGO
29	★7883432	1/2"-13 X 1-3/4	4	SCREW	VIS	SCHRAUBE
29	★457432		4	WASHER	VITE	TORNILLO
29	★705541	1/2"	4	WASHER	RONDELLE	UNTERLEGSCHIEBE
					RONDELLA	ARANDELA
29	★Y704742	1/2"-13	4	LOCKNUT	RONDELLA	UNTERLEGSCHIEBE
					ECROU BLOCAGE	ARANDELA
					AUTOBLOCCANTE	SICHERUNGSMUTTER
						CONTRATUERCA

Hitch Safety Chain – Jack
 Chaîne De Sécurité – Cric
 Sicherheitskette – Abstellstuetze
 Catena Sicurezza – Martinetto
 Cadena Seguridad – Gato Armado

10-10

➔ HP 91101

5-BA39-005-A

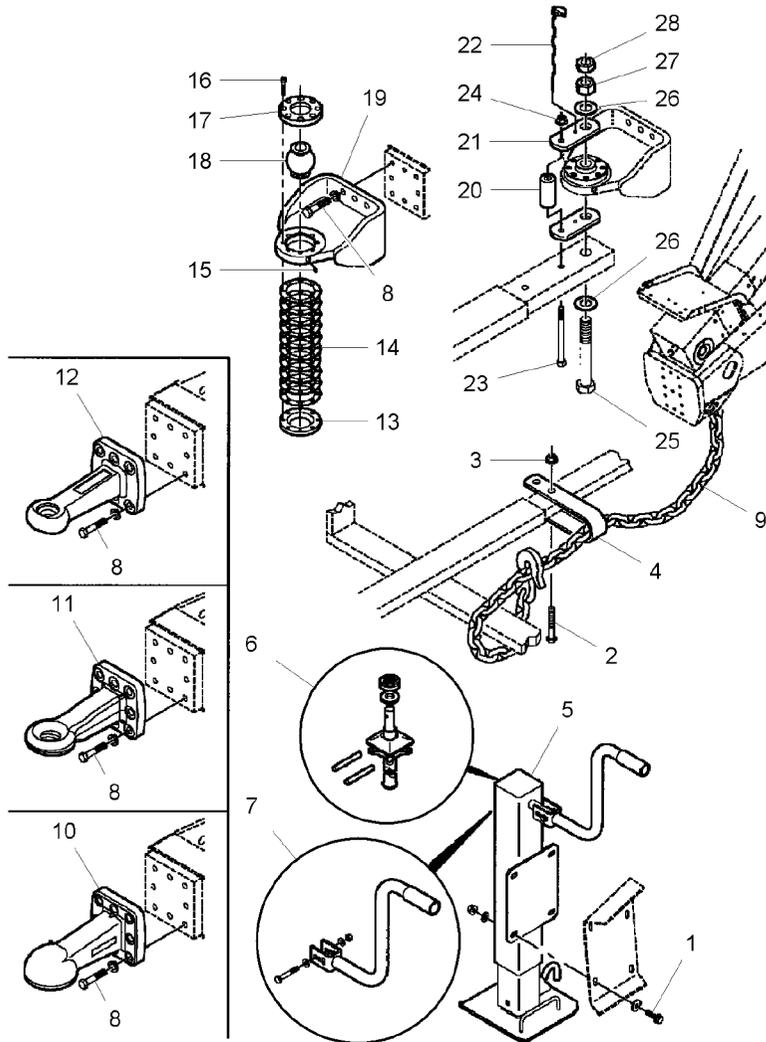

1★7883432	1/2"-13 X 1-3/4	4 SCREW	VIS	SCHRAUBE
1★457432		4 WASHER	VITE	TORNILLO
1★705541	1/2"	4 WASHER	RONDELLE	UNTERLEGSCHIBE
1★Y704742	1/2"-13	4 LOCKNUT	RONDELLE	ARANDELA
2★70923501	5/8"-11 X 3-3/4	1 CAPSCREW	RONDELLE	UNTERLEGSCHIBE
3★70926937	5/8"-11	1 NUT	ECROU BLOCAGE	ARANDELA
4★700113646B		1 CLEVIS	AUTOBLOCCANTE	SICHERUNGSMUTTER
5★700720231		1 JACK	VIS BOUCHON	CONTRATUERCA
6★700720180	5	1 KIT, HARDWARE	TAPPO A VITE	HUTSCHRAUBE
7★700720181	5	1 HANDLE	ECROU BLOCAGE	TORNILLO TAPON
8★7703879	M16 X 60	28 CAPSCREW	DADO	MUTTER
8★700708348	M16	28 LOCKNUT	CHAPE	TUERCA
9★700720132		1 CHAIN	GANCIO D'ATTACCO	GABELSTUECK
10★MK41145		1 KIT, COUPLING	CRIC	GANCHO SEGURI.
10★700721590		1 COUPLING	MARTINETTO	WAGENHEBER
11★MK41144	50 MM	1 KIT, COUPLING	JEU QUINCAILLERIE	GATO
11★700723357	50 MM	1 KIT	KIT BULLONERIA	NORMTEILESATZ
12★MK41143	40 MM	1 KIT, COUPLING	POIGNEE	BULLONERIA JUEGO
12★700721591	40 MM	1 COUPLING	MANIGLIA	HANDGRIFF
13★1663158P	▼	1 RING	VIS BOUCHON	MANETA
14★1663163		10 SHIM	TAPPO A VITE	HUTSCHRAUBE
15★70923219	1/4"-28	1 GREASER	ECROU BLOCAGE	TORNILLO TAPON
16★70912269	3/8"-16 X 2	8 CAPSCREW	AUTOBLOCCANTE	SICHERUNGSMUTTER
17★1663157P	▲	1 RING	CHAINE	CONTRATUERCA
18★1663159P		1 BALL	CATENA	KETTE
19★700164420		1 HITCH	JEU CRABOT	CADENA
			KIT ACCOPIAMENTO	SATZ KUPPL.STCK
			CRABOT	JGO.ACOPLAMIENTO
			INNESTO	KUPPLUNG
			JEU CRABOT	ACOPLAMIENTO
			KIT ACCOPIAMENTO	SATZ KUPPL.STCK
			JEU	JGO.ACOPLAMIENTO
			KIT	SATZ
			JEU CRABOT	JUEGO
			KIT ACCOPIAMENTO	SATZ KUPPL.STCK
			CRABOT	JGO.ACOPLAMIENTO
			INNESTO	KUPPLUNG
			ANNEAU	ACOPLAMIENTO
			ANELLO	RING
			CALE REGLAGE	ARO
			SPESSORE	EINSTELLBLECH
			GRAISSEUR	CALCE
			INGRASSATORE	FETTNIPPEL
			VIS BOUCHON	ENGRASADOR
			TAPPO A VITE	HUTSCHRAUBE
			ANNEAU	TORNILLO TAPON
			ANELLO	RING
			BILLE	ARO
			SFERA	KUGEL
			ATTELAGE	BOLA
			ATTACCO	ANHAENGEKUPPLUNG
				ENGANCHE

Hitch Safety Chain – Jack
 Chaîne De Sécurité – Cric
 Sicherheitskette – Abstellstuetze
 Catena Sicurezza – Martinetto
 Cadena Seguridad – Gato Armado

10-10

➔ HP 91101

5-BA39-005-A

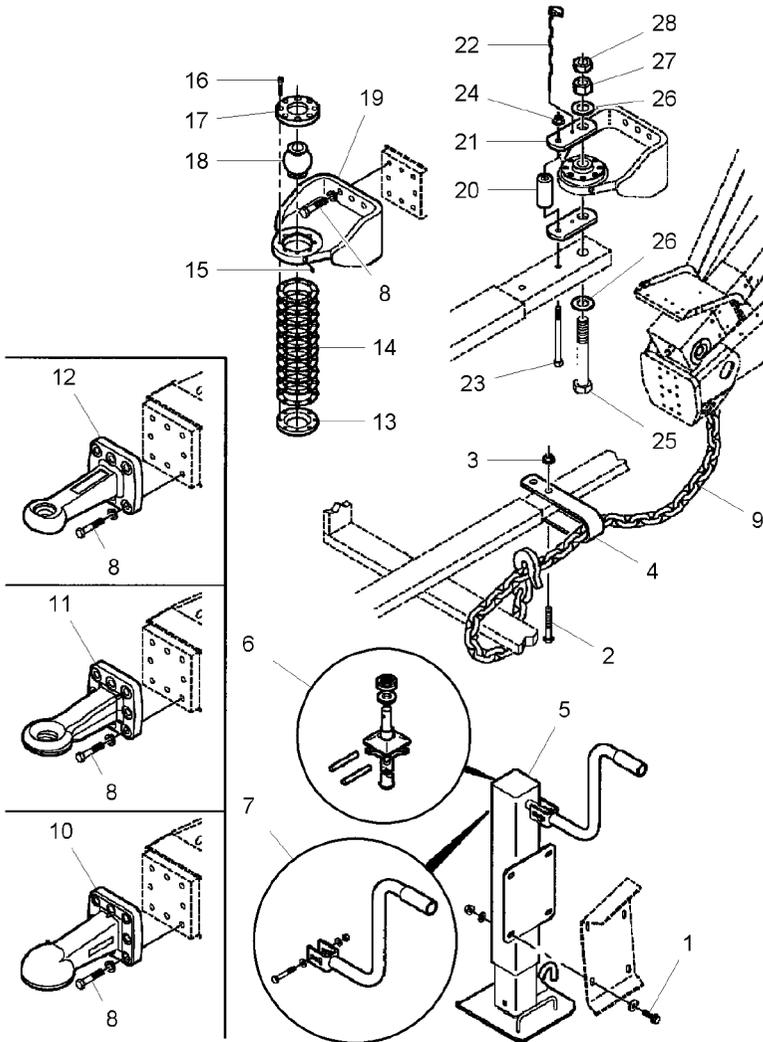

- 20★1663162B
- 21★1663161B
- 22★Y762260
- 23★700716624 5/8"-11 X 7-1/2
- 24★700703922 5/8"-11
- 25★700124041 1"-1/4-7 X 9
- 26★7705197 1"-1/4
- 27★7704653 1"-1/4-7
- 28★704585 1"-1/4-7

- | | | |
|-----------|---------------|------------------|
| 1 SPACER | ENTRETOISE | ABSTANDSTUECK |
| 2 PLATE | DISTANZIALE | DISCO ESPACIADOR |
| 1 PIN | PLAQUE | PLATTE |
| 1 BOLT | PIASTRA | PLATO |
| 1 LOCKNUT | GOUPILLE | BOLZEN |
| 1 BOLT | PERNO | PASADOR |
| 2 WASHER | BOULON | MASCH.SCHRAUBE |
| 1 NUT | BULLONE | ESPIGA/BULON |
| 1 NUT | ECROU BLOCAGE | SICHERUNGSMUTTER |
| | AUTOBLOCCANTE | CONTRATUERCA |
| | BOULON | MASCH.SCHRAUBE |
| | BULLONE | ESPIGA/BULON |
| | RONDELLE | UNTERLEGSCHIEBE |
| | RONDELLA | ARANDELA |
| | ECROU | MUTTER |
| | DADO | TUERCA |
| | ECROU | MUTTER |
| | DADO | TUERCA |

Transmission
Transmission
Getriebe
Transmissione
Transmission

10-15

Flywheel
Volant Moteur
Schwungrad
Volano
Volante Motor

5-BA01-007-D

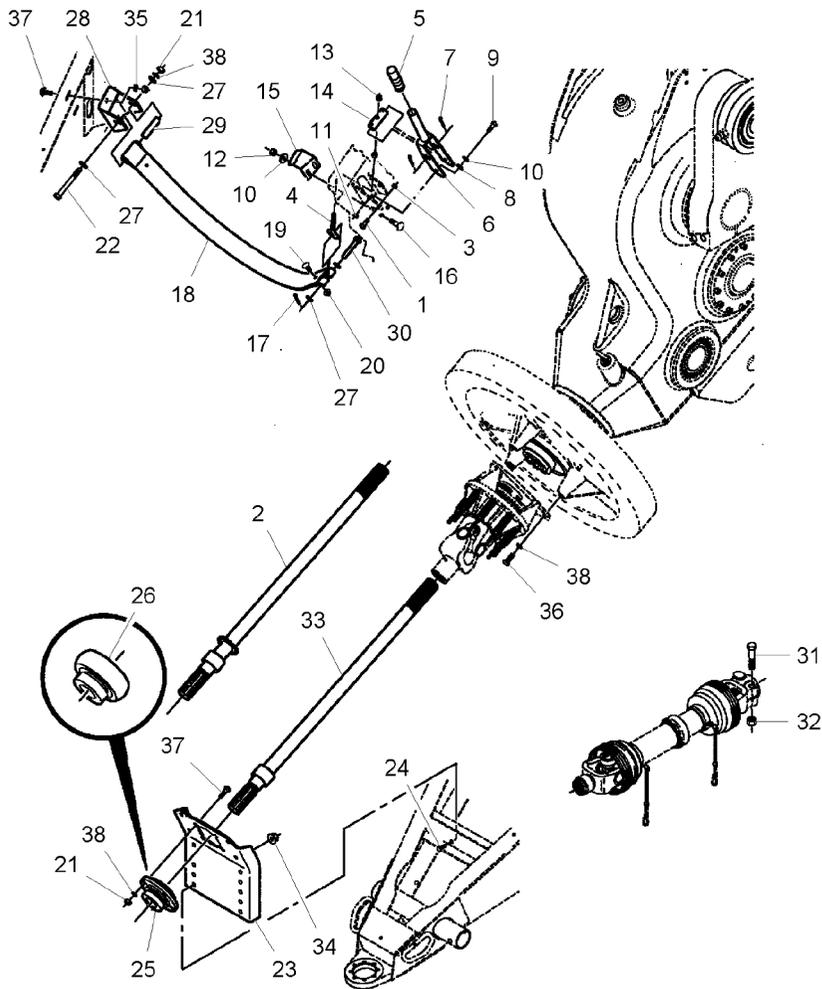

1	★70921332	5/16"-18 X 3/4	1	CAPSCREW	VIS BOUCHON TAPPO A VITE	HUTSCHRAUBE TORNILLO TAPON
2	★700153506P	[AC]	1	SHAFT	ARBRE ALBERO	WELLE ARBOL
2	★700153507P	[BC]	1	SHAFT	ARBRE ALBERO	WELLE ARBOL
3	Y704726	5/16"-18	1	LOCKNUT	ECROU BLOCAGE AUTOBLOCCANTE	SICHERUNGSMUTTER CONTRATUERCA
4	766667	1/2"-13 X 10	1	EYE BOLT	BOULON A OEIL GOLFARE	AUGENSCHRAUBE CANCAMO
5	27342		1	GRIP	MANCHE IMPUGNATURA	GRIFF EMPUNADURA
6	★700113054P		1	HANDLE	POIGNEE MANIGLIA	HANDGRIFF MANETA
7	★932036	3/16" X 1-1/2	2	PIN	GOUILLE PERNO	BOLZEN PASADOR
8	6489231		2	SPACER	ENTRETOISE DISTANZIALE	ABSTANDSTUECK DISCO ESPACIADOR
9	★70921210	3/8"-16 X 1	2	CAPSCREW	VIS BOUCHON TAPPO A VITE	HUTSCHRAUBE TORNILLO TAPON
10	Y705533	3/8"	4	WASHER	RONDELLE RONDELLA	UNTERLEGSCHIEBE ARANDELA
11	Y704734	3/8"-16	2	LOCKNUT	ECROU BLOCAGE AUTOBLOCCANTE	SICHERUNGSMUTTER CONTRATUERCA
12	700711238	3/8"-16	2	LOCKNUT	ECROU BLOCAGE AUTOBLOCCANTE	SICHERUNGSMUTTER CONTRATUERCA
13	7704752	1/2"-13	2	NUT	ECROU DADO	MUTTER TUERCA
14	★700113057		1	PIN	GOUILLE PERNO	BOLZEN PASADOR
15	★700113052P		1	STOP	BUTEE STOP	ANSCHLAG PARO
16	70922786	3/8"-16 X 1	2	BOLT	BOULON BULLONE	MASCH.SCHRAUBE ESPIGA/BULON
17	★62174	5/32" X 1	1	PIN	GOUILLE PERNO	BOLZEN PASADOR
18	★700113058P		1	BRAKE	FREIN FRENO	BREMSE FRENO
19	★706176	18 5/16"-18 X 3/4	2	SCREW	VIS VITE	SCHRAUBE TORNILLO
20	70931277	18 5/16"-18	2	NUT	ECROU DADO	MUTTER TUERCA
21	★704031	1/2"-13	5	NUT	ECROU DADO	MUTTER TUERCA
22	★70923161	1/2"-13 X 4-1/2	1	CAPSCREW	VIS BOUCHON TAPPO A VITE	HUTSCHRAUBE TORNILLO TAPON
23	★700113022		1	SUPPORT	SUPPORT SUPPORTO	LAGERUNG DISPOS.DE SOSTEN
24	700710984	1/2"-13 X 1-1/4	4	SCREW	VIS VITE	SCHRAUBE TORNILLO
25	★700110467P		1	BEARING	COUSSINET CUSCINETTO	LAGER COJINETE

Transmission
 Transmission
 Getriebe
 Transmissions
 Transmission

10-15

Flywheel
 Volant Moteur
 Schwungrad
 Volano
 Volante Motor

5-BA01-007-D

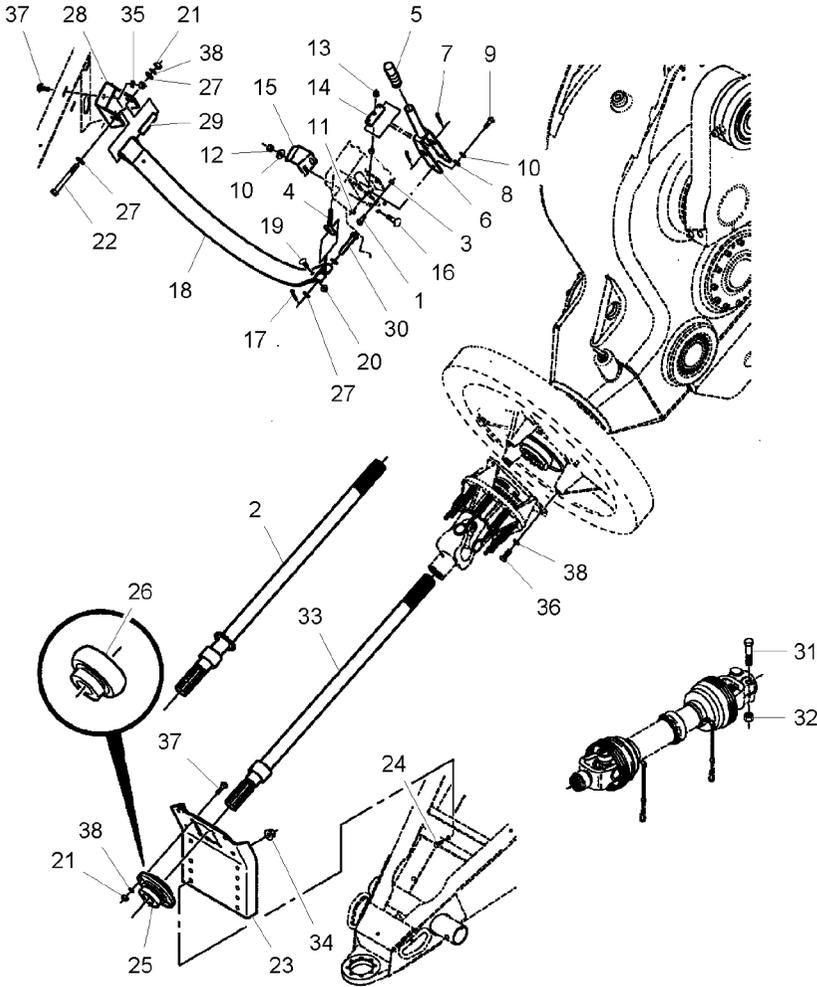

26	51318	25	1	BEARING	COUSSINET	LAGER
27	705541	1/2"	4	WASHER	CUSCINETTO	COJINETE
28	★700112893P	▶	1	CHANNEL	RONDELLA	UNTERLEGSCHIEBE
29	★6524003P		1	SPACER	RONDELLA	ARANDELA
30	63883	1/2" X 3	1	CLEVIS PIN	CANAL	KANAL
31	★700708270	5/8"-11 X 3	1	CAPSCREW	PROFILATO	CANAL
32	700711198	5/8"-11	1	LOCKNUT	ENTRETOISE	ABSTANDSTUECK
33	★700113039P		1	SHAFT	DISTANZIALE	DISCO ESPACIADOR
34	Y704742	1/2"-13	4	LOCKNUT	AXE	SPLINTBOLZEN
35	700714586	1/2"-13	2	NUT	PERNO D'ATTACCO	BULON CILINDRICO
36	★70923154	1/2"-13 X 1-1/2	3	CAPSCREW	VIS BOUCHON	HUTSCHRAUBE
37	★68619	1/2"-13 X 1-1/4	6	BOLT	TAPPO A VITE	TORNILLO TAPON
38	★Y705046	1/2"	8	LOCK WASHER	ECROU BLOCAGE	SICHERUNGSMUTTER
					AUTOBLOCCANTE	CONTRATUERCA
					ARBRE	WELLE
					ALBERO	ARBOL
					ECROU BLOCAGE	SICHERUNGSMUTTER
					AUTOBLOCCANTE	CONTRATUERCA
					ECROU	MUTTER
					DADO	TUERCA
					VIS BOUCHON	HUTSCHRAUBE
					TAPPO A VITE	TORNILLO TAPON
					BOULON	MASCH.SCHRAUBE
					BULLONE	ESPIGA/BULON
					RONDELLA FREIN	FEDERRING
					ROSETTA DENTELL.	ARANDELA GROWER
[A]	USE WITH PTO TYPE 2 UTILISER AVEC PTO TYPE 2 NUR FUER PTO TYP 2 USATO CON PTO TIPO 2 USA CON PTO TIPO 2					
[B]	USE WITH PTO TYPE 3 UTILISER AVEC PTO TYPE 3 NUR FUER PTO TYP 3 USATO CON PTO TIPO 3 USA CON PTO TIPO 3					
[C]	WITH ELECTRONIC CONTROL AVEC CONTROLE ELECTRONIQUE MIT ELEKTRONISCHE STEUERUNG CON CONTROLLO ELETTRONICO CON CONTROL ELECTRONICO					

Transmission
 Transmission
 Getriebe
 Transmissions
 Transmission

10-20

Upper Right Components - Up To 190lb-50100
 Partie Superieure Droite - Jusqu'au 190lb-50100
 Oberer Teil Rechts - Bis 190lb-50100
 Parte Superior Destra - Fino Alla 190lb-50100
 Partido Superior Derecho - Hasta 190lb-50100

5-BA01-008-B

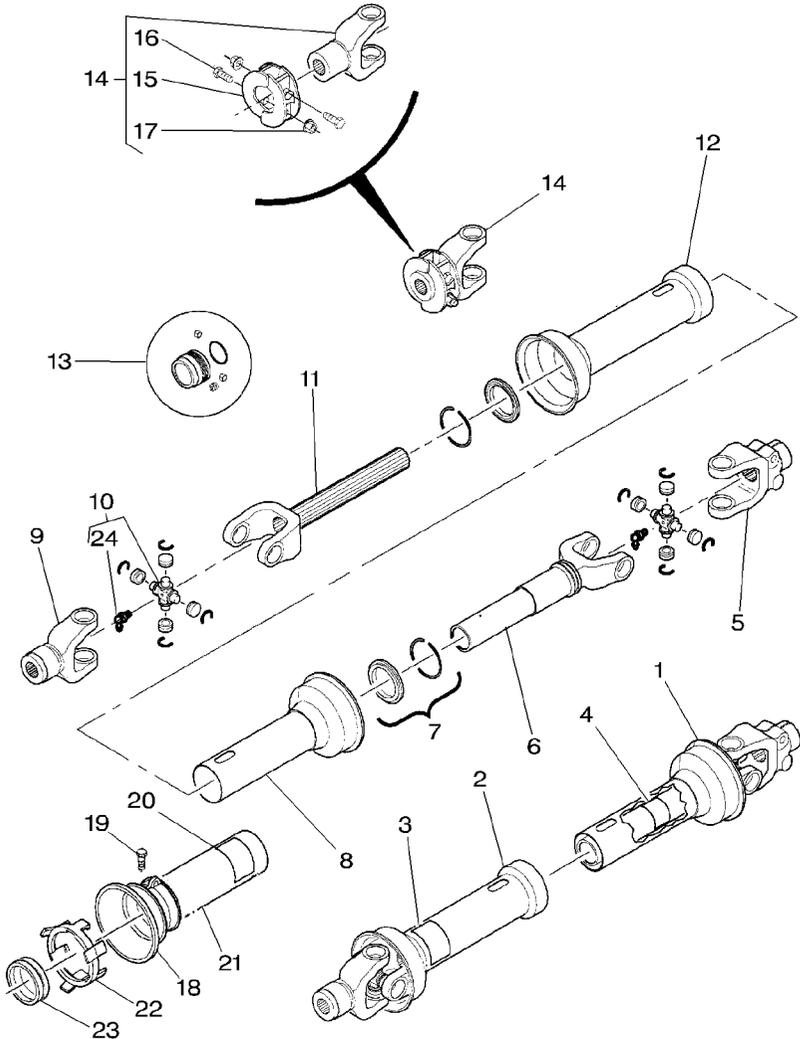

1	700712443		1	UNIVERSAL JOINT	CARDAN	KARDANGELENK
2	700712444		1	UNIVERSAL JOINT	GIUNTO UNIVERSAL	JUNTA UNIVERSAL
3	700707960		1	DECAL	CARDAN	KARDANGELENK
4	210371	DANGER	1	DECAL	GIUNTO UNIVERSAL	JUNTA UNIVERSAL
5	700712517	20	1	YOKE	DECALCOMANIE	AUFKLEBER
6	700712445		1	YOKE	DECALCOMANIA	CALCOMANIA
7	700712579		1	YOKE	DECALCOMANIA	AUFKLEBER
8	700712446		1	YOKE	DECALCOMANIA	CALCOMANIA
9	8802548	21	1	YOKE	CHAPE ARTICULAT	GELENKGABEL
10	7815053		1	YOKE	FORCELLA	YUGO
11	700706966		1	YOKE	CHAPE ARTICULAT	GELENKGABEL
12	700712447		1	YOKE	FORCELLA	YUGO
13	700720122		2	KIT, REPAIR	KIT SERVICE	WARTUNGSSATZ
14	700712474	21	1	SHIELD	KIT DI SERVIZIO	JEUGO, SERVICE
15	700712475	14	1	YOKE	TOLE	SCHILD
16	354655X1	14 1/2"-13 X 3	1	YOKE	RIPARO	BLINDAJE
17	704858	14 1/2"-13	1	YOKE	CHAPE ARTICULAT	GELENKGABEL
18	700050800	[A]	1	YOKE	FORCELLA	YUGO
19	70922784	[A]	2	KIT, REPAIR	TOLE	SCHILD
20	879197	[A]	1	KIT, REPAIR	RIPARO	BLINDAJE
21	700050800	[A]	1	KIT, REPAIR	JEU REPARATION	REPARATURSATZ
22		[AB]	1	KIT, REPAIR	KIT RIPARAZIONE	JUEGO REPARACION
23	3901316M1	[A]	1	KIT, REPAIR	CHAPE ARTICULAT	GELENKGABEL
24	13223X	1/8"-27 X 65°	1	CLAMP	FORCELLA	YUGO
			1	CLAMP	COLLIER	HALTESCHELLE
			2	BOLT UNC	FASCETTA	ABRAZADERA
			2	LOCKNUT	BOULON UNC	MASCH.SCHRB.UNC
			1	PTO GUARD	BULLONE UNC	PERNO UNC
			1	BOLT	ECROU BLOCAGE	SICHERUNGSMUTTER
			1	DECAL	AUTOBLOCCANTE	CONTRATUERCA
			1	PTO GUARD	PTO PROTECTEUR	PTO SCHUTZ
			1	COLLAR	PTO RIPARO	DEFENSA TDF
			1	PLATE	BOULON	MASCH.SCHRAUBE
			2	NIPPLE	BULLONE	ESPIGA/BULON
					DECALCOMANIE	AUFKLEBER
					DECALCOMANIA	CALCOMANIA
					PTO PROTECTEUR	PTO SCHUTZ
					PTO RIPARO	DEFENSA TDF
					COLLERETTE	KRAGEN
					COLLARE	COLLARIN
					PLAQUE	PLATTE
					PIASTRA	PLATO
					GRAISSEUR COUDE	NIPPEL
					NIPPLIO	NIPLE

Transmission
Transmission
Getriebe
Transmissione
Transmission

10-20

Upper Right Components - Up To 190lb-50100
Partie Superieure Droite - Jusqu'au 190lb-50100
Oberer Teil Rechts - Bis 190lb-50100
Parte Superior Destra - Fino Alla 190lb-50100
Partido Superior Derecho - Hasta 190lb-50100

5-BA01-008-B

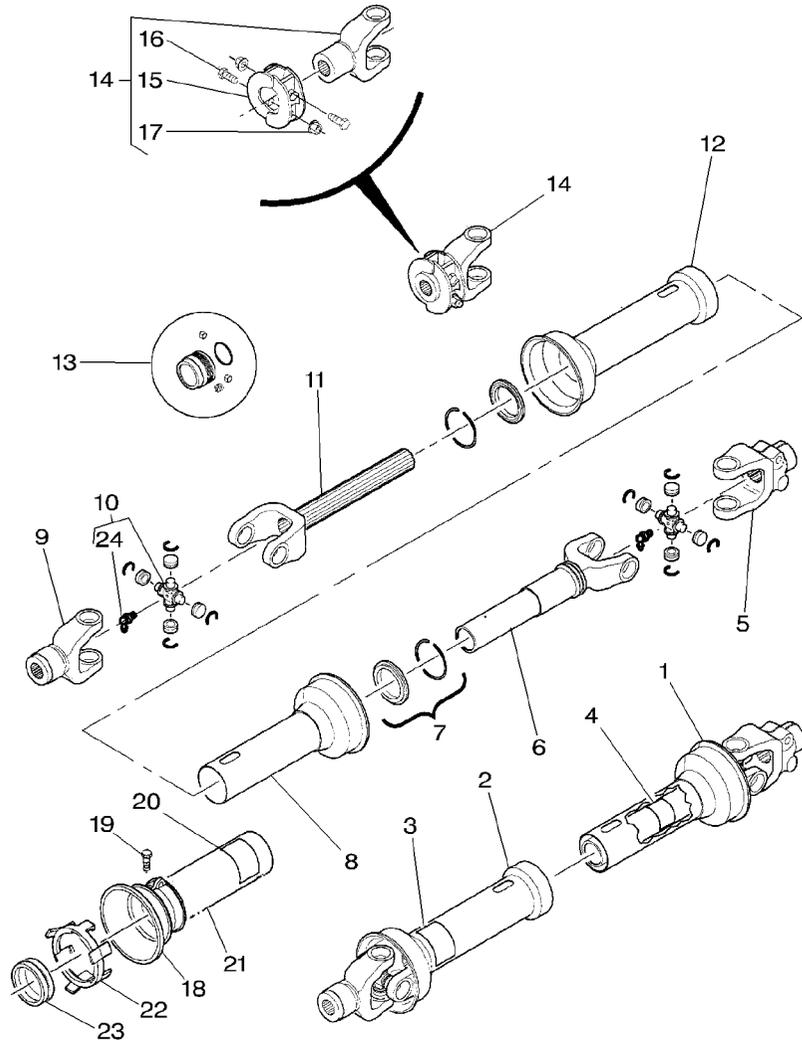

[A] EUROPE ONLY
EUROPE SEULEMENT
NUR FUER EUROPA
SOLO EUROPA
EUROPA SOLAMENTE

[B] NOT SUPPLIED
NON FOURNI
NICHT MITGELIEFERT
NON SERVITO
NO SUMINISTRADO

Transmission
 Transmission
 Getriebe
 Transmissions
 Transmission

10-25

Upper Right Components - Up To 190lb-50100
 Partie Superieure Droite - Jusqu'au 190lb-50100
 Oberer Teil Rechts - Bis 190lb-50100
 Parte Superior Destra - Fino Alla 190lb-50100
 Partido Superior Derecho - Hasta 190lb-50100

5-BA01-009-B

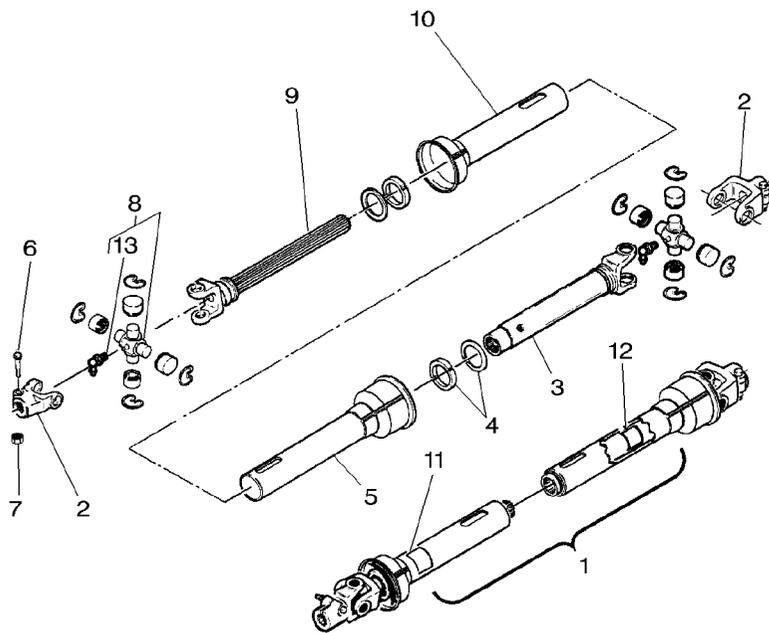

1	700720062	●○ 700706449	1	UNIVERSAL JOINT	CARDAN	KARDANGELENK
2	700712517	▲ 20	2	YOKE	GIUNTO UNIVERSAL	JUNTA UNIVERSAL
3	8802621		1	YOKE	CHAPE ARTICULAT	GELENKGABEL
4	700712579		2	KIT, SERVICE	FORCELLA	YUGO
5	700706953		1	SHIELD	CHAPE ARTICULAT	GELENKGABEL
6	354289X1	5/8"-11 X 3	2	BOLT UNC	FORCELLA	YUGO
7	70926937	5/8"-11	2	NUT	KIT SERVICE	WARTUNGSSATZ
8	7815053		2	KIT, REPAIR	KIT DI SERVIZIO	JEUGO, SERVICE
9	8802613		1	SHAFT	TOLE	SCHILD
10	700706954		2	BOLT UNC	RIPARO	BLINDAJE
11	700707960		1	DECAL	BOULON UNC	MASCH.SCHRB.UNC
12	210371	DANGER	1	DECAL	BULLONE UNC	PERNO UNC
13	13223X	1/8"-27 X 65°	2	NIPPLE	ECROU	MUTTER
					DADO	TUERCA
					JEU REPARATION	REPARATURSATZ
					KIT RIPARAZIONE	JUEGO REPARACION
					ARBRE	WELLE
					ALBERO	ARBOL
					TOLE	SCHILD
					RIPARO	BLINDAJE
					DECALCOMANIE	AUFKLEBER
					DECALCOMANIA	CALCOMANIA
					DECALCOMANIE	AUFKLEBER
					DECALCOMANIA	CALCOMANIA
					GRAISSEUR COUDE	NIPPEL
					NIPPLIO	NIPLE

Transmission
Transmission
Getriebe
Transmissione
Transmission

10-30

Type 2 1-3/8 X 21 - From 190lb-50101
Type 2 1-3/8 X 21 - A Partir Du 190lb-50101
Type 2 1-3/8 X 21 - Ab Den 190lb-50101
Type 2 1-3/8 X 21 - Dalla 190lb-50101
Type 2 1-3/8 X 21 - A Partir Del 190lb-50101

5-BA01-025-C

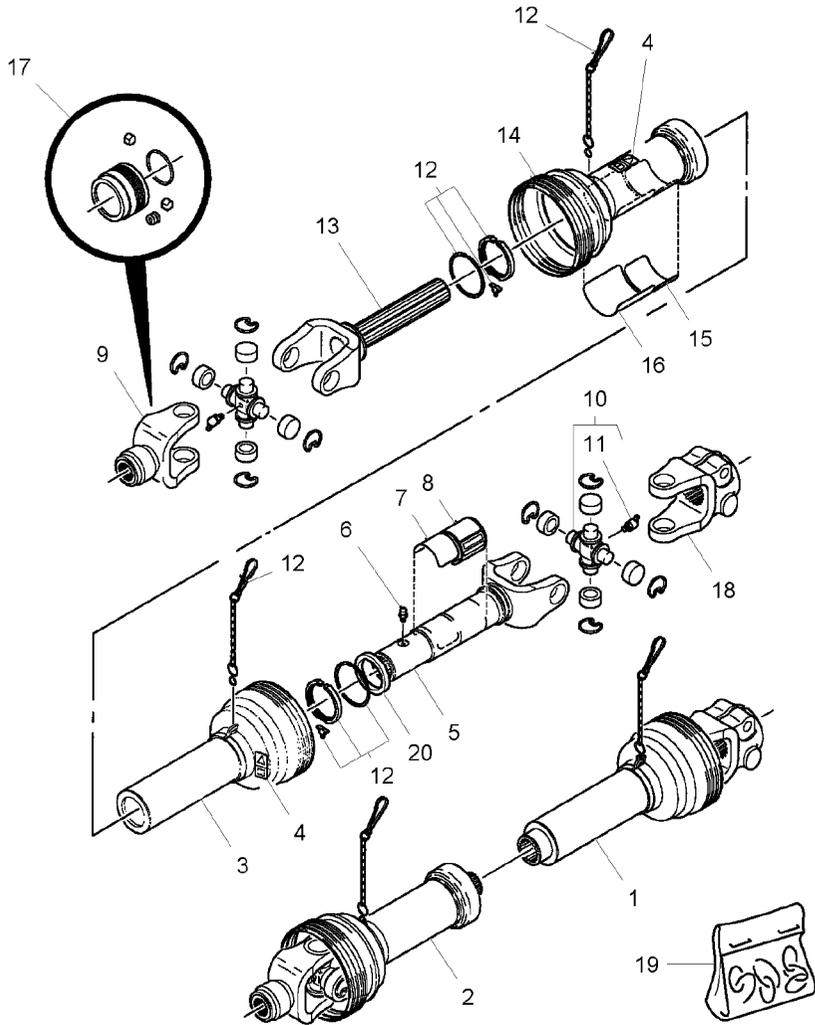

1	700715020	[B]	1	SHAFT	ARBRE ALBERO	WELLE ARBOL
2	700720121	[C]	1	UNIVERSAL JOINT	CARDAN GIUNTO UNIVERSAL	KARDANGELENK JUNTA UNIVERSAL
3	700715024		1	SHIELD	TOLE RIPARO	SCHILD BLINDAJE
4	700715035	➔	2	DECAL	DECALCOMANIE DECALCOMANIA	AUFKLEBER CALCOMANIA
5	700712445		1	YOKE	CHAPE ARTICULAT FORCELLA	GELENKGABEL YUGO
6	700712767	3/16"	1	GREASER	GRAISSEUR INGRASSATORE	FETTNIPPEL ENGRASADOR
7		[A]	1	DECAL	DECALCOMANIE DECALCOMANIA	AUFKLEBER CALCOMANIA
8	210371		1	DECAL	DECALCOMANIE DECALCOMANIA	AUFKLEBER CALCOMANIA
9	8802548	➔ 190LB-50194 ⊘ 21 ⊘ 1"-3/8	1	YOKE	CHAPE ARTICULAT FORCELLA	GELENKGABEL YUGO
9	700720112	➔ 190LB-50195 ⊘ 21 ⊘ 1"-3/8	1	YOKE	CHAPE ARTICULAT FORCELLA	GELENKGABEL YUGO
9	W102-5506	⊘ 6	1	YOKE	CHAPE ARTICULAT FORCELLA	GELENKGABEL YUGO
10	7815053		2	KIT, REPAIR	JEU REPARATION KIT RIPARAZIONE	REPARATURSATZ JUEGO REPARACION
11	70915275	10 1/8"-27 X 65°	2	GREASER	GRAISSEUR INGRASSATORE	FETTNIPPEL ENGRASADOR
12	700720153		1	KIT, BEARING	JEU COUSSINETS KIT CUSCINETTO	LAGERSATZ JUEGO COJINETES
13	700706966		1	YOKE	CHAPE ARTICULAT FORCELLA	GELENKGABEL YUGO
14	700720230		1	SHIELD	TOLE RIPARO	SCHILD BLINDAJE
15		[A]	1	DECAL	DECALCOMANIE DECALCOMANIA	AUFKLEBER CALCOMANIA
16	700707960		1	DECAL	DECALCOMANIE DECALCOMANIA	AUFKLEBER CALCOMANIA
17	700710928	➔ 190LB-50194	1	KIT, REPAIR	JEU REPARATION KIT RIPARAZIONE	REPARATURSATZ JUEGO REPARACION
17	700720122	➔ 190LB-50195	1	KIT, REPAIR	JEU REPARATION KIT RIPARAZIONE	REPARATURSATZ JUEGO REPARACION
18	700712517	⊘ 20 ⊘ 1"-3/4	1	YOKE	CHAPE ARTICULAT FORCELLA	GELENKGABEL YUGO
19	700721800	➔ 700715022	2	KIT, REPAIR	JEU REPARATION KIT RIPARAZIONE	REPARATURSATZ JUEGO REPARACION
20	700715820		1	RING	ANNEAU ANELLO	RING ARO

Transmission
 Transmission
 Getriebe
 Transmissions
 Transmission

10-30

Type 2 1-3/8 X 21 - From 190lb-50101
 Type 2 1-3/8 X 21 - A Partir Du 190lb-50101
 Type 2 1-3/8 X 21 - Ab Den 190lb-50101
 Type 2 1-3/8 X 21 - Dalla 190lb-50101
 Type 2 1-3/8 X 21 - A Partir Del 190lb-50101

5-BA01-025-C

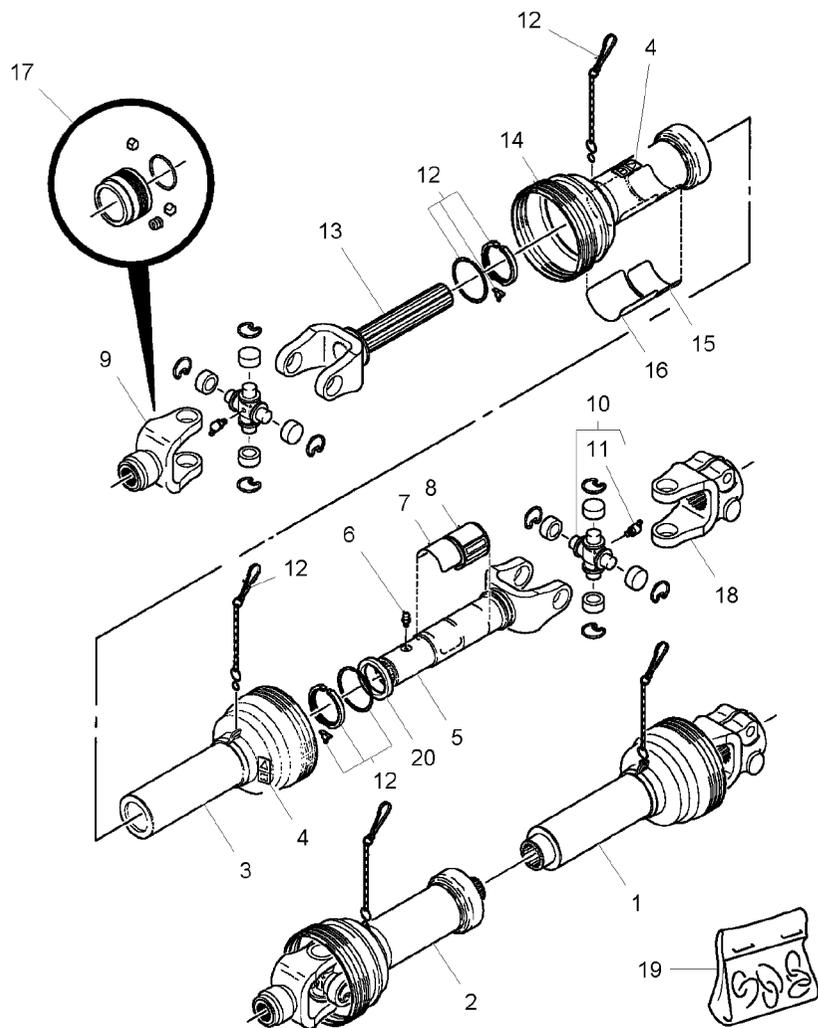

- [A] NOT SERVICED
 PAS FOURNI
 NICHT LIEFERBAR
 NON FORNITO
 NO SUMINISTRADA
- [B] IMPLEMENT SIDE
 COTE OUTILS
 WERKZEUG SEITE
 LATO ATTREZZO
 LADO IMPLEMENTO
- [C] TRACTOR SIDE
 COTE TRACTEUR
 SCHLEPPER SEITE
 LATO TRATTORE
 LADO TRACTOR

Transmission
 Transmission
 Getriebe
 Transmissions
 Transmission

10-35

Type 3 1-3/4 X 20 - From 190lb-50101
 Type 3 1-3/4 X 20 - A Partir Du 190lb-50101
 Type 3 1-3/4 X 20 - Ab Den 190lb-50101
 Type 3 1-3/4 X 20 - Dalla 190lb-50101
 Type 3 1-3/4 X 20 - A Partir Del 190lb-50101

5-BA01-026-C

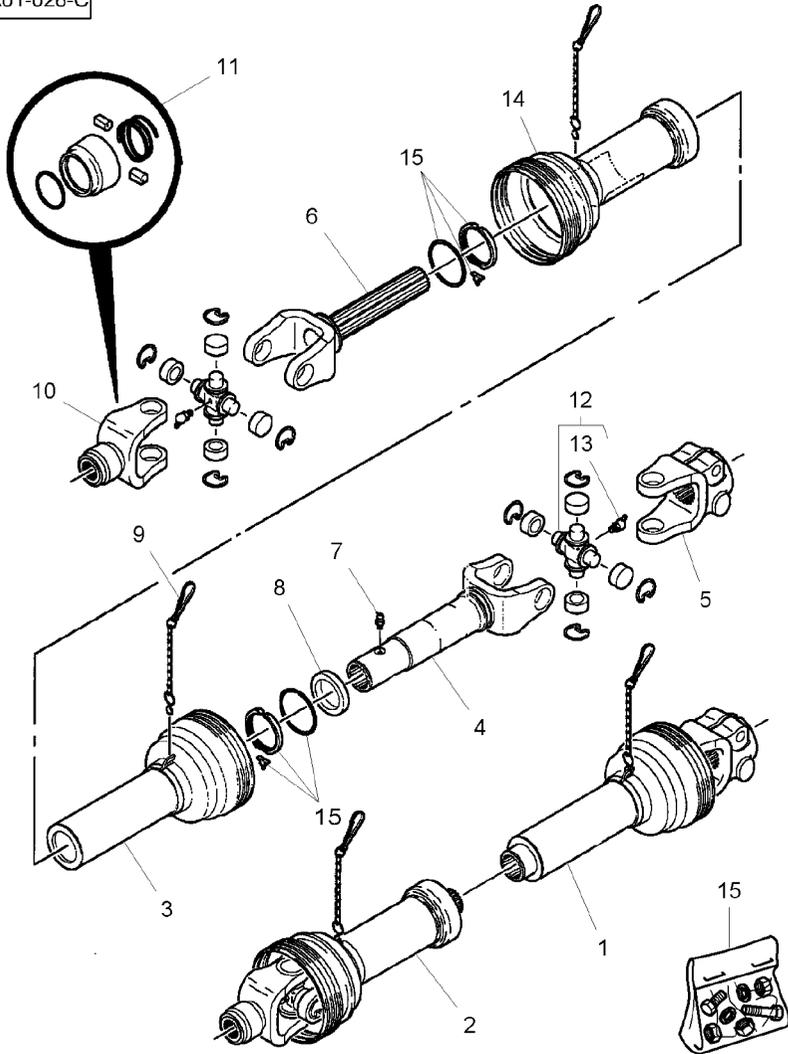

1	700715824	[A]	1	UNIVERSAL JOINT	CARDAN	KARDANGELENK
2	700720111	[B]	1	UNIVERSAL JOINT	GIUNTO UNIVERSAL	JUNTA UNIVERSAL
3	700715826		1	GUARD	CARDAN	KARDANGELENK
4	700715827		1	YOKE	GIUNTO UNIVERSAL	JUNTA UNIVERSAL
5	700712517		1	YOKE	GARDE	SCHUTZVORR
6	8802613		1	SHAFT	PROTEZIONE	DEFENSA
7	700712767	3/16"	1	GREASER	CHAPE ARTICULAT	GELENKGABEL
8	700715820		1	RING	FORCELLA	YUGO
9	700720152		1	YOKE	CHAPE ARTICULAT	GELENKGABEL
10	700720113		1	YOKE	FORCELLA	YUGO
11	★700711425	10	1	KIT	ARBRE	WELLE
12	7815053		2	KIT, REPAIR	ALBERO	ARBOL
13	★70915275	12 1/8"-27 X 65°	2	GREASER	INGRASSATORE	FETTNIPPEL
14	700715825		1	GUARD	ANNEAU	ENGRASADOR
15	700720153		1	KIT, BEARING	ANELLO	RING
					JEU CHAINES	ARO
					KIT CATENA	KETTENSATZ
					CHAPE ARTICULAT	CADENA JUEGO
					FORCELLA	GELENKGABEL
					JEU	YUGO
					KIT	SATZ
					JEU REPARATION	JUEGO
					KIT RIPARAZIONE	REPARATURSATZ
					GRAISSEUR	JUEGO REPARACION
					INGRASSATORE	FETTNIPPEL
					GARDE	ENGRASADOR
					PROTEZIONE	SCHUTZVORR
					JEU COUSSINETS	DEFENSA
					KIT CUSCINETTO	LAGERSATZ
						JUEGO COJINETES

[A] IMPLEMENT SIDE
 COTE OUTILS
 WERKZEUG SEITE
 LATO ATTREZZO
 LADO IMPLEMENTO

[B] TRACTOR SIDE
 COTE TRACTEUR
 SCHLEPPER SEITE
 LATO TRATTORE
 LADO TRACTOR

Clutch
Embrayage
Kupplung
Frizione
Embraque

10-40

5-BA18-004-D

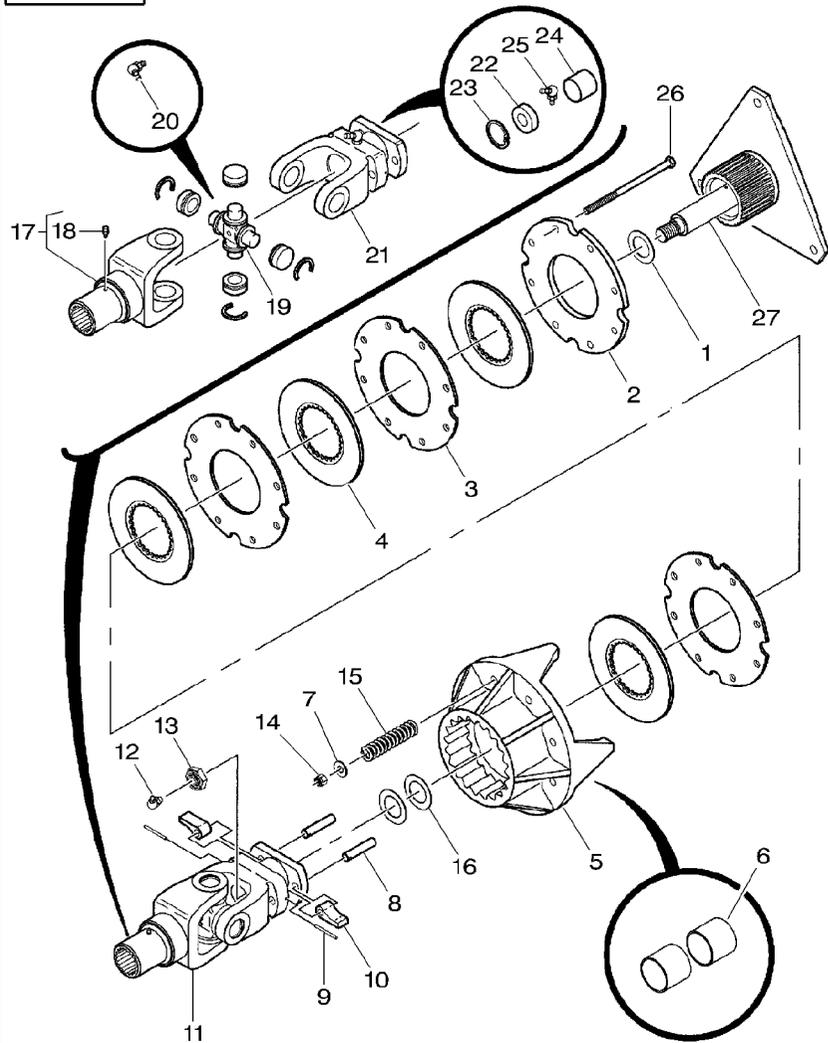

1	Y52274	1"-3/8 X 14	1 BUSH	BAGUE	BUCHSE
2	★6522866P		1 PLATE	BOCCOLA	CASQUILLO
3	700112903P		3 PLATE	PLAQUE	PLATTE
4	700108820		4 DISC	PIASTRA	PLATO
5	★700164637		1 HOUSING	PIASTRA	PLATTE
6	7852114	5	2 BUSH	DISQUE	PLATO
7	355619X1	3/8"	8 WASHER	DISCO	SCHEIBE
8	700113037		2 PIN	CARTER	DISCO
9	70915751	3/16" X 1-1/2	2 PIN	CARCASSA	GEHAEUSE
10	700113036		2 PAWL	BAGUE	ALOJAMIENTO
11	700706087		1 UNIVERSAL JOINT	BOCCOLA	BUCHSE
12	70915276	1/8"-27 X 90°	1 NIPPLE	RONDELLE	CASQUILLO
13	★700707250	7/8"-14	1 NUT	RONDELLA	UNTERLEGSCHIEBE
14	366573X1	3/8"-16	8 LOCKNUT	GOUPILLE	ARANDELA
15	858019		8 COMP.SPONG	PERNO	BOLZEN
16	★6522932		2 SHIM <td>GOUPILLE</td> <td>PASADOR</td>	GOUPILLE	PASADOR
17	700706957	11	1 YOKE	PERNO	BOLZEN
18	70914465	17 1/8"-27	1 GREASE NIPPLE	LINGUET	PASADOR
19	7815053	11	1 KIT, REPAIR	ARRESTO	PASADOR
20	★70915275	19 1/8"-27 X 65°	1 GREASER	CARDAN	SPERRKLINKE
21	700706955	11	1 YOKE	GIUNTO UNIVERSAL	FIADOR TRINQUETE
22	1124697	21	1 BEARING	GRAISSEUR COUDE	KARDANGELLENK
23	70927699	21	1 SNAPRING	NIPPLO	JUNTA UNIVERSAL
24	700706956	21	1 BEARING	ECROU	NIPPEL
25	★70915275	21 1/8"-27 X 65°	1 GREASER	DADO	NIPLE
26	700707998	3/8"-16 X 7	8 CAPSCREW	ECROU BLOCAGE	MUTTER
				AUTOBLOCCANTE	TUERCA
				RESSORT DE COMPR	SICHERUNGSMUTTER
				MOLLA COMPOSTA	CONTRATUERCA
				CALE REGLAGE	DRUCKFEDER
				SPESSORE	RESORTE DE COMP.
				CHAPE ARTICULAT	EINSTELLBLECH
				FORCELLA	CALCE
				GRAISSEUR DROIT	GELENKGABEL
				INGRASSAT.	YUGO
				JEU REPARATION	FETT-NIPPEL
				KIT RIPARAZIONE	ENGRASADOR
				GRAISSEUR	REPARATURSATZ
				INGRASSATORE	JUEGO REPARACION
				CHAPE ARTICULAT	FETTNIPEL
				FORCELLA	ENGRASADOR
				COUSSINET	GELENKGABEL
				CUSCINETTO	YUGO
				SEGMENT ARRET	LAGER
				ANELLO SIEGER	COJINETE
				COUSSINET	SPRENGRING
				CUSCINETTO	ANILLA RETENCION
				GRAISSEUR	LAGER
				INGRASSATORE	COJINETE
				VIS BOUCHON	FETTNIPEL
				TAPPO A VITE	ENGRASADOR
					HUTSCHRAUBE
					TORNILLO TAPON

Clutch
Embrayage
Kupplung
Frizione
Embraque

10-40

5-BA18-004-D

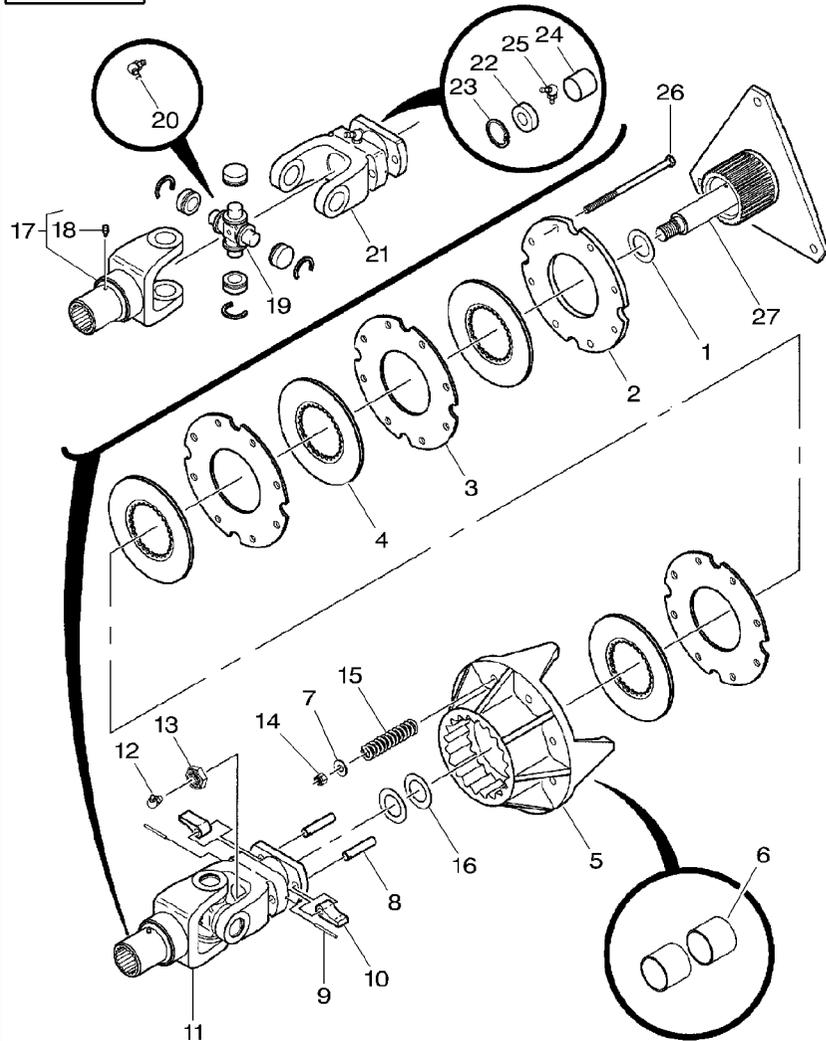

26 ★ 70917378

3/8"

8 FLAT WASHERS

RONDELLES PLATES
RONDELLE PIANA

UNTERLEGSCHIEBEN
ARANDELAS PLANAS

26 ★ 70919439

3/8"-16

8 NUT

ECROU
DADO

MUTTER
TUERCA

27 ★ 700163293

1 SHAFT

ARBRE
ALBERO

WELLE
ARBOL

Transmission
 Transmission
 Getriebe
 Transmissions
 Transmission

10-45

Flywheel
 Volant Moteur
 Schwungrad
 Volano
 Volante Motor

5-BA01-010-D

19 700708348

➡ 190LB-50146
 M16

1 LOCKNUT

ECROU BLOCAGE
 AUTOBLOCCANTE

SICHERUNGSMUTTER
 CONTRATUERCA

19 700711165

➡ 190LB-50147
 5/8"

1 WASHER

RONDELLE
 RONDELLA

UNTERLEGSCHIEBE
 ARANDELA

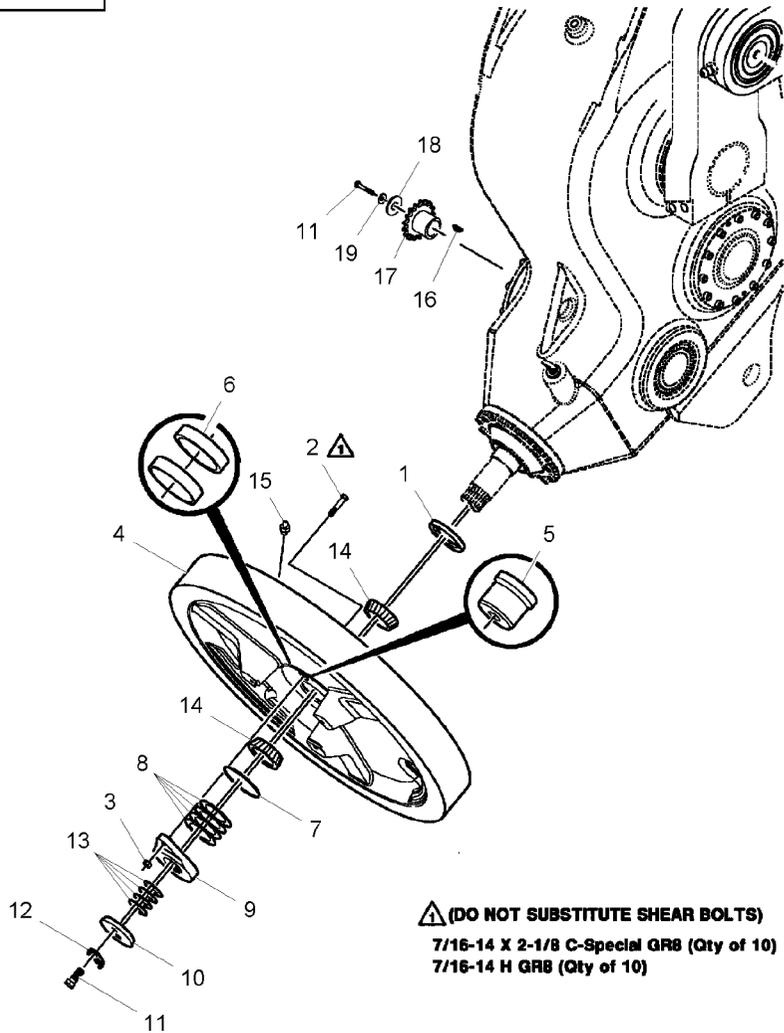

⚠ (DO NOT SUBSTITUTE SHEAR BOLTS)
 7/16-14 X 2-1/8 C-Special GR8 (Qty of 10)
 7/16-14 H GR8 (Qty of 10)

Gearbox
Boîte De Vitesses
Getriebe
Cambio Di Velocità
Caja De Cambios

10-50

5-BA19-005-C

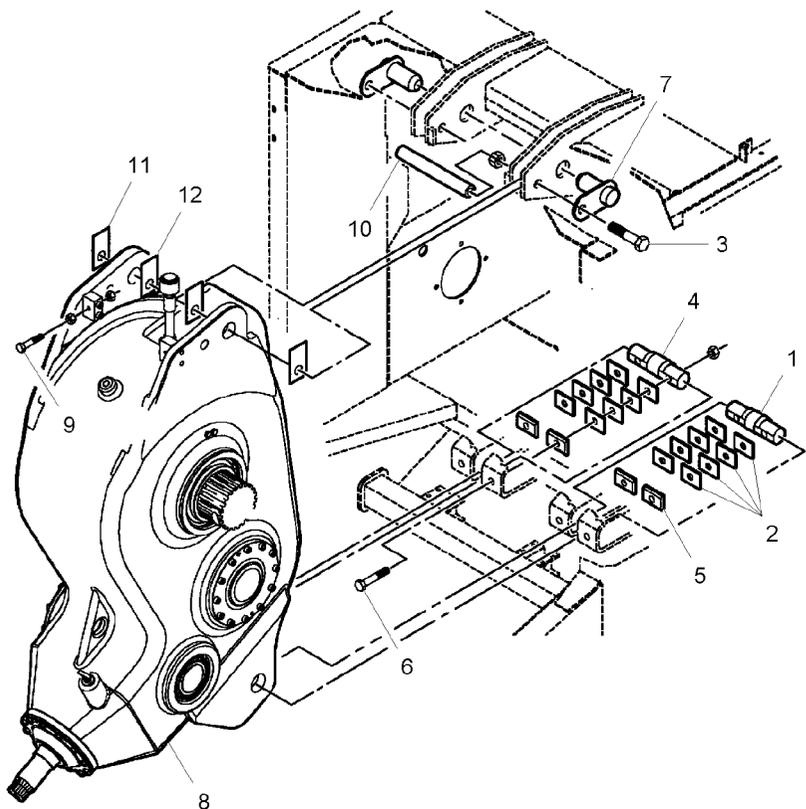

1	700122647		1	PIN	GOUPILLE	BOLZEN
2	700706062	⌵ 0.08/.003	3	SHIM	PERNO	PASADOR
2	700706063	⌵ 0.13/.005			CALE REGLAGE	EINSTELLBLECH
2	700706064	⌵ 0.25/.010	6	SHIM	SPESSORE	CALCE
3	700710263	1"-8 X 4-1/2	6	SHIM	CALE REGLAGE	EINSTELLBLECH
3*	700710264	1"-8	6	SHIM	SPESSORE	CALCE
4	700122650		2	BOLT	BOULON	MASCH.SCHRAUBE
5	700113042P		2	LOCKNUT	BULLONE	ESPIGA/BULON
6*	70925387	3/4"-10 X 4	2	LOCKNUT	ECROU BLOCAGE	SICHERUNGSMUTTER
6*	Y704718	3/4"-10	1	PIN	AUTOBLOCCANTE	CONTRATUERCA
7	700113047P		4	SPACER	GOUPILLE	BOLZEN
8	700122641	➔ 190LB-50186	PERNO	PASADOR		
8	700715980	⊖ 10-65 No 0	4	CAPSCREW	ENTRETOISE	ABSTANDSTUECK
8*	700722210	⊖ 10-70 No 0	4	CAPSCREW	DISTANZIALE	DISCO ESPACIADOR
9	7771504	➔ 190LB-50187	4	CAPSCREW	VIS BOUCHON	HUTSCHRAUBE
9*	70932665	➔ HN 91150	4	LOCKNUT	TAPPO A VITE	TORNILLO TAPON
10	700122646P	⊖ 10-75 No 0	2	PIN	ECROU BLOCAGE	SICHERUNGSMUTTER
11	700122653	⌵ 0,86 mm	1	GEARBOX	AUTOBLOCCANTE	CONTRATUERCA
12	700122654	⌵ 1,80 mm	1	GEARBOX	GOUPILLE	BOLZEN
			1	GEARBOX	PERNO	PASADOR
			1	GEARBOX	BOITE VITESSES	ZAHNRADGETRIEBE
			1	GEARBOX	SCATOLA CAMBIO	CAJA CAMBIO
			1	GEARBOX	BOITE VITESSES	ZAHNRADGETRIEBE
			1	GEARBOX	SCATOLA CAMBIO	CAJA CAMBIO
			1	GEARBOX	BOITE VITESSES	ZAHNRADGETRIEBE
			1	GEARBOX	SCATOLA CAMBIO	CAJA CAMBIO
			2	CAPSCREW	VIS BOUCHON	HUTSCHRAUBE
			4	NUT	TAPPO A VITE	TORNILLO TAPON
			4	NUT	ECROU	MUTTER
			1	TUBE	DADO	TUERCA
			6	SHIM	TUBE	ROHR
			4	SHIM	TUBO	TUBO
					CALE REGLAGE	EINSTELLBLECH
					SPESSORE	CALCE
					CALE REGLAGE	EINSTELLBLECH
					SPESSORE	CALCE

Gearbox
Boîte De Vitesses
Getriebe
Cambio Di Velocità
Caja De Cambios

10-55

Crankshaft - Up To 190lb-50186
Vilebrequin - Jusqu'au 190lb-50186
Kurbelwelle - Bis 190lb-50186
Albero A Gomito - Fino Alla 190lb-50186
Ciguenal - Hasta 190lb-50186

5-BA19-006-B

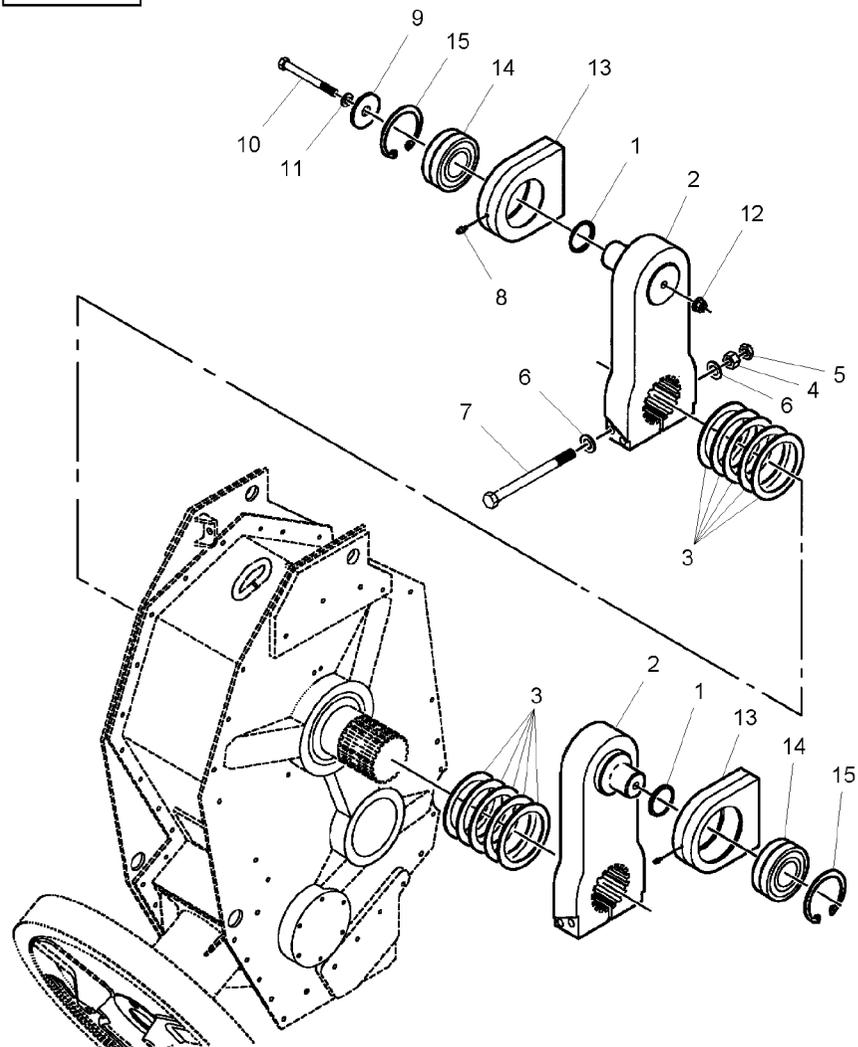

1	700113046		2	SPACER	ENTRETOISE	ABSTANDSTUECK
2	700113023P		2	ARM	DISTANZIALE	DISCO ESPACIADOR
3	700708038	⌘ 0.25/.010	3	SHIM	BRAS	ARM
3	700708039	⌘ 0.64/.025	2	SHIM	BRACCIO	BRAZO
3	700708041	⌘ 1.27/.050	3	SHIM	CALE REGLAGE	EINSTELLBLECH
4	700710264	➡ 190LB-50100	2	SHIM	SPESSORE	CALCE
4	7774292	➡ 190LB-50101	5	SHIM	CALE REGLAGE	EINSTELLBLECH
5	Y704684	1"-8	4	LOCKNUT	SPESSORE	CALCE
6	2700076	1"	4	LOCKNUT	CALE REGLAGE	EINSTELLBLECH
7	700707996	1"-8 X 12	4	NUT	SPESSORE	CALCE
8	70923219	1/4"-28	4	NUT	ECROU BLOCAGE	SICHERUNGSMUTTER
9	6579106P		4	NUT	AUTOBLOCCANTE	CONTRATUERCA
10	70936419	3/4"-10 X 7-1/2	8	WASHER	ECROU	MUTTER
11	Y705566	3/4"	4	WASHER	DADO	TUERCA
12	700710072	3/4"-10	4	WASHER	ECROU	MUTTER
13	700113065		4	BOLT	DADO	TUERCA
14	8050593		4	BOLT	RONDELLE	UNTERLEGSCHIEBE
15	8052144		2	GREASER	RONDELLA	ARANDELA
			1	CAP	BOULON	MASCH.SCHRAUBE
			1	CAPSCREW	BULLONE	ESPIGA/BULON
			1	WASHER	GRAISSEUR	FETTNIPPEL
			1	WASHER	INGRASSATORE	ENGRASADOR
			1	WASHER	CHAPEAU	KAPPE
			1	WASHER	CAPUCHON	TAPA
			1	NUT	VIS BOUCHON	HUTSCHRAUBE
			2	HOUSING	TAPPO A VITE	TORNILLO TAPON
			2	BEARING	RONDELLE	UNTERLEGSCHIEBE
			2	RING	RONDELLA	ARANDELA
					ECROU	MUTTER
					DADO	TUERCA
					CARTER	GEHAEUSE
					CARCASSA	ALOJAMIENTO
					COUSSINET	LAGER
					CUSCINETTO	COJINETE
					ANNEAU	RING
					ANELLO	ARO

Gearbox
Boîte De Vitesses
Getriebe
Cambio Di Velocità
Caja De Cambios

10-60

Crankshaft - From 190lb-50187
Vilebrequin - A Partir Du 190lb-50187
Kurbelwelle - Ab Den 190lb-50187
Albero A Gomito - Dalla 190lb-50187
Ciguenal - A Partir Del 190lb-50187

5-BA19-017-B

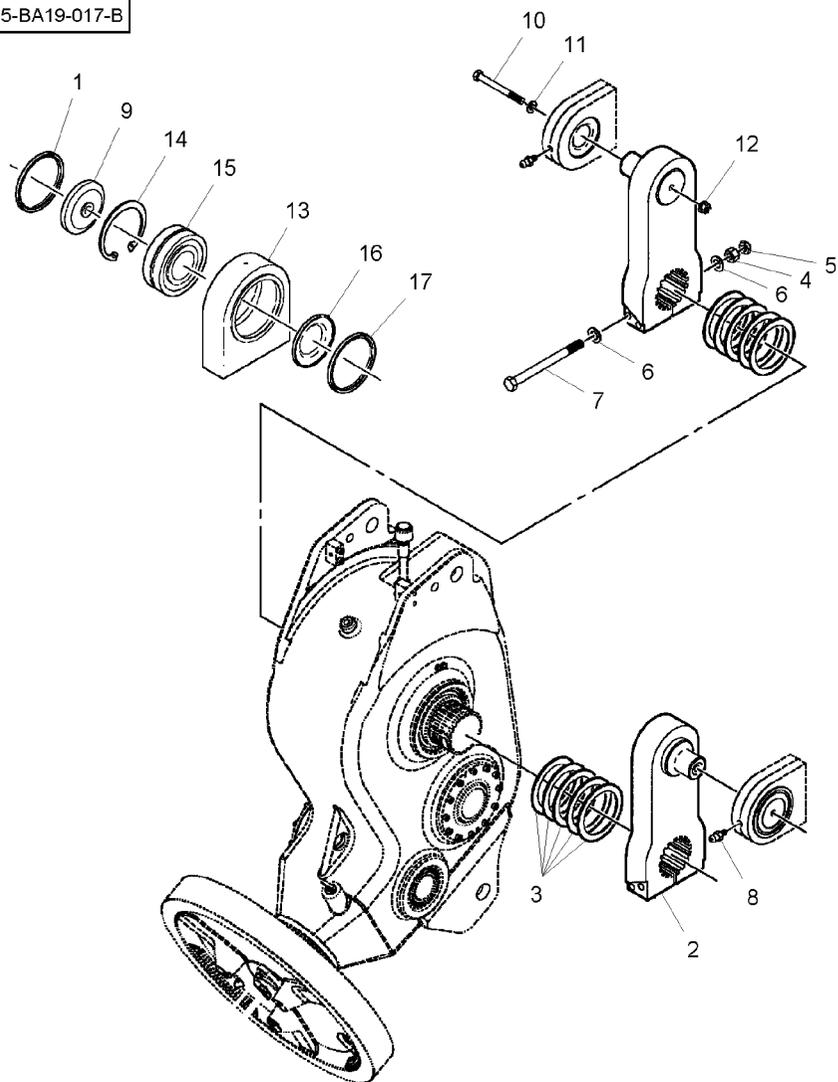

1	700716383		2	OIL SEAL	BAGUE ETANCHEITE	OELDICHRING
2	★700164429		2	CRANK	BOCCOLA PARAOLIO	BUJE RETENACEITE
3	700708038	⚡ 0.25/.010	3	SHIM	MANIVELLE	KURBEL
3	700708039	⚡ 0.64/.025	2	SHIM	MANOVELLA	MANIVELA
3	700708041	⚡ 1.27/.050	3	SHIM	CALE REGLAGE	EINSTELLBLECH
4	★7774292	1"-8	2	SHIM	SPESSORE	CALCE
5	Y704684	1"-8	5	SHIM	CALE REGLAGE	EINSTELLBLECH
6	2700076	1"	4	NUT	SPESSORE	CALCE
7	700707996	1"-8 X 12	4	NUT	ECROU	MUTTER
8	70923219	1/4"-28	4	NUT	DADO	TUERCA
9	★700138991	➡ HP 91100	8	WASHER	DADO	TUERCA
9	★700164437	➡ HP 91101	8	WASHER	RONDELLE	UNTERLEGSCHIEBE
10	★70936419	3/4"-10 X 7-1/2	2	GREASER	RONDELLA	ARANDELA
11	Y705566	3/4"	4	BOLT	BOULON	MASCH.SCHRAUBE
12	700710072	3/4"-10	2	GREASER	BULLONE	ESPIGA/BULON
13	700129487P		2	BUSH	GRAISSEUR	FETTNIFFEL
14	8052144		2	BUSH	INGRASSATORE	ENGRASADOR
15	★700724470		2	BUSH	BAGUE	BUCHSE
16	700129488P		2	BUSH	BOCCOLA	CASQUILLO
17	700716382		1	CAPSCREW	BAGUE	BUCHSE
			2	BUSH	BOCCOLA	CASQUILLO
			1	WASHER	BOCCOLA	CASQUILLO
			1	WASHER	VIS BOUCHON	HUTSCHRAUBE
			1	NUT	TAPPO A VITE	TORNILLO TAPON
			1	NUT	RONDELLE	UNTERLEGSCHIEBE
			1	NUT	RONDELLE	ARANDELA
			2	BEARING HOUSING	ECROU	MUTTER
			2	BEARING HOUSING	DADO	TUERCA
			2	BEARING HOUSING	CARTER ROULEMENT	LAGERGEHAEUSE
			2	BEARING HOUSING	CARCASSA CUSCIN.	CAJA COJINETE
			2	BEARING HOUSING	ANNEAU	RING
			2	BEARING HOUSING	ANELLO	ARO
			2	BEARING HOUSING	ROULEMNT SPHERIC	LAGER-BALLIG
			2	BEARING HOUSING	CUSCINETTO SFER.	COJINETE OSCIL.
			2	BEARING HOUSING	ENTRETOISE	ABSTANDSTUECK
			2	BEARING HOUSING	DISTANZIALE	DISCO ESPACIADOR
			2	BEARING HOUSING	BAGUE ETANCHEITE	OELDICHRING
			2	BEARING HOUSING	BOCCOLA PARAOLIO	BUJE RETENACEITE

Gearbox
Boîte De Vitesses
Getriebe
Cambio Di Velocità
Caja De Cambios

10-65

➔ 190LB-50186

5-BA19-007-B

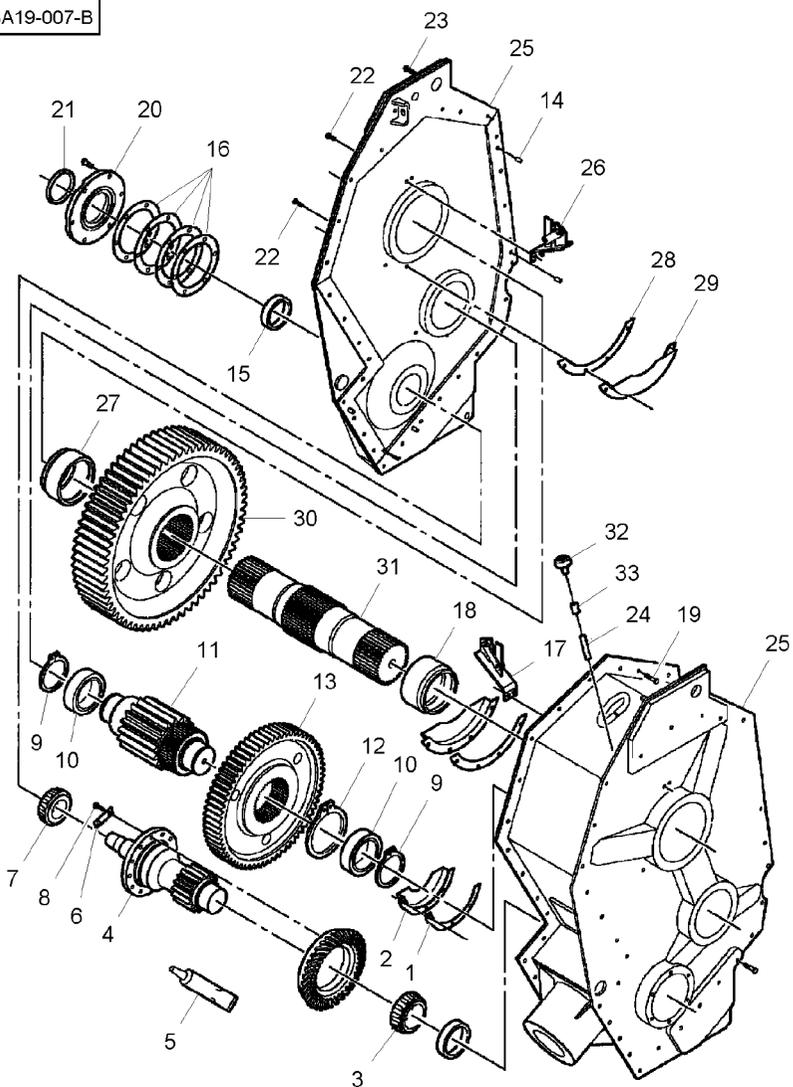

0	700122641		1	GEARBOX	BOITE VITESSES	ZAHNRADGETRIEBE
1	700706080		1	GASKET	SCATOLA CAMBIO	CAJA CAMBIO
2	700113004			JOINT	GUARNIZIONE	DICHTSCHEIBE
3	700706033		1	FLANGE	FLASQUE	EMPAQUETADURA.
4	700706089			FLANGIA	FLANGIA	FLANSCH
5	LC2312031		1	BEARING CONE	CONE ROULEMENT	LAGERINNENRING
6	700112985			CONO CUSCINETTO	PIGNON	CONO COJINETE
7	70932875		1	PINION	PIGNONE	RITZEL
8	700708353	M12 X 40	1	CLEAR.SIL.310ML	CLEAR.SIL.310ML	PINON
9	70927764		6	CLEAR.SIL.310ML	PLAQUE BLOCAGE	CLEAR.SIL.310ML
10	700706040		6	LOCKING PLATE	PIASTRA DI FERMO	CLEAR.SIL.310ML
11	700706091		1	BEARING	COUSSINET	SICH.BLECH
12	7052020			COUSSINET	CUSCINETTO	PLACA DE BLOCAJE
13	700706090		1	BEARING	CUSCINETTO	LAGER
14	700706048		12	CAPSCREW	VIS BOUCHON	LAGER
15	70068847			HUTSCHRAUBE	TAPPO A VITE	COJINETE
16	700706074	0.08/.003	2	SNAPRING	SEGMENT ARRET	HUTSCHRAUBE
16	700706075	0.13/.005		TORNILLO TAPON	ANELLO SIEGER	SPRENGRING
16	700706076	0.25/.010	2	BEARING	COUSSINET	ANILLA RETENCION
16	700706078	0.51/.020		LAGER	CUSCINETTO	LAGER
17	700112991		1	PINION	PIGNON	COJINETE
18	700113017			PINON	PIGNONE	RITZEL
19	11113421	M12 X 60	1	CIRCLIP	CIRCLIP	PINON
19	700708343	M12	1	GEAR	ANNELLO ELASTICO	SEEGERING
19	3009695X1	M12		ENGRANAGE	ENGRENAGE	GRAPA CIRCULAR
20	700113014		1	INGRANAGGIO	INGRANAGGIO	ZAHNRAD
			4	DOWEL	PLOT	ENGRANAJE
				SPINA	SPINA	ZYLINDERSTIFT
			1	BEARING CUP	CUVETTE ROULEMNT	CENTRAJE
				LAGERAUSSENRING	COPPA CUSCINETTO	LAGERAUSSENRING
			2	SHIM	CALE REGLAGE	ANILLO COJINETE
				EINSTELLBLECH	SPESSORE	EINSTELLBLECH
			1	SHIM	CALE REGLAGE	CALCE
				EINSTELLBLECH	SPESSORE	CALCE
			1	SHIM	CALE REGLAGE	EINSTELLBLECH
				EINSTELLBLECH	SPESSORE	CALCE
			2	SHIM	CALE REGLAGE	EINSTELLBLECH
				EINSTELLBLECH	SPESSORE	CALCE
			1	SCRAPER	RACLEUR	ABSTREICHER
				RASPADOR	RUSPA	RASPADOR
			1	SPACER	ENTRETOISE	ABSTANDSTUECK
				DISCO ESPACIADOR	DISTANZIALE	DISCO ESPACIADOR
			8	CAPSCREW	VIS BOUCHON	HUTSCHRAUBE
				TORNILLO TAPON	TAPPO A VITE	TORNILLO TAPON
			8	LOCK WASHER	RONDELLE FREIN	FEDERRING
				ARANDELA GROWER	ROSETTA DENTELL.	ARANDELA GROWER
			8	NUT	ECROU	MUTTER
				TUERCA	DADO	TUERCA
			1	CAP	CHAPEAU	KAPPE
				TAPA	CAPUCHON	TAPA

Gearbox
Boîte De Vitesses
Getriebe
Cambio Di Velocità
Caja De Cambios

10-65

➔ 190LB-50186

5-BA19-007-B

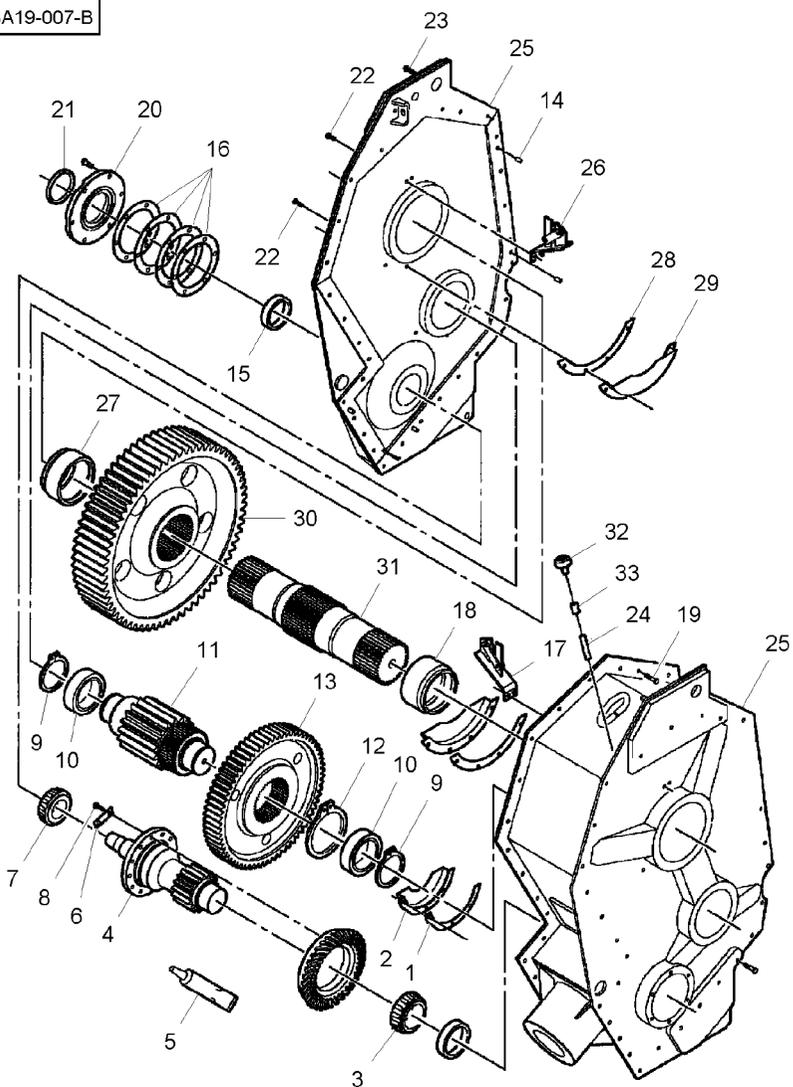

21 700706046

22 700708349

23★700708353

23★700708343

23★3009695X1

24 746313

25 700122642

26 700112992

27 700113018

28 700706079

29 700113003

30 700706092

31 700112989

32 **8799280**

33 Y746354

M10 X 25

M12 X 40

M12

M12

1 SEAL

15 CAPSCREW

19 CAPSCREW

19 LOCK WASHER

19 NUT

1 NIPPLE

1 GEARBOX

1 SCRAPER

1 SPACER

2 GASKET

2 FLANGE

1 GEAR

1 SHAFT

1 FILTER

1 COUPLING

JOINT ETANCHEITE

ANELLO RACCORD

VIS BOUCHON

TAPPO A VITE

VIS BOUCHON

TAPPO A VITE

RONDELLE FREIN

ROSETTA DENTELL.

ECROU

DADO

GRAISSEUR COUDE

NIPPLO

BOITE VITESSES

SCATOLA CAMBIO

RACLEUR

RUSPA

ENTRETOISE

DISTANZIALE

JOINT

GUARNIZIONE

FLASQUE

FLANGIA

ENGRENAGE

INGRANAGGIO

ARBRE

ALBERO

FILTRE

FILTRO

CRABOT

INNESTO

DICHTRING

ARENDELA D'JUNTA

HUTSCHRAUBE

TORNILLO TAPON

HUTSCHRAUBE

TORNILLO TAPON

FEDERRING

ARANDELA GROWER

MUTTER

TUERCA

NIPPEL

NIPPEL

ZAHNRADGETRIEBE

CAJA CAMBIO

ABSTREICHER

RASPADOR

ABSTANDSTUECK

DISCO ESPACIADOR

DICHTSCHEIBE

EMPAQUETADURA.

FLANSCH

PLETINA

ZAHNRAD

ENGRANAJE

WELLE

ARBOL

FILTER

FILTRO

KUPPLUNG

ACOPLAMIENTO

Gearbox
Boîte De Vitesses
Getriebe
Cambio Di Velocità
Caja De Cambios

10-70

➔ 190LB-50186

5-BA19-008-B

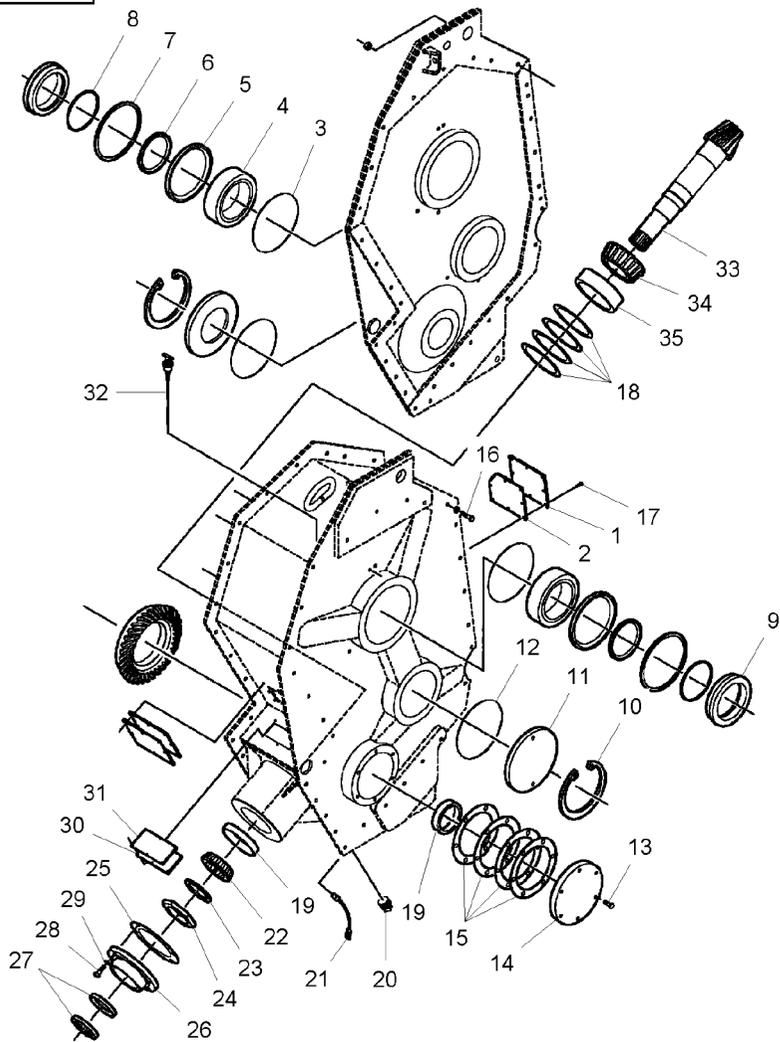

18	700706066	⊗ 0.25/.010	1 SHIM	CALE REGLAGE	EINSTELLBLECH
19	700706034		2 BEARING CUP	SPESSORE	CALCE
20	792051	1"-1/4	1 PLUG	CUVETTE ROULEMNT	LAGERAUSSENRING
21	700706142		1 THERMOSTAT	COPPA CUSCINETTO	ANILLO COJINETE
22	700706030		1 BEARING CONE	BOUCHON	VERSCHL.STOPFEN
23	700706032		1 WASHER	TAPPO	TAPON
24	700706065		1 NUT	THERMOSTAT	THERMOSTAT
25	700713657		1 GASKET	TERMOSTATO	TERMOSTATO
26	700124035		1 CAP	CONE ROULEMENT	LAGERINNENRING
27	700706045		2 SEAL	CONO CUSCINETTO	CONO COJINETE
28	700708350	M10 X 30	6 CAPSCREW	RONDELLE	UNTERLEGSCHIEBE
29	700708367	M10	6 LOCK WASHER	RONDELLA	ARANDELA
30	700706082		1 GASKET	ECROU	MUTTER
31	700113011		1 COVER	DADO	TUERCA
32	700706144		1 OIL DIPSTICK	JOINT	DICHTSCHIEBE
33	700706088		1 PINION	GUARNIZIONE	EMPAQUETADURA.
34	700706027		1 BEARING CONE	CHAPEAU	KAPPE
35	700706029		1 BEARING CUP	CAPUCHON	TAPA
				JOINT ETANCHEITE	DICHTRING
				ANELLO RACCORD	ARENDELA D'JUNTA
				VIS BOUCHON	HUTSCHRAUBE
				TAPPO A VITE	TORNILLO TAPON
				RONDELLE FREIN	FEDERRING
				ROSETTA DENTELL.	ARANDELA GROWER
				JOINT	DICHTSCHIEBE
				GUARNIZIONE	EMPAQUETADURA.
				COUVERCLE	DECKEL
				COPERCHIO	CUBIERTA
				JAUGE D HUILE	OELMESSTAB
				STECCA OLIO	VARILLA NIVEL A
				PIGNON	RITZEL
				PIGNONE	PINON
				CONE ROULEMENT	LAGERINNENRING
				CONO CUSCINETTO	CONO COJINETE
				CUVETTE ROULEMNT	LAGERAUSSENRING
				COPPA CUSCINETTO	ANILLO COJINETE

Gearbox
Boîte De Vitesses
Getriebe
Cambio Di Velocità
Caja De Cambios

10-75

➔ 190LB-50187

5-BA19-011-C

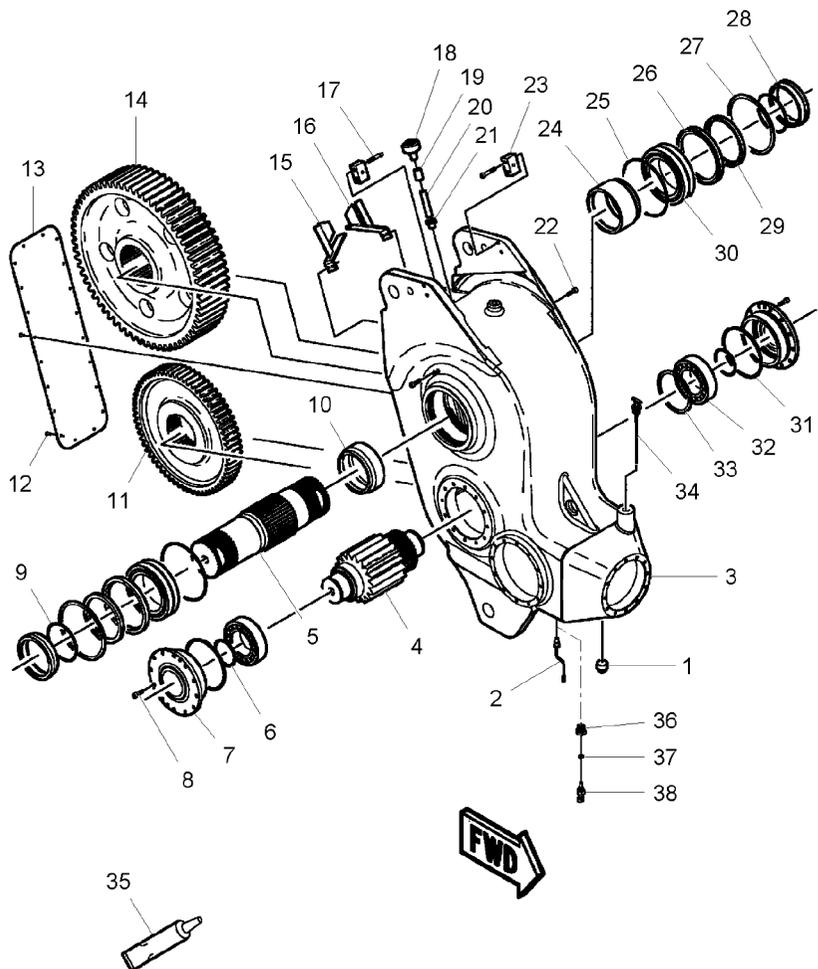

0 700715980	➔ HN 91150	1 GEARBOX	BOITE VITESSES	ZAHNRADGETRIEBE
0★700722210	[A]	1 GEARBOX	SCATOLA CAMBIO	CAJA CAMBIO
1★792051	➔ HN 91151	1 PLUG	BOITE VITESSES	ZAHNRADGETRIEBE
2★700716952	➔ HN 91150	1 THERMOSTAT	SCATOLA CAMBIO	CAJA CAMBIO
3★700715981		1 HOUSING	BOUCHON	VERSCHL.STOPFEN
4★700706091		1 PINION	TAPPO	TAPON
5★700112989		1 SHAFT	TERMOSTAT	THERMOSTAT
6★70927764		2 SNAPRING	TERMOSTATO	TERMOSTATO
7★700715984		2 CARRIER	CARTER	GEHAUSE
8★700717685	M12 X 35	24 SCREW	CARASSA	ALOJAMIENTO
9★70923593		2 O RING	PIGNON	RITZEL
10★700715988		1 SPACER	PIGNONE	PINON
11★700706090		1 GEAR	ARBRE	WELLE
12★700708358	M8 X 16	20 CAPSCREW	ALBERO	ARBOL
13★700715986		1 COVER	SEGMENT ARRET	SPRENGRING
14★700706092		1 GEAR	ANELLO SIEGER	ANILLA RETENCION
15★700112992		1 SCRAPER	PORTE SATELLITES	TRAEGER
16★700112991		1 SCRAPER	SUPPORTO SATELL.	PORTADOR
17★700720027	M12 X 60	4 SCREW	VIS	SCHRAUBE
18★8799280		1 FILTER	VITE	TORNILLO
19★Y746354		1 COUPLING	JOINT TORIQUE	O-RING
20★746313		6 NIPPLE	ANELLO TENUTA	ANILLO FORMA 'O'
21★70901828		1 BUSH	ENTRETOISE	ABSTANDSTUECK
22★700717684	M10 X 30	4 SCREW	DISTANZIALE	DISCO ESPACIADOR
23★700716685		2 BAR	ENGRENAGE	ZAHNRAD
24★700715989		1 SPACER	INGRANAGGIO	ENGRANAJE
			VIS BOUCHON	HUTSCHRAUBE
			TAPPO A VITE	TORNILLO TAPON
			COUVERCLE	DECKEL
			COPERCHIO	CUBIERTA
			ENGRENAGE	ZAHNRAD
			INGRANAGGIO	ENGRANAJE
			RACLEUR	ABSTREICHER
			RUSPA	RASPADOR
			RACLEUR	ABSTREICHER
			RUSPA	RASPADOR
			VIS	SCHRAUBE
			VITE	TORNILLO
			FILTRE	FILTER
			FILTRO	FILTRO
			CRABOT	KUPPLUNG
			INNESTO	ACOPLAMIENTO
			GRAISSEUR COUDE	NIPPEL
			NIPPLO	NIPLE
			BAGUE	BUCHSE
			BOCCOLA	CASQUILLO
			VIS	SCHRAUBE
			VITE	TORNILLO
			BARRE	STAB
			BARRA	BARRA
			ENTRETOISE	ABSTANDSTUECK
			DISTANZIALE	DISCO ESPACIADOR

Gearbox
Boîte De Vitesses
Getriebe
Cambio Di Velocità
Caja De Cambios

10-75

➔ 190LB-50187

5-BA19-011-C

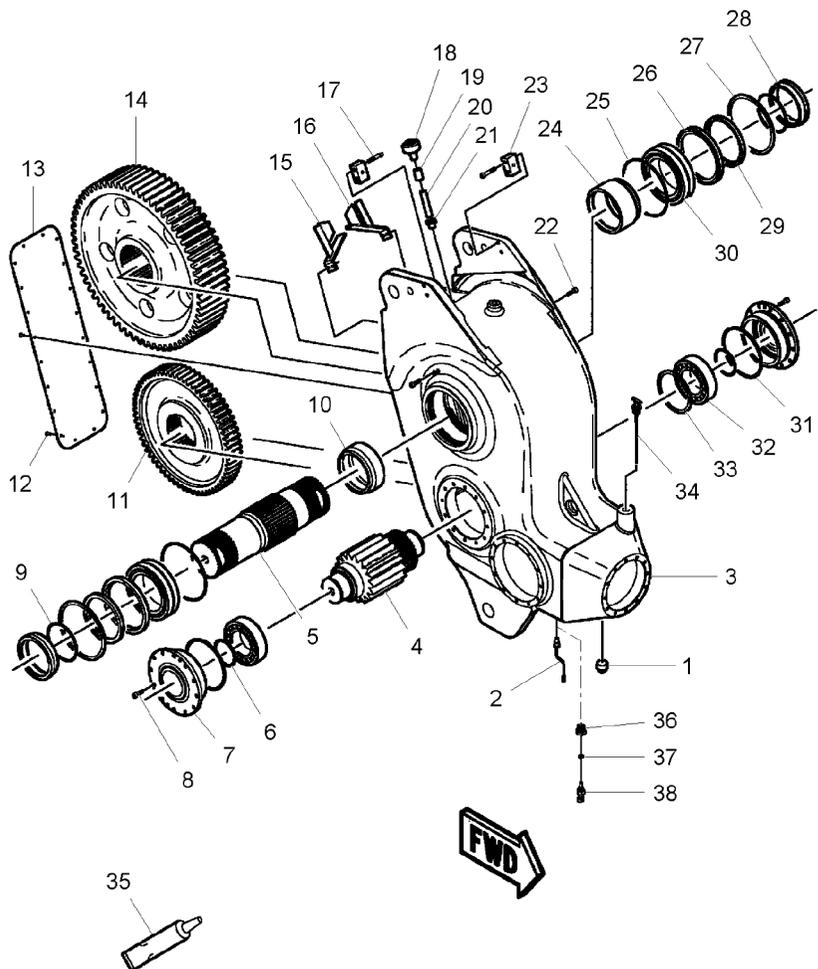

25★700706049

26★700112993P

27★700708037

28★700112988

29★700708000

30★700706041

31★700720023

32★700706040

33★7052020

34★700706144

35★LC2312031

36★700153111

37★7040330

38★71393718

[A]
➔ HN 91151
[A]
➔ HN 91151
[A]
➔ HN 91151

[A] WITH ELECTRONIC CONTROL
AVEC CONTROLE ELECTRONIQUE
MIT ELEKTRONISCHE STEUERUNG
CON CONTROLLO ELETTRONICO
CON CONTROL ELECTRONICO

2 O RING

2 CAP

2 CIRCLIP

2 SPACER

2 SEAL

2 BEARING

2 O RING

2 BEARING

1 CIRCLIP

1 OIL DIPSTICK

1 CLEAR.SIL.310ML

1 ADAPTOR

1 O RING

1 SENSOR

JOINT TORIQUE
ANELLO TENUTA

CHAPEAU
CAPUCHON

CIRCLIP
ANELLO ELASTICO

ENTRETOISE
DISTANZIALE

JOINT ETANCHEITE
ANELLO RACCORD

COUSSINET
CUSCINETTO

JOINT TORIQUE
ANELLO TENUTA

COUSSINET
CUSCINETTO

CIRCLIP
ANELLO ELASTICO

JAUGE D HUILE
STECCA OLIO

CLEAR.SIL.310ML
CLEAR.SIL.310ML

ADAPTATEUR
ADATTATORE

JOINT TORIQUE
ANELLO TENUTA

DETECTEUR
SENSORE

O-RING

ANILLO FORMA 'O'

KAPPE

TAPA

SEEGERING

GRAPA CIRCULAR

ABSTANDSTUECK

DISCO ESPACIADOR

DICHRING

ARENDELA D'JUNTA

LAGER

COJINETE

O-RING

ANILLO FORMA 'O'

LAGER

COJINETE

SEEGERING

GRAPA CIRCULAR

OELMESSTAB

VARILLA NIVEL A

CLEAR.SIL.310ML

CLEAR.SIL.310ML

REDUZIERNIPPEL

ADAPTADOR

O-RING

ANILLO FORMA 'O'

EMPFANGER

DETECTOR

Gearbox
Boîte De Vitesses
Getriebe
Cambio Di Velocità
Caja De Cambios

10-80

➔ 190LB-50187

5-BA19-012-B

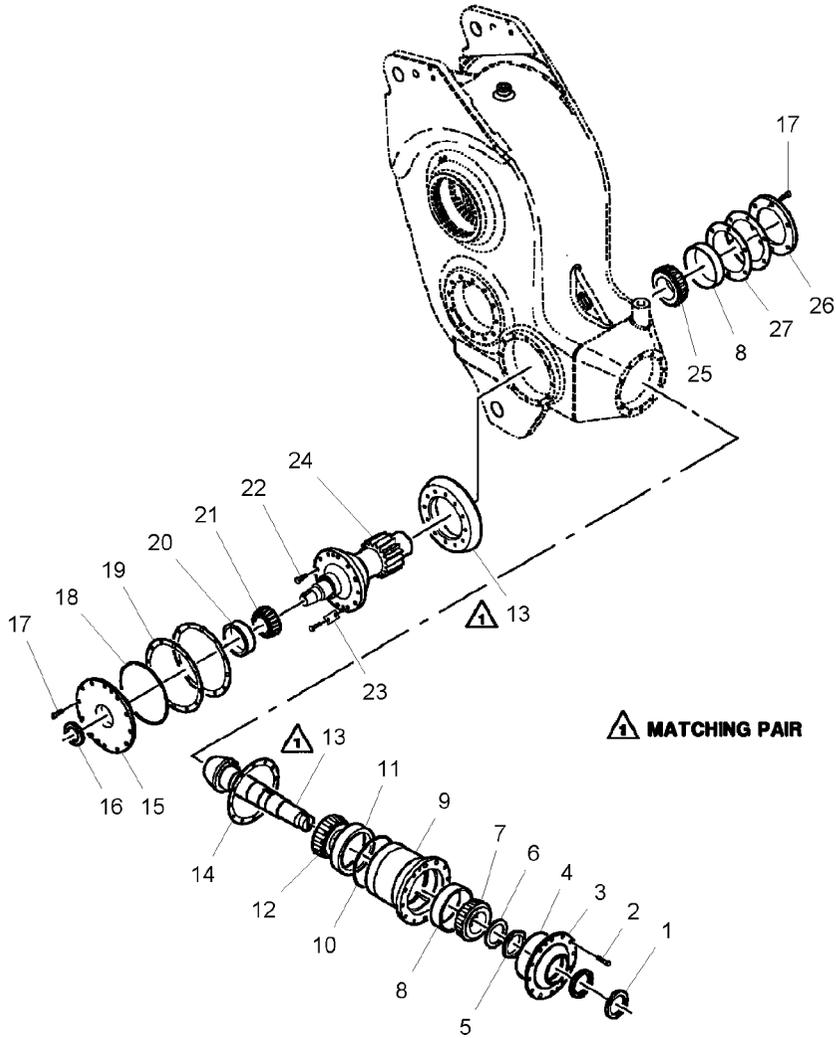

0	700715980	➔ HN 91150	1	GEARBOX	BOITE VITESSES	ZAHNRADGETRIEBE
0	★700722210	[A]	1	GEARBOX	SCATOLA CAMBIO	CAJA CAMBIO
1	★700706045	➔ HN 91151	1	GEARBOX	BOITE VITESSES	ZAHNRADGETRIEBE
2	★7771926		2	SEAL	SCATOLA CAMBIO	CAJA CAMBIO
3	★700715985		12	CAPSCREW	JOINT ETANCHEITE	DICHRING
4	★70923596	M12 X 45			ANELLO RACCORD	ARENDELA D'JUNTA
5	★700706065		1	HOUSING	VIS BOUCHON	HUTSCHRAUBE
6	★700706032		1	O RING	TAPPO A VITE	TORNILLO TAPON
7	★700706030		1	HOUSING	CARTER	GEHAEUSE
8	★700706034		1	O RING	CARCASSA	ALOJAMIENTO
9	★700715983		1	NUT	JOINT TORIQUE	O-RING
10	★700720023		1	WASHER	ANELLO TENUTA	ANILLO FORMA 'O'
11	★700706029		1	BEARING CONE	ECROU	MUTTER
12	★700706027		1	BEARING CUP	DADO	TUERCA
13	★700706088		2	BEARING CUP	RONDELLE	UNTERLEGSCHIEBE
14	★700715991		1	HOUSING	RONDELLA	ARANDELA
15	★700715982		1	O RING	CONE ROULEMENT	LAGERINNENRING
16	★700717687		2	BEARING CUP	CONO CUSCINETTO	CONO COJINETE
17	★700717685	M12 X 35	1	HOUSING	CUVETTE ROULEMNT	LAGERAUSSENRING
18	★700717688		1	BEARING CONE	COPPA CUSCINETTO	ANILLO COJINETE
19	★700715992		1	PINION	CARTER	GEHAEUSE
20	★70068847		1	KIT, SHIMS	CARCASSA	ALOJAMIENTO
21	★70932875		1	CARRIER	JOINT TORIQUE	O-RING
22	★700708353	M12 X 40	1	BEARING CUP	ANELLO TENUTA	ANILLO FORMA 'O'
23	★700112985		1	BEARING CONE	CUVETTE ROULEMNT	LAGERAUSSENRING
24	★700706089		1	PINION	COPPA CUSCINETTO	ANILLO COJINETE
			1	LOCKING PLATE	CONE ROULEMENT	LAGERINNENRING
			1	PINION	CONO CUSCINETTO	CONO COJINETE
			12	CAPSCREW	PIGNON	RITZEL
			1	PINION	PIGNONE	PINON
			1	KIT, SHIMS	JEU CALES	SATZ BEILAGEN
			1	CARRIER	KIT SPESSORI	JUEGO SUPLEMENTO
			1	OIL SEAL	PORTE SATELLITES	TRAEGER
			1	SCREW	SUPPORTO SATELL.	PORTADOR
			1	O RING	BAGUE ETANCHEITE	OELDICHTRING
			1	KIT, SHIMS	BOCCOLA PARAOLIO	BUJE RETENACEITE
			1	BEARING CUP	VIS	SCHRAUBE
			1	BEARING	VITE	TORNILLO
			1	O RING	JOINT TORIQUE	O-RING
			1	KIT, SHIMS	ANELLO TENUTA	ANILLO FORMA 'O'
			1	BEARING CUP	JEU CALES	SATZ BEILAGEN
			1	BEARING	KIT SPESSORI	JUEGO SUPLEMENTO
			12	CAPSCREW	CUVETTE ROULEMNT	LAGERAUSSENRING
			1	LOCKING PLATE	COPPA CUSCINETTO	ANILLO COJINETE
			1	PINION	COUSSINET	LAGER
			1	PINION	CUSCINETTO	COJINETE
			12	CAPSCREW	VIS BOUCHON	HUTSCHRAUBE
			1	LOCKING PLATE	TAPPO A VITE	TORNILLO TAPON
			1	PINION	PLAQUE BLOCAGE	SICH.BLECH
			1	PINION	PIASTRA DI FERMO	PLACA DE BLOCAJE
			1	PINION	PIGNON	RITZEL
			1	PINION	PIGNONE	PINON

Gearbox
Boîte De Vitesses
Getriebe
Cambio Di Velocità
Caja De Cambios

10-80

➔ 190LB-50187

5-BA19-012-B

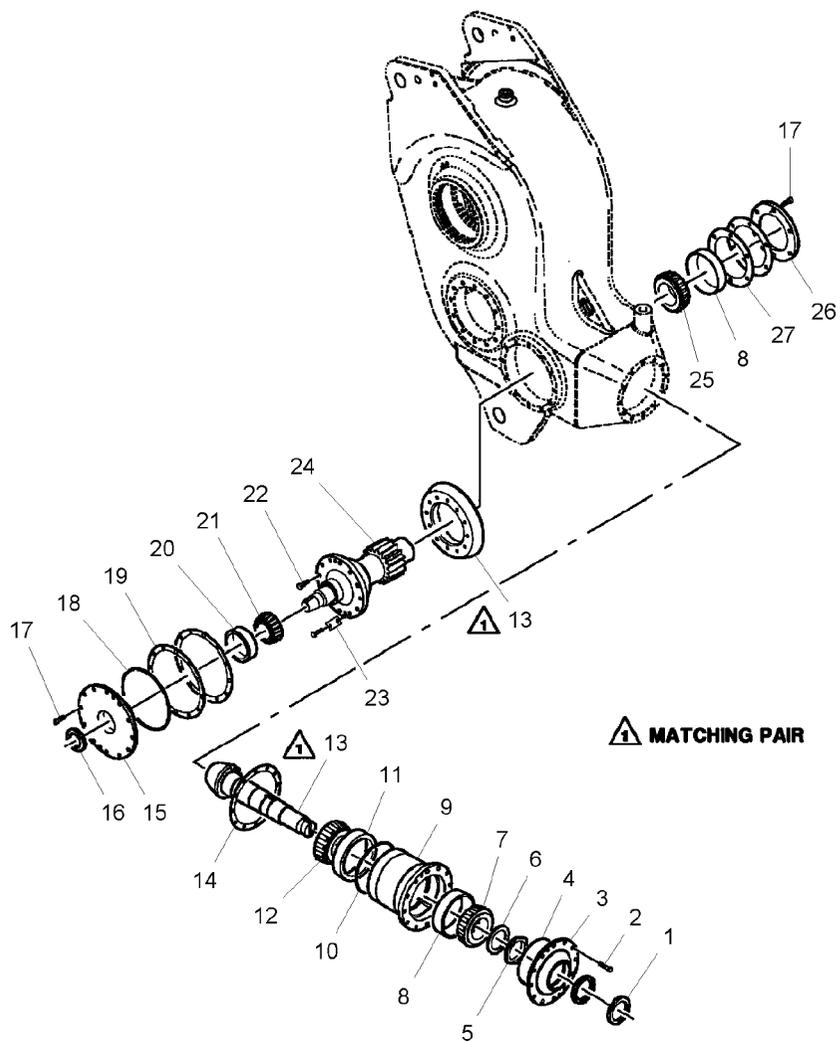

25★700706033

26★700113013P

27★700706070 ✂ 0.08/.003

27★700706071 ✂ 0.13/.005

27★700706072 ✂ 0.25/.010

27★700706073 ✂ 0.51/.020

1 BEARING CONE

1 CAP

3 SHIM

2 SHIM

2 SHIM

2 SHIM

CONE ROULEMENT
CONO CUSCINETTO
CHAPEAU
CAPUCHON
CALE REGLAGE
SPESSORE
CALE REGLAGE
SPESSORE
CALE REGLAGE
SPESSORE
CALE REGLAGE
SPESSORE

LAGERINNENRING
CONO COJINETE
KAPPE
TAPA
EINSTELLBLECH
CALCE
EINSTELLBLECH
CALCE
EINSTELLBLECH
CALCE
EINSTELLBLECH
CALCE

[A] WITH ELECTRONIC CONTROL
AVEC CONTROLE ELECTRONIQUE
MIT ELEKTRONISCHE STEUERUNG
CON CONTROLLO ELETTRONICO
CON CONTROL ELECTRONICO

Chain Drive
Transmission Par Chaîne
Kettenantrieb
Trasmissione A Catena
Accionamiento Cadena

10-85

Left Side - Up To 190lb-50146
Cote Gauche - Jusqu'au 190lb-50146
Linke Seite - Bis 190lb-50146
Lato Sinistro - Fino Alla 190lb-50146
Lado Izquierd - Hasta 190lb-50146

5-BA25-008-C

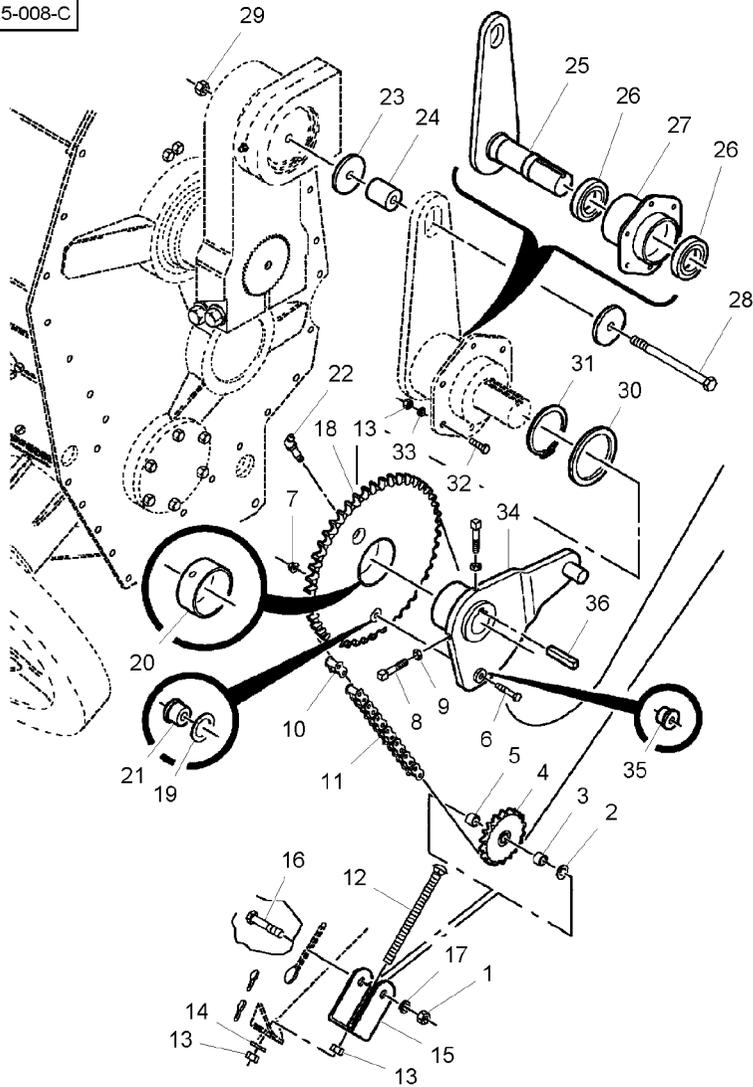

1	70913160	3/4"-10	1 NUT	ECROU	MUTTER
2	Y705566	3/4"	1 WASHER	DADO	TUERCA
3	6823512P		1 SPACER	RONDELLE	UNTERLEGSCHIEBE
4	700706110	12	1 SPROCKET	RONDELLA	ARANDELA
5	6179246		1 BUSH	ENTRETOISE	ABSTANDSTUECK
6	70924666	1/2"-13 X 2-3/4 80-30 No 1	1 CAPSCREW	DISTANZIALE	DISCO ESPACIADOR
7	Y704742	1/2"-13	1 LOCKNUT	BARBOTIN	KETTENRAD
8	355217X1	1/2" X 2-1/2	2 SCREW	RUOTA MOTRICE	RUEDA DE CADENA
9	704056	1/2"-13	2 NUT	BAGUE	BUCHSE
10	86405	ASA 100H	1 LINK	BOCCOLA	CASQUILLO
10	3904530M91	ASA 100H TYPE DIAMOND	1 LINK	VIS BOUCHON	HUTSCHRAUBE
11	W980268US	ASA 100H 10 FOOT	1 ROLL OF CHAIN	TAPPO A VITE	TORNILLO TAPON
11	3904523M91	248 LINKS ASA 100H TYPE DIAMOND	1 CHAIN	ECROU BLOCAGE	SICHERUNGSMUTTER
12	7770878	1/2"-13 X 7	1 BOLT	AUTOBLOCCANTE	CONTRATUERCA
13	704031	1/2"-13	8 NUT	VIS	SCHRAUBE
14	705541	1/2"	1 WASHER	VITE	TORNILLO
15	6526164P		1 CLEVIS	ECROU	MUTTER
16	70925387	3/4"-10 X 4	1 CAPSCREW	DADO	TUERCA
17	70919332	3/4"	1 LOCK WASHER	MAILLON	GLIED
18	700112915	40	1 SPROCKET	MAGLIA	ENLACE
19	Y52266	18 1"-1/4 X 14	1 BUSH	MAILLON	GLIED
20	700112933	18	1 BUSH	MAGLIA	ENLACE
21	6526081	18	1 SLEEVE	ROULEAU CHAINE	KETTE METERWARE
22	77388	1/8"-27 X 90°	1 FITTING	RULLO PER CATENA	CADENA 5M
23	6579106P		2 CAP	CHAINE	KETTE
				CATENA	CADENA
				BOULON	MASCH.SCHRAUBE
				BULLONE	ESPIGA/BULON
				ECROU	MUTTER
				DADO	TUERCA
				RONDELLE	UNTERLEGSCHIEBE
				RONDELLA	ARANDELA
				CHAPE	GABELSTUECK
				GANCIO D'ATTACCO	GANCHO SEGURI.
				VIS BOUCHON	HUTSCHRAUBE
				TAPPO A VITE	TORNILLO TAPON
				RONDELLE FREIN	FEDERRING
				ROSETTA DENTELL.	ARANDELA GROWER
				BARBOTIN	KETTENRAD
				RUOTA MOTRICE	RUEDA DE CADENA
				BAGUE	BUCHSE
				BOCCOLA	CASQUILLO
				BAGUE	BUCHSE
				BOCCOLA	CASQUILLO
				MANCHON	HUELSE
				MANICOTTO	MANCHA
				MONTAGE	ANSCHL.VERSCHRBG
				RACCORDO.	ACCESORIO.
				CHAPEAU	KAPPE
				CAPUCHON	TAPA

Chain Drive
 Transmission Par Chaîne
 Kettenantrieb
 Trasmissione A Catena
 Accionamiento Cadena

10-85

Left Side - Up To 190lb-50146
 Cote Gauche - Jusqu'au 190lb-50146
 Linke Seite - Bis 190lb-50146
 Lato Sinistro - Fino Alla 190lb-50146
 Lado Izquierd - Hasta 190lb-50146

5-BA25-008-C

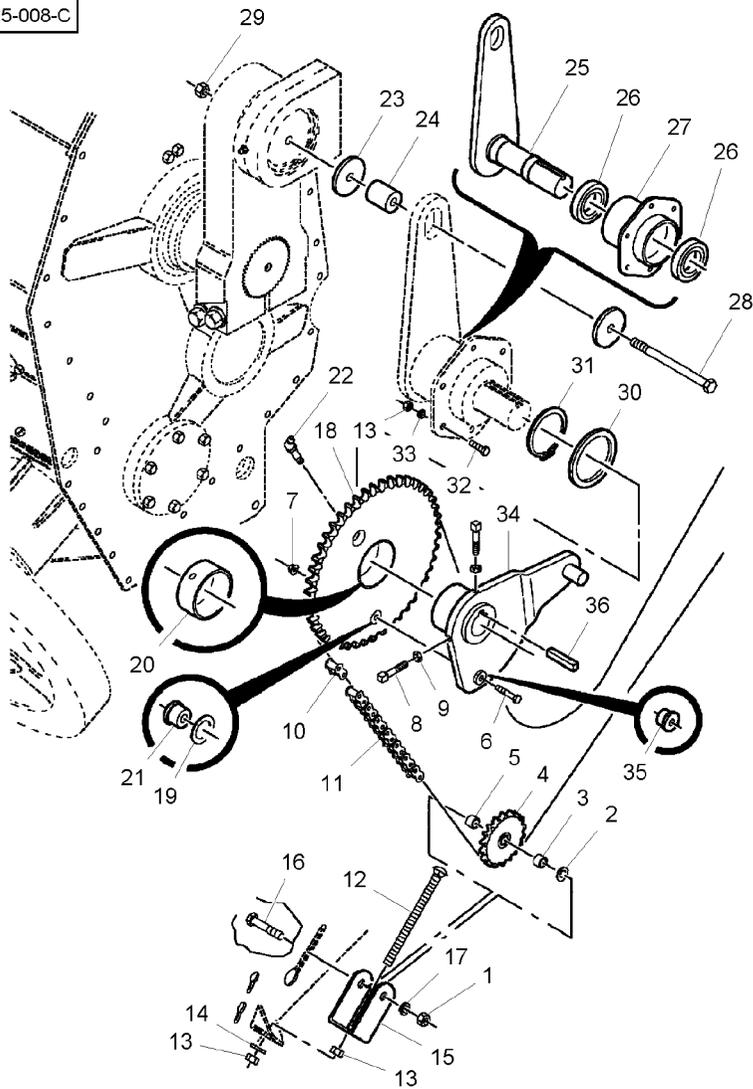

24	700112930P		1 BUSH	BAGUE	BUCHSE
25	700112906		1 ARM	BOCCOLA	CASQUILLO
26	7713894		2 BEARING	BRAS	ARM
27	6526016		1 BRACKET	BRACCIO	BRAZO
28	7773591	3/4"-10 X 10	1 BOLT	COUSSINET	LAGER
29	700710072	3/4"-10	1 NUT	CUSCINETTO	COJINETE
30	700112931		1 WASHER	SUPPORT FIXATION	HALTEARM
31	700706111		1 CIRCLIP	STAFFETTA	SOPORTE
32	70919089	1/2"-13 X 1-3/4	6 CAPSCREW	BOULON	MASCH.SCHRAUBE
33	Y705046	1/2"	6 LOCK WASHER	BULLONE	ESPIGA/BULON
34	700112909		1 HUB	ECROU	MUTTER
35	6526081	34	1 SLEEVE	DADO	TUERCA
36	700112932		1 KEY	RONDELLE	UNTERLEGSCHIEBE
				RONDELLE	ARANDELA
				CIRCLIP	SEEGERING
				ANELLO ELASTICO	GRAPA CIRCULAR
				VIS BOUCHON	HUTSCHRAUBE
				TAPPO A VITE	TORNILLO TAPON
				RONDELLE FREIN	FEDERRING
				ROSETTA DENTELL.	ARANDELA GROWER
				MOYEU	NABE
				MOZZO	CUBO
				MANCHON	HUELSE
				MANICOTTO	MANCHA
				CLAVETTE	PASSKEIL
				CHIAVETTA	CLAVE

Chain Drive
 Transmission Par Chaîne
 Kettenantrieb
 Trasmissione A Catena
 Accionamiento Cadena

10-90

Left Side - From 190lb-50147
 Cote Gauche - A Partir Du 190lb-50147
 Linke Seite - Ab 190lb-50147
 Lato Sinistro - Dalla 190lb-50147
 Lado Izquierdo - A Partir Del 190lb-50147

5-BA25-019-D

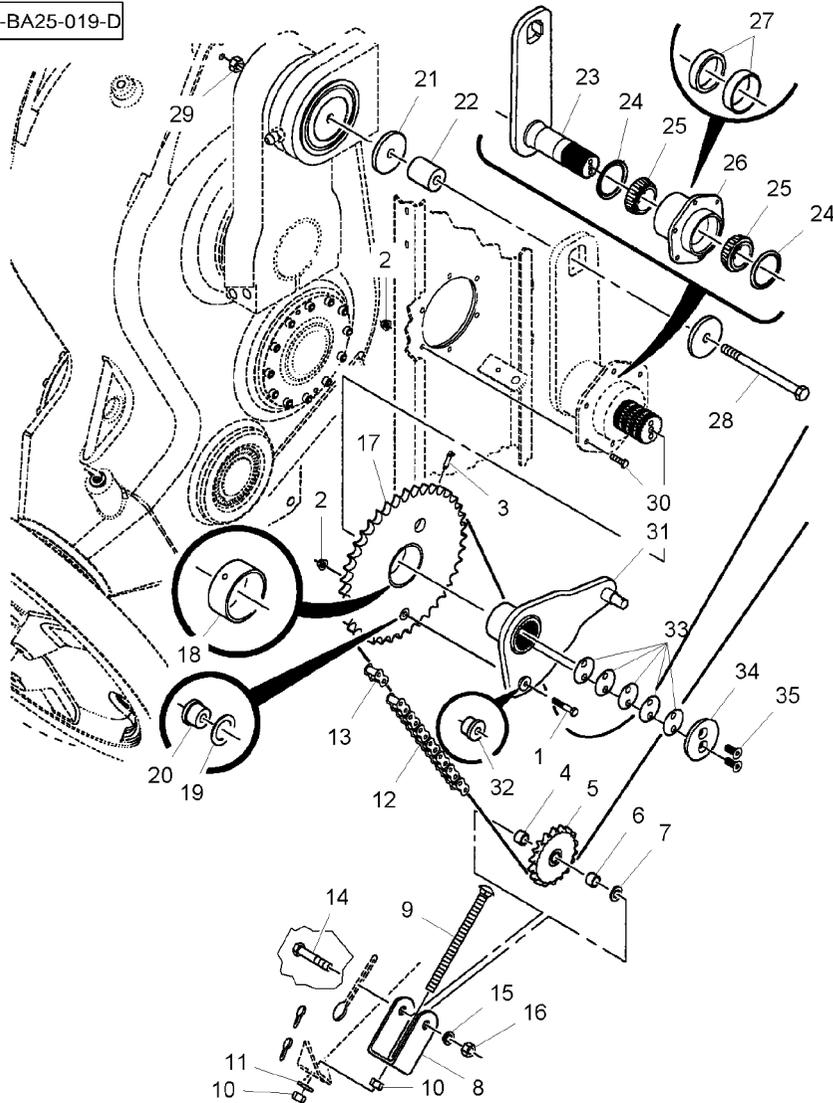

1	★70924666	1/2"-13 X 2-3/4	1	CAPSCREW	VIS BOUCHON	HUTSCHRAUBE
2	Y704742	1/2"-13	7	LOCKNUT	TAPPO A VITE	TORNILLO TAPON
3	77388	1/8"-27 X 90°	1	FITTING	ECROU BLOCAGE	SICHERUNGSMUTTER
4	6179246		1	BUSH	AUTOBLOCCANTE	CONTRATUERCA
5	700706110		1	SPROCKET	MONTAGE RACCORDO.	ANSCHL.VERSCHRBG
6	6823512P		1	SPACER	BAGUE	ACCESORIO.
7	Y705566	3/4"	1	WASHER	BOCCOLA	BUCHSE
8	6526164P		1	CLEVIS	BOCCOLA BARBOTIN	CASQUILLO
9	7770878	1/2"-13 X 7	1	BOLT	RUOTA MOTRICE	KETTENRAD
10	★704031	1/2"-13	1	NUT	ENTRETOISE	RUEDA DE CADENA
11	705541	1/2"	1	WASHER	DISTANZIALE	ABSTANDSTUECK
12	W980268US	ASA 100H	1	ROLL OF CHAIN	RONDELLE	DISCO ESPACIADOR
12	3904523M91	10 FOOT BULK	1	CHAIN	RONDELLE	UNTERLEGSCHIEBE
		248 LINKS			RONDELLA	ARANDELA
		ASA 100H			CHAPE	GABELSTUECK
		TYPE DIAMOND			GANCIO D'ATTACCO	GANCHO SEGUR.
13	86405	ASA 100H	1	LINK	BOULON	MASCH.SCHRAUBE
13	3904530M91	ASA 100H	1	LINK	BULLONE	ESPIGA/BULON
		TYPE DIAMOND			ECROU	MUTTER
14	★70925387	3/4"-10 X 4	1	CAPSCREW	DADO	TUERCA
15	★70919332	3/4"	1	LOCK WASHER	RONDELLE	UNTERLEGSCHIEBE
16	★70913160	3/4"-10	1	NUT	RONDELLA	ARANDELA
17	700112915		1	SPROCKET	ROULEAU CHAINE	KETTE METERWARE
18	700112933	17	1	BUSH	RULLO PER CATENA	CADENA 5M
19	Y52266	17 1"-1/4 X 14	1	BUSH	CHAINE	KETTE
20	★6526081	17	1	SLEEVE	CATENA	CADENA
21	6579106P		2	CAP	MAILLON	GLIED
22	700112930P		1	BUSH	MAGLIA	ENLACE
23	700134942P		1	ARM	MAILLON	GLIED
					MAGLIA	ENLACE
					VIS BOUCHON	HUTSCHRAUBE
					TAPPO A VITE	TORNILLO TAPON
					RONDELLE FREIN	FEDERRING
					ROSETTA DENTELL.	ARANDELA GROWER
					ECROU	MUTTER
					DADO	TUERCA
					BARBOTIN	KETTENRAD
					RUOTA MOTRICE	RUEDA DE CADENA
					BAGUE	BUCHSE
					BOCCOLA	CASQUILLO
					BAGUE	BUCHSE
					BOCCOLA	CASQUILLO
					MANCHON	HUELSE
					MANICOTTO	MANCHA
					CHAPEAU	KAPPE
					CAPUCHON	TAPA
					BAGUE	BUCHSE
					BOCCOLA	CASQUILLO
					BRAS	ARM
					BRACCIO	BRAZO

Chain Drive
Transmission Par Chaîne
Kettenantrieb
Trasmissione A Catena
Accionamiento Cadena

10-90

Left Side - From 190lb-50147
Cote Gauche - A Partir Du 190lb-50147
Linke Seite - Ab 190lb-50147
Lato Sinistro - Dalla 190lb-50147
Lado Izquierdo - A Partir Del 190lb-50147

5-BA25-019-D

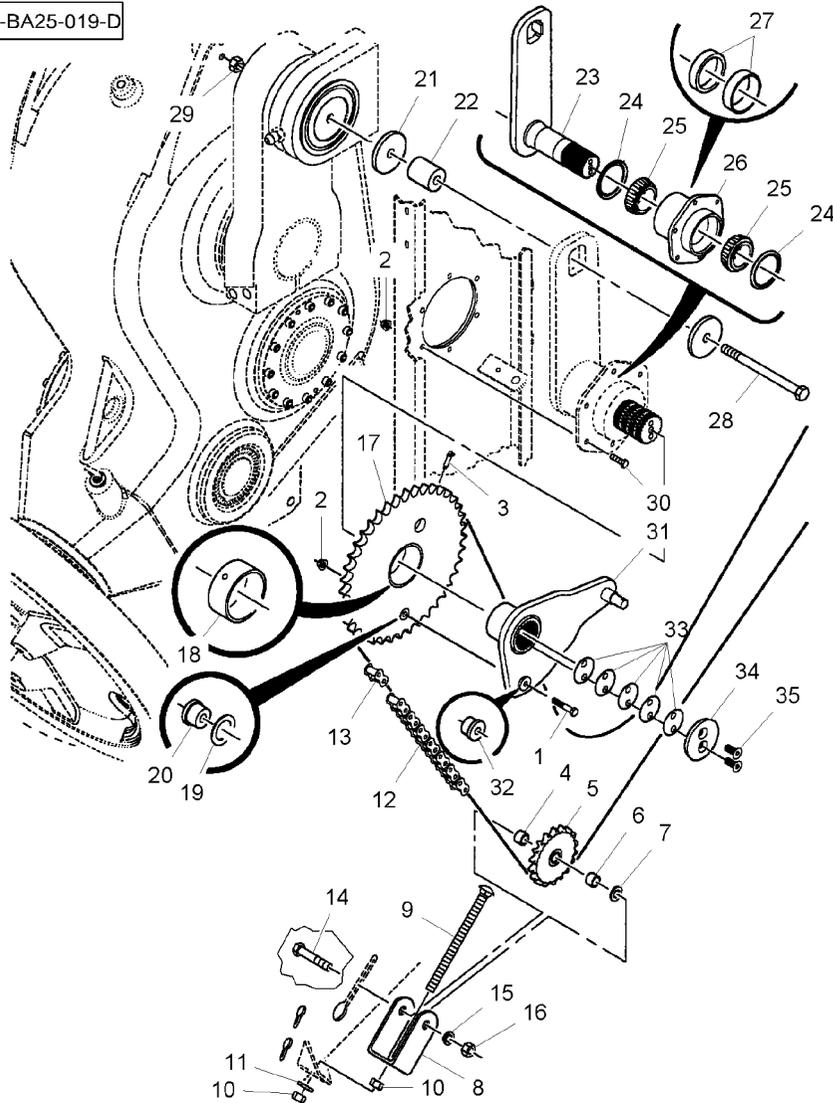

24	700716267		2	SEAL	JOINT ETANCHEITE	DICHTRING
25	70927347		2	BEARING CONE	ANELLO RACCORD	ARENDELA D'JUNTA
26	700134948P		1	HUB	CONE ROULEMENT	LAGERINNENRING
27	70927348	26	2	BEARING CUP	CONO CUSCINETTO	CONO COJINETE
28	7773591	3/4"-10 X 10	1	BOLT	MOYEU	NABE
29	700710072	3/4"-10	1	NUT	MOZZO	CUBO
30	70919089	1/2"-13 X 1-3/4	6	CAPSCREW	CUVETTE ROULEMNT	LAGERAUSSENRING
31	700134945P		1	HUB	COPPA CUSCINETTO	ANILLO COJINETE
32	6526081	31	1	SLEEVE	BOULON	MASCH.SCHRAUBE
33	700716247	0.51/.020	1	SHIM	BULLONE	ESPIGA/BULON
33	700716244	0.08/.003	2	SHIM	ECROU	MUTTER
33	700716245	0.13/.005	1	SHIM	DADO	TUERCA
33	700716246	0.25/.010	1	SHIM	VIS BOUCHON	HUTSCHRAUBE
34	700134951P		1	RETAINER	TAPPO A VITE	TORNILLO TAPON
35	700706852	5/8-11 X 1-1/2	2	CAPSCREW	MOYEU	NABE
					MOZZO	CUBO
					MANCHON	HUELSE
					MANICOTTO	MANCHA
					CALE REGLAGE	EINSTELLBLECH
					SPESSORE	CALCE
					CALE REGLAGE	EINSTELLBLECH
					SPESSORE	CALCE
					CALE REGLAGE	EINSTELLBLECH
					SPESSORE	CALCE
					CALE REGLAGE	EINSTELLBLECH
					SPESSORE	CALCE
					RETENEUR	HALTERING
					FERMO	RETENEDOR
					VIS BOUCHON	HUTSCHRAUBE
					TAPPO A VITE	TORNILLO TAPON

Chain Drive
 Transmission Par Chaîne
 Kettenantrieb
 Trasmisione A Catena
 Accionamiento Cadena

10-95

Right Side - Up To H.K 91220
 Cote Droit - Jusqu'au H.K 91220
 Rechte Seite - Bis H.K 91220
 Lado Destra - Fino Alla H.K 91220
 Lado Derecho - Hasta H.K 91220

5-BA25-009-C

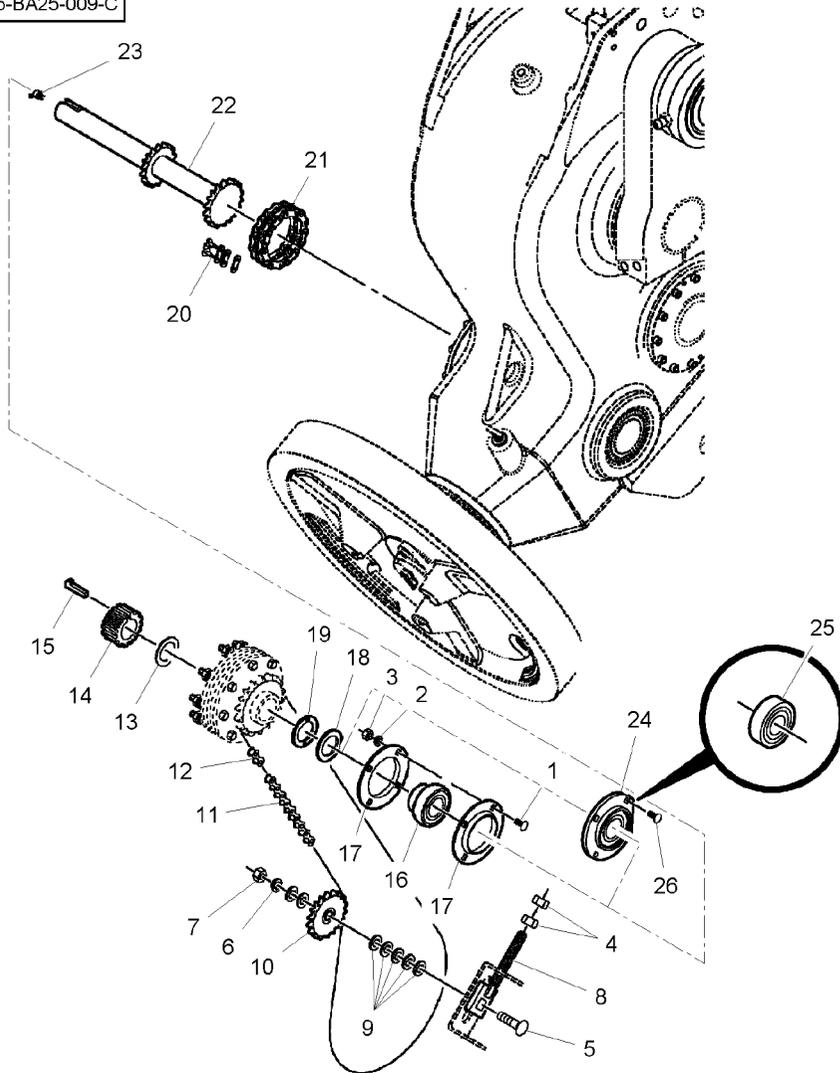

1	68619	➡ 190LB-50214	4 BOLT	BOULON	MASCH.SCHRAUBE
2	Y705046	1/2"-13 X 1-1/4	4 LOCK WASHER	BULLONE	ESPIGA/BULON
3	704031	1/2"-13	4 NUT	RONDELLE FREIN	FEDERRING
4	70932665	5/8"-11	2 NUT	ROSETTA DENTELL.	ARANDELA GROWER
5	364423X1	3/4-10 X 3	1 BOLT	ECROU	MUTTER
6	70919332	3/4"	1 LOCK WASHER	DADO	TUERCA
7	70913160	3/4"-10	1 NUT	ECROU	MUTTER
8	700112926P		1 BOLT	DADO	TUERCA
9	Y705566	3/4"	7 WASHER	BOULON	MASCH.SCHRAUBE
10	Y747931		1 SPROCKET	BULLONE	ESPIGA/BULON
11	7087935	ASA 80H	1 CHAIN	RONDELLE FREIN	FEDERRING
11	3904527M91	10 FOOT BULK	1 CHAIN	ROSETTA DENTELL.	ARANDELA GROWER
12	7088008	ASA80H - CONNECT	1 LINK	ECROU	MUTTER
12	3904529M91	ASA80H - CONNECT	1 LINK	DADO	TUERCA
13	740407	2" X 10	1 BUSH	BOULON	MASCH.SCHRAUBE
14	700112925		1 HUB	BULLONE	ESPIGA/BULON
15	700706643		1 KEY	RONDELLE	UNTERLEGSCHIEBE
16	712158	➡ 190LB-50214	1 BEARING	RONDELLA	ARANDELA
17	714360	➡ 190LB-50214	2 FLANGE	BARBOTIN	KETTENRAD
18	852806	2" X .188	1 BUSH	RUOTA MOTRICE	RUEDA DE CADENA
19	8052177	2" X .125	1 BUSH	CHAINE	KETTE
20	329278M91	ASA60-CONNECTOR	1 LINK	CATENA	CADENA
20	329421M91	ASA60-OFFSET	1 CRANKED LINK	CHAINE	KETTE
21	*	ASA60-18LINKS	1 CHAIN	CATENA	CADENA
22	700112919	➡ 3030181M91 ◀ 5M	1 SHAFT		

Chain Drive
 Transmission Par Chaîne
 Kettenantrieb
 Trasmisione A Catena
 Accionamiento Cadena

10-95

Right Side - Up To H.K 91220
 Cote Droit - Jusqu'au H.K 91220
 Rechte Seite - Bis H.K 91220
 Lado Destra - Fino Alla H.K 91220
 Lado Derecho - Hasta H.K 91220

5-BA25-009-C

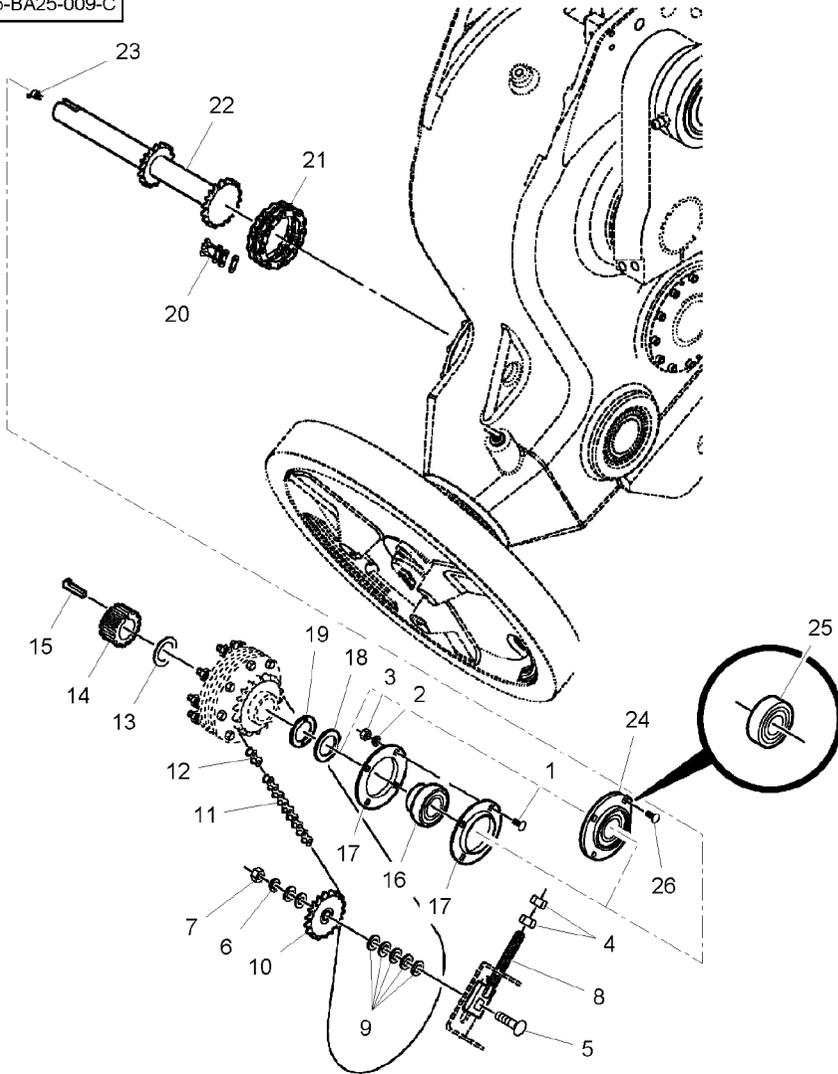

23 ★ 70915275

1/8"-27 X 65°

1 GREASER

GRAISSEUR

FETTNIPPEL

24 700109753P

➡ 190LB-50215

1 BEARING FLANGE

INGRASSATORE

ENGRASADOR

25 712158

24

1 BEARING

FLASQUE ROULT

LAGERFLANSCH

BEARING FLANGE

BEARING FLANGE

COUSSINET

LAGER

CUSCINETTO

COJINETE

26 ★ 70926838

➡ 190LB-50215

4 BOLT

BOULON

MASCH.SCHRAUBE

1/2"-13 X 1-1/2

BULLONE

ESPIGA/BULON

Chain Drive
 Transmission Par Chaîne
 Kettenantrieb
 Trasmisione A Catena
 Accionamiento Cadena

10-100

Right Side - From H.K 91221
 Cote Droit - A Partir Du H.K 91221
 Rechte Seite - Ab H.K 91221
 Lato Destro - Dalla H.K 91221
 Lado Derecho - Despues H.K 91221

5-BA25-049-A

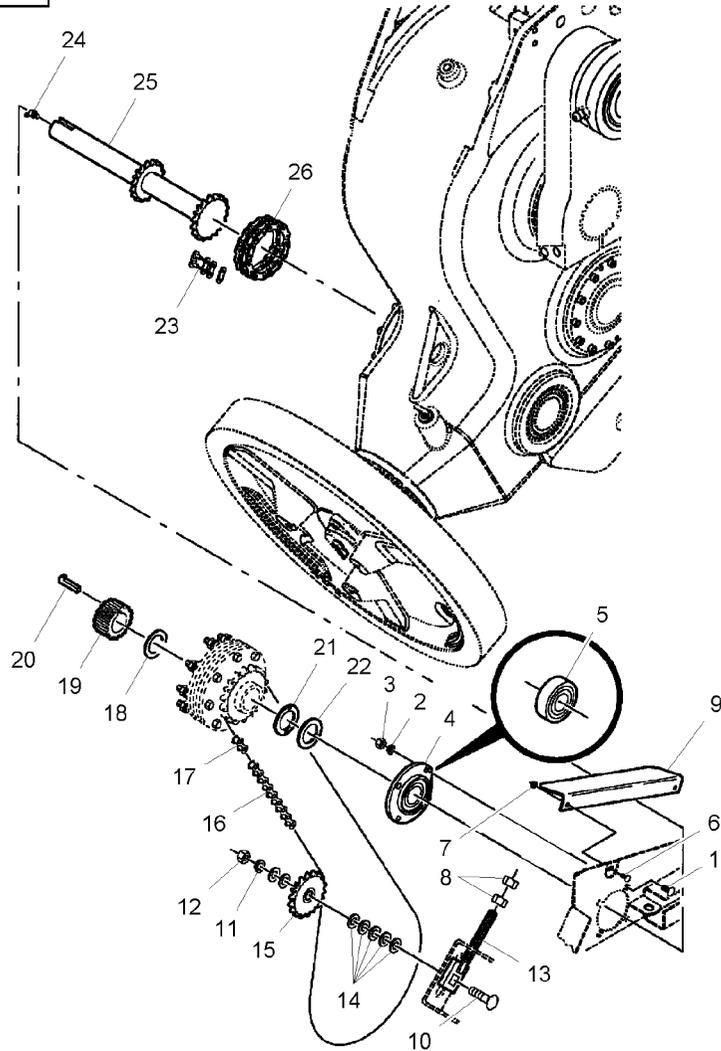

1★70926838	1/2"-13 X 1-1/2	4 BOLT	BOULON BULLONE	MASCH.SCHRAUBE ESPIGA/BULON
2★Y705046	1/2"	4 LOCK WASHER	RONDELLE FREIN	FEDERRING
3★704031	1/2"-13	4 NUT	ROSETTA DENTELL. ECROU	ARANDELA GROWER MUTTER
4★700109753P		1 BEARING FLANGE	DADO	TUERCA
5★712158	4	1 BEARING	FLASQUE ROULT BEARING FLANGE	LAGERFLANSCH BEARING FLANGE
6★70922786	3/8"-16 X 1	2 BOLT	COUSSINET CUSCINETTO	LAGER COJINETE
7★700711238	3/8"-16	2 LOCKNUT	BOULON BULLONE	MASCH.SCHRAUBE ESPIGA/BULON
8★70932665	5/8"-11	2 NUT	ECROU BLOCCAGE AUTOBLOCCANTE	SICHERUNGSMUTTER CONTRATUERCA
9★700139760		1 SHIELD	ECROU DADO	MUTTER TUERCA
10★364423X1	3/4"-10 X 3	1 BOLT	TOLE RIPARO	SCHILD BLINDAJE
11★70919332	3/4"	1 LOCK WASHER	BOULON BULLONE	MASCH.SCHRAUBE ESPIGA/BULON
12★70913160	3/4"-10	1 NUT	RONDELLE FREIN	FEDERRING
13★700112926P		1 BOLT	ROSETTA DENTELL. ECROU	ARANDELA GROWER MUTTER
14★Y705566	3/4"	7 WASHER	DADO BOULON	TUERCA MASCH.SCHRAUBE
15★700706110		1 SPROCKET	BULLONE RONDELLE	ESPIGA/BULON UNTERLEGSCHEIBE
16★W980268US	ASA 100H 10 FOOT BULK ASA100H-CONNECT	1 ROLL OF CHAIN	RONDELLA BARBOTIN	ARANDELA KETTENRAD
17★86405		1 LINK	RUOTA MOTRICE ROULEAU CHAINE	RUEDA DE CADENA KETTE METERWARE
17★3904530M91	ASA100H-CONNECT TYPE DIAMOND	1 LINK	RULLO PER CATENA	CADENA 5M
18★740407	2" X 10	1 BUSH	MAILLON MAGLIA	GLIED ENLACE
19★700112925		1 HUB	MAILLON MAGLIA	GLIED ENLACE
20★700706643		1 KEY	BAGUE BOCCOLA	BUCHSE CASQUILLO
21★8052177	2" X .125	1 BUSH	MOYEU MOZZO	NABE CUBO
22★852806	2" X .188	1 BUSH	CLAVETTE CHIAVETTA	PASSKEIL CLAVE
23★329278M91	ASA60-CONNECTOR	1 LINK	BAGUE BOCCOLA	BUCHSE CASQUILLO
23★329421M91	ASA60-OFFSET	1 CRANKED LINK	BAGUE BOCCOLA	BUCHSE CASQUILLO
24★70915275	1/8"-27 X 65°	1 GREASER	MAILLON MAGLIA	GLIED ENLACE
			MAILLON COUDE MAGLIA INCLINATA	GEKROEPTESGLIED UNION ACODADA
			GRAISSEUR INGRASSATORE	FETTNIPEL ENGRASADOR

Chain Drive
 Transmission Par Chaîne
 Kettenantrieb
 Trasmisione A Catena
 Accionamiento Cadena

10-100

Right Side - From H.K 91221
 Cote Droit - A Partir Du H.K 91221
 Rechte Seite - Ab H.K 91221
 Lato Destro - Dalla H.K 91221
 Lado Derecho - Despues H.K 91221

5-BA25-049-A

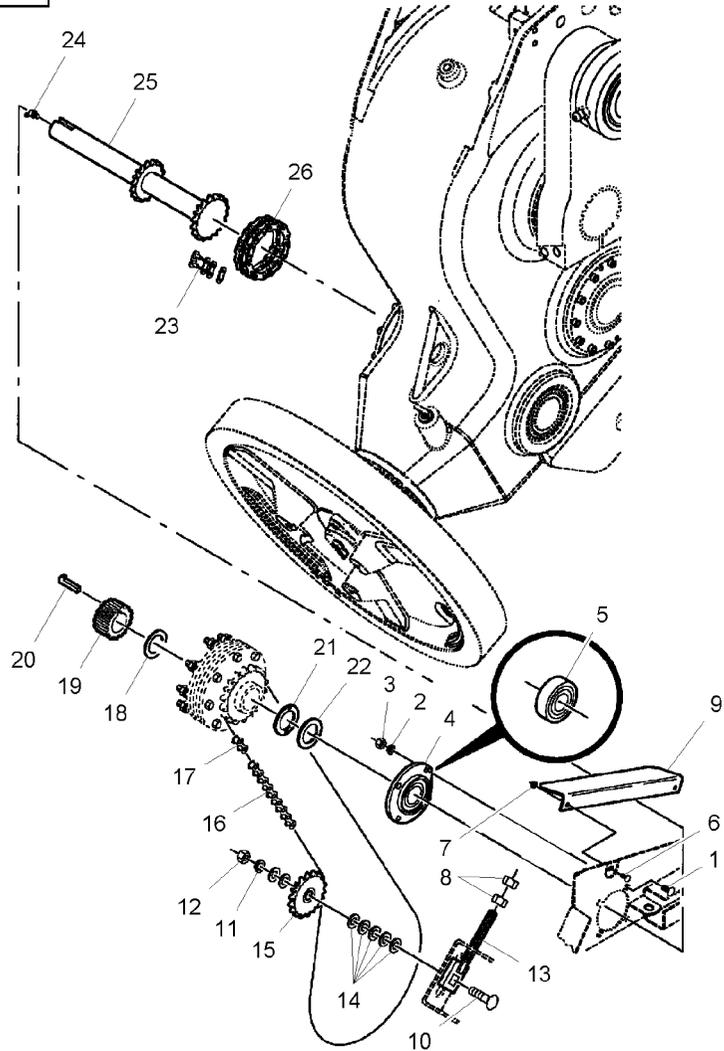

25* 700112919

1 SHAFT

ARBRE
 ALBERO
 CHAINE
 CATENA

WELLE
 ARBOL
 KETTE
 CADENA

26*

ASA60-18LINKS
 ▶ 3030181M91
 ◀ 5M

1 CHAIN

Chain Drive
 Transmission Par Chaîne
 Kettenantrieb
 Trasmissione A Catena
 Accionamiento Cadena

10-105

Clutch
 Embrayage
 Kupplung
 Frizione
 Embrague

5-BA25-010-C

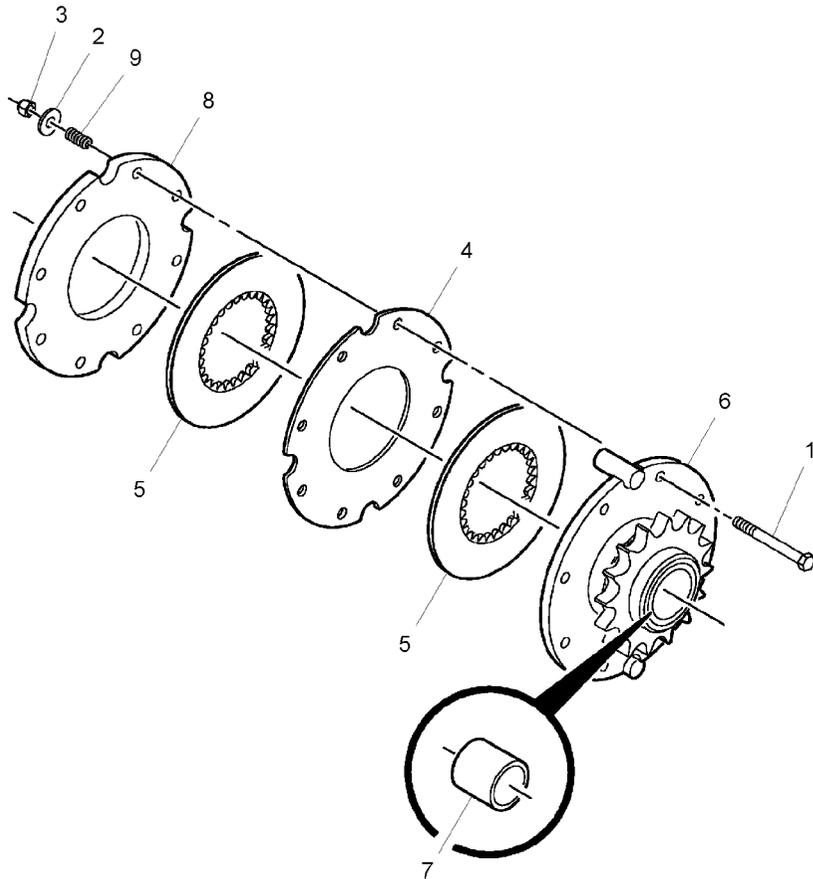

1	★70923938	3/8"-16 X 3-1/2	8	CAPSCREW	VIS BOUCHON	HUTSCHRAUBE
2	★70917378	3/8"	8	FLAT WASHERS	TAPPO A VITE	TORNILLO TAPON
3	★70919439	3/8"-16	8	NUT	RONDELLES PLATES	UNTERLEGSCHIEBEN
4	700112903P		1	PLATE	RONDELLE PIANA	ARANDELAS PLANAS
5	700108820		2	DISC	ECROU	MUTTER
6	700112899	→ HK 91220	1	SPROCKET	DADO	TUERCA
6	700138871P	→ HK 91221	1	SPROCKET	PLAQUE	PLATTE
7	6565030	→ HK 91221	1	BUSH	PIASTRA	PLATO
8	6522866P	→ HK 91221	8	SPRING	DISQUE	SCHEIBE
9	58107B	→ HK 91221			DISCO	DISCO
		→ HK 91220			BARBOTIN	KETTENRAD
		→ HK 91221			RUOTA MOTRICE	RUEDA DE CADENA
		→ HK 91221			BARBOTIN	KETTENRAD
		→ HK 91221			RUOTA MOTRICE	RUEDA DE CADENA
		→ HK 91221			BAGUE	BUCHSE
		→ HK 91221			BOCCOLA	CASQUILLO
		→ HK 91221			PLAQUE	PLATTE
		→ HK 91221			PIASTRA	PLATO
		→ HK 91221			RESSORT	FEDER
		→ HK 91221			MOLLA	RESORTE

--	--	--

20

Pick-Up
 Pick-Up
 Aufsammeltrommel
 Raccogliitore
 Recogedor

20-5

5-BA02-004-B

1 700113196

➡ 190LB-50100

1 PICKUP

PICK UP
 RECUPERO

PICKUP
 RECOGEDORA

1 700133677

➡ 190LB-50101

1 PICKUP

PICK UP
 RECUPERO

PICKUP
 RECOGEDORA

1 700134994

➡ 190LB-50146

1 PICKUP

PICK UP
 RECUPERO

PICKUP
 RECOGEDORA

1 700150622

➡ 190LB-50147

1 PICKUP

PICK UP
 RECUPERO

PICKUP
 RECOGEDORA

1 700138809

➡ 190LB-50214

1 PICKUP

PICK UP
 RECUPERO

PICKUP
 RECOGEDORA

➡ 190LB-50215

1 PICKUP

PICK UP
 RECUPERO

PICKUP
 RECOGEDORA

➡ HK 91220

1 PICKUP

PICK UP
 RECUPERO

PICKUP
 RECOGEDORA

➡ HK 91221

1 PICKUP

PICK UP
 RECUPERO

PICKUP
 RECOGEDORA

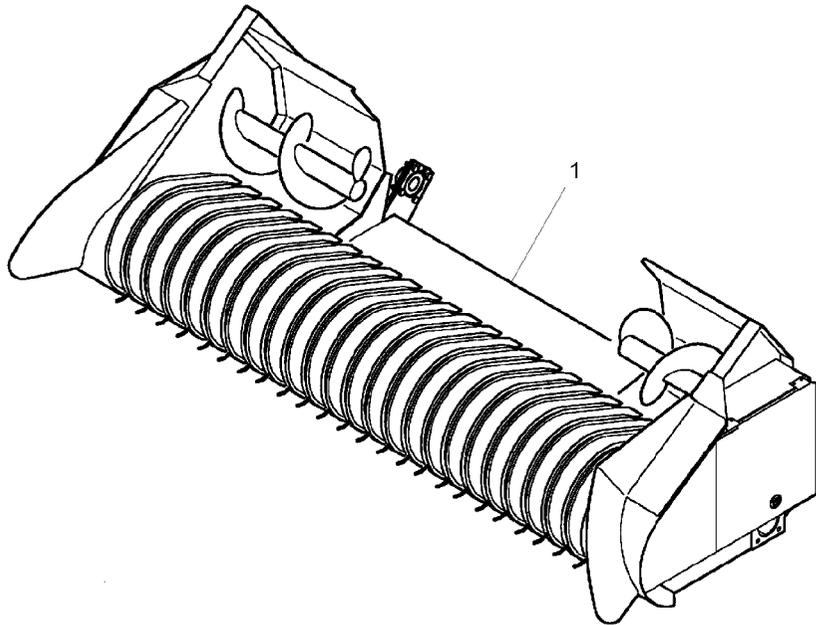

Pick-Up
 Pick-Up
 Aufsammeltrommel
 Raccogliitore
 Recogedor

20-10

5-BA02-005-B

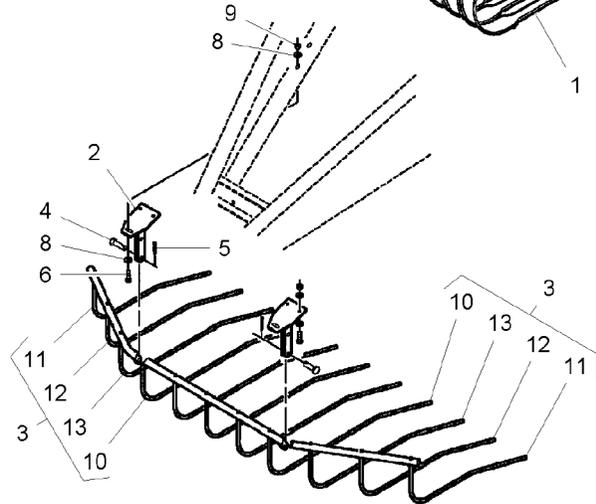
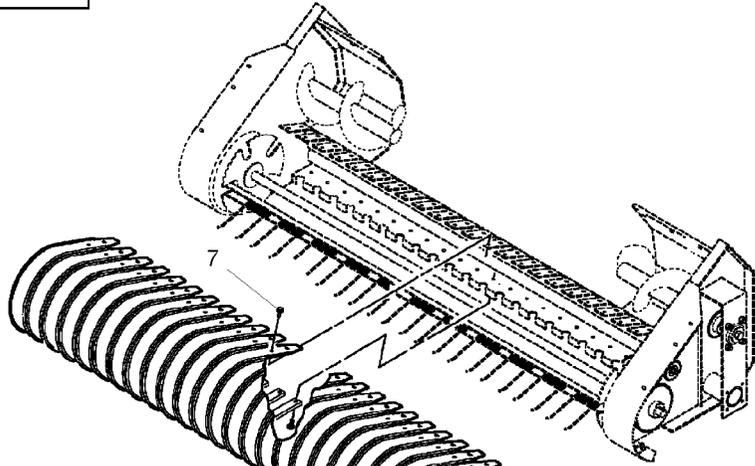

1	700113244P		25	WRAPPER	COUVERTURE	UMSCHLAG
2	700113625P		2	HANGER	IMBALLATORE	ENVASE
3	700113617P	➡ HK 91386	1	GUARD	POTENCE SUSPENS	AUFHAENGER
3*	700121638	➡ HK 91387	1	GUARD	SUPPORTO INCLIN.	COLGADOR
4	700708653	1/2" X 1-1/4	1	GUARD	GARDE	SCHUTZVORR
5*	70918452	1/8" X 1	1	GUARD	PROTEZIONE	DEFENSA
6*	70920415	3/8"-16 X 1-1/4	2	PIN	GARDE	SCHUTZVORR
7	7883325	5/16"-18 X 3/4	2	PIN	PROTEZIONE	DEFENSA
8	Y705533	3/8"	4	CAPSCREW	GOUILLE	BOLZEN
9	Y704734	3/8"-16	2	PIN	PERNO	PASADOR
10	700113619P		4	CAPSCREW	GOUILLE	BOLZEN
11	700113623P		50	SCREW	PERNO	PASADOR
12	700113622P		4	CAPSCREW	VIS BOUCHON	HUTSCHRAUBE
13	700113620P		8	WASHER	TAPPO A VITE	TORNILLO TAPON
			4	LOCKNUT	VIS	SCHRAUBE
			4	LOCKNUT	VITE	TORNILLO
			5	ROD	RONDELLE	UNTERLEGSCHIEBE
			2	ROD	RONDELLA	ARANDELA
			2	ROD	ECROU BLOCAGE	SICHERUNGSMUTTER
			2	ROD	AUTOBLOCCANTE	CONTRATUERCA
			2	ROD	TRINGLE	STANGE
			2	ROD	ASTA	VARILLA
			2	ROD	TRINGLE	STANGE
			2	ROD	ASTA	VARILLA
			2	ROD	TRINGLE	STANGE
			2	ROD	ASTA	VARILLA
			2	ROD	TRINGLE	STANGE
			2	ROD	ASTA	VARILLA

Chain Drive
 Transmission Par Chaîne
 Kettenantrieb
 Trasmisione A Catena
 Accionamiento Cadena

20-15

Left Side - Up To H.K 91220
 Cote Gauche - Jusqu'au H.K 91220
 Linke Seite - Bis H.K 91220
 Lato Sinistro - Fino Alla H.K 91220
 Lado Izquierdo - Hasta H.K 91220

5-BA25-012-C

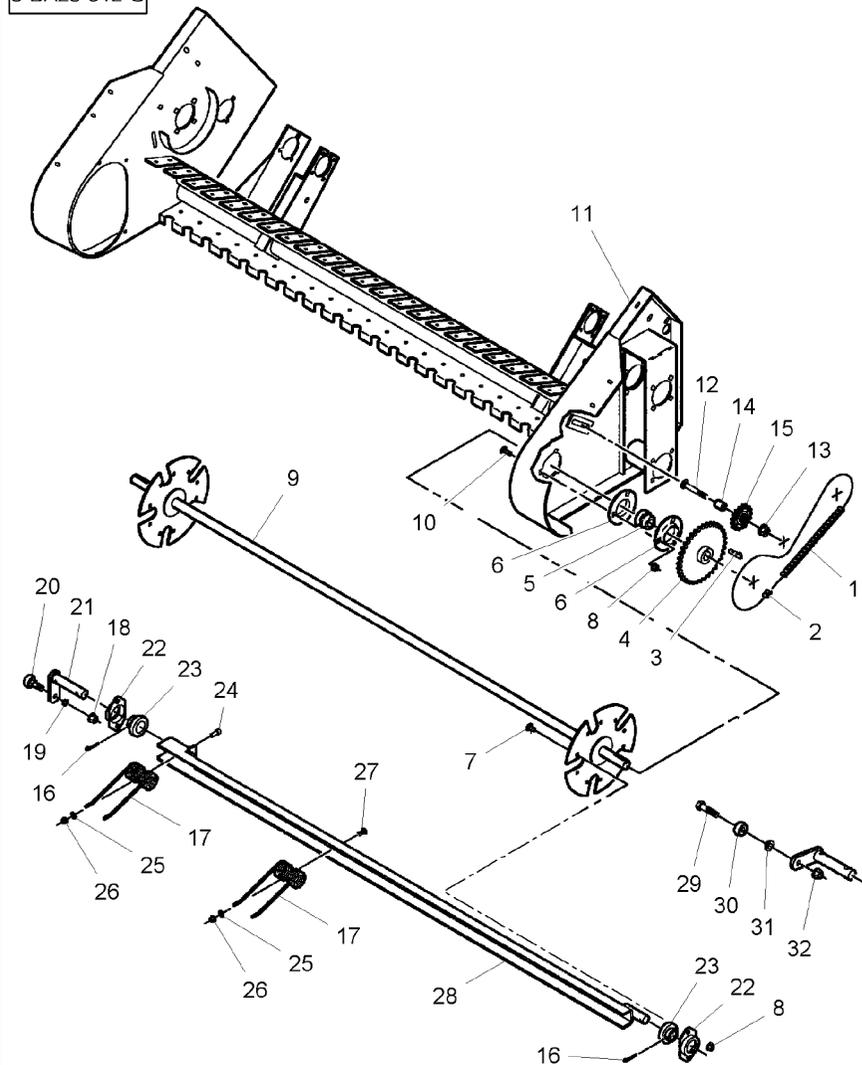

1	ASA50-84LINKS ▶ 1836103M91 ◀ 5M	1 CHAIN	CHAINE CATENA	KETTE CADENA
2	329264M91 ASA50-CONNECTOR	1 LINK	MAILLON MAGLIA	GLIED ENLACE
2	329266M91 ASA50-OFFSET	1 CRANKED LINK	MAILLON COUDE MAGLIA INCLINATA	GEKROEPFTESGLIED UNION ACODADA
3	Y61424 1/4" X 1-1/4	1 KEY	CLAVETTE CHIAVETTA	PASSKEIL CLAVE
4	6141311 36	1 SPROCKET	BARBOTIN RUOTA MOTRICE	KETTENRAD RUEDA DE CADENA
5	51292	1 BEARING	COUSSINET CUSCINETTO	LAGER COJINETE
6	051417P	2 FLANGE	FLASQUE FLANGIA	FLANSCH PLETINA
7	70922784 3/8"-16 X 3/4	20 BOLT	BOULON BULLONE	MASCH.SCHRAUBE ESPIGA/BULON
8	Y704734 ▶ 190LB-50146 3/8"-16	23 LOCKNUT	ECROU BLOCAGE AUTOBLOCCANTE	SICHERUNGSMUTTER CONTRATUERCA
8	700711238 ▶ 190LB-50147 3/8"-16	23 LOCKNUT	ECROU BLOCAGE AUTOBLOCCANTE	SICHERUNGSMUTTER CONTRATUERCA
9	700113229	1 REEL	RABATTEUR ASPO	HASPEL MOLINETE
10	70922786 3/8"-16 X 1	3 BOLT	BOULON BULLONE	MASCH.SCHRAUBE ESPIGA/BULON
11	700113199 ▶ 190LB-50100	1 PICKUP	PICK UP RECUPERO	PICKUP RECOGEDORA
11	700133673 ▶ 190LB-50101	1 PICKUP	PICK UP RECUPERO	PICKUP RECOGEDORA
11	700134970 ▶ 190LB-50146	1 PICKUP	PICK UP RECUPERO	PICKUP RECOGEDORA
11	700134970 ▶ 190LB-50147	1 PICKUP	PICK UP RECUPERO	PICKUP RECOGEDORA
11	700134970 ▶ 190LB-50214	1 PICKUP	PICK UP RECUPERO	PICKUP RECOGEDORA
11	700150626 ▶ 190LB-50215	1 PICKUP	PICK UP RECUPERO	PICKUP RECOGEDORA
12	70931813 1/2"-13 X 3-1/2	1 BOLT	BOULON BULLONE	MASCH.SCHRAUBE ESPIGA/BULON
13	Y704742 ▶ 190LB-50100 1/2"-13	1 LOCKNUT	ECROU BLOCAGE AUTOBLOCCANTE	SICHERUNGSMUTTER CONTRATUERCA
13	700714586 ▶ 190LB-50101 1/2"-13	1 NUT	ECROU DADO	MUTTER TUERCA
14	6530638P	1 BUSH	BAGUE BOCCOLA	BUCHSE CASQUILLO
15	47142 17	1 SPROCKET	BARBOTIN RUOTA MOTRICE	KETTENRAD RUEDA DE CADENA
16	62307 1/4" X 2	10 PIN	GOUPILLE PERNO	BOLZEN PASADOR
17	700714199B 60	TINE	DENT A RESSORT DENTE ELASTICO	ZINKE DIENTE
18	702700045 ▶ 190LB-50214	5 NUT	ECROU DADO	MUTTER TUERCA
19	Y705046 ▶ 190LB-50214 1/2"	5 LOCK WASHER	RONDELLE FREIN ROSETTA DENTELL.	FEDERRING ARANDELA GROWER

Chain Drive
 Transmission Par Chaîne
 Kettenantrieb
 Trasmisione A Catena
 Accionamiento Cadena

20-15

Left Side - Up To H.K 91220
 Cote Gauche - Jusqu'au H.K 91220
 Linke Seite - Bis H.K 91220
 Lato Sinistro - Fino Alla H.K 91220
 Lado Izquierdo - Hasta H.K 91220

5-BA25-012-C

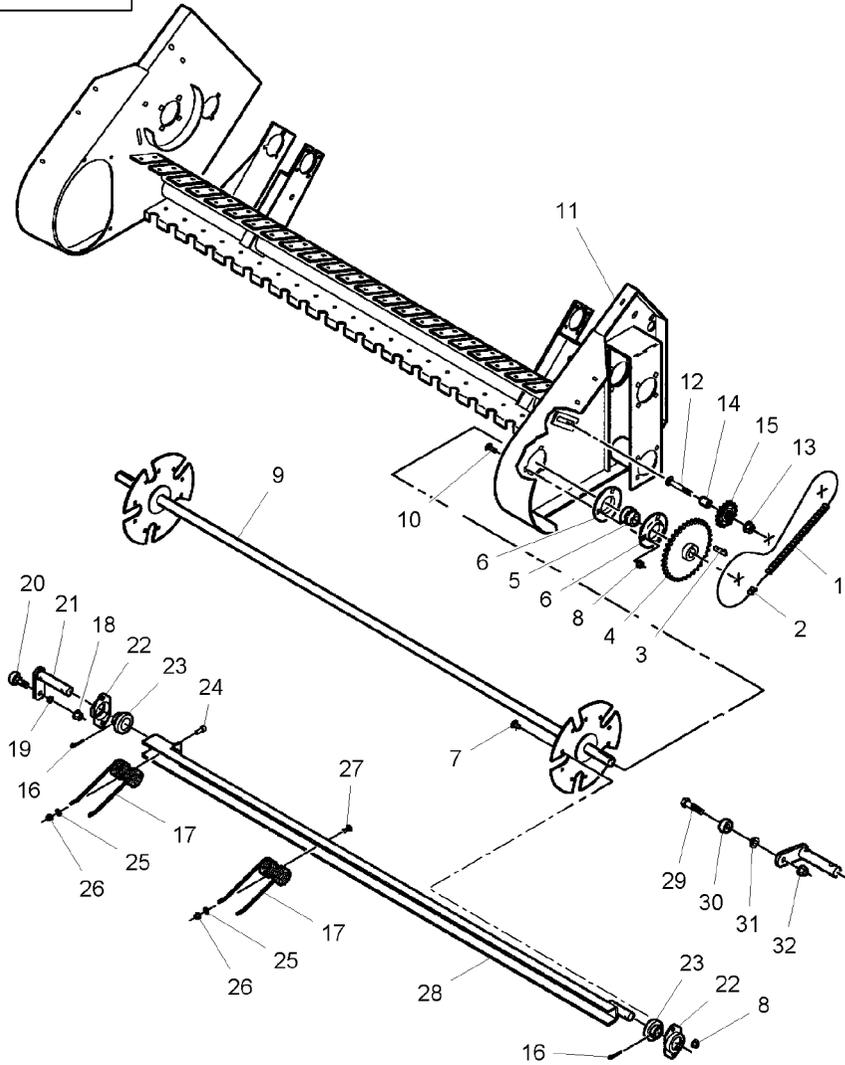

20	700705612	➡ 190LB-50214	5 BEARING	COUSSINET CUSCINETTO	LAGER COJINETE
21	700113239		5 CRANK	MANIVELLE MANOVELLA	KURBEL MANIVELA
22	700108622P		10 BEARING FLANGE	FLASQUE ROULT BEARING FLANGE	LAGERFLANSCH BEARING FLANGE
23	Y710392		10 BEARING	COUSSINET CUSCINETTO	LAGER COJINETE
24	70912269	3/8"-16 X 2	5 CAPSCREW	VIS BOUCHON TAPPO A VITE	HUTSCHRAUBE TORNILLO TAPON
25	Y705533	3/8"	60 WASHER	RONDELLE RONDELLA	UNTERLEGSCHIEBE ARANDELA
26	Y704734	3/8"-16	60 LOCKNUT	ECROU BLOCAGE AUTOBLOCCANTE	SICHERUNGSMUTTER CONTRATUERCA
27	70922786	3/8"-16 X 1	55 BOLT	BOULON BULLONE	MASCH.SCHRAUBE ESPIGA/BULON
28	700113235		5 CHANNEL	CANAL PROFILATO	KANAL CANAL
29	700716158	➡ 190LB-50215 1/2"-20 X 2	5 SCREW	VIS VITE	SCHRAUBE TORNILLO
30	700720050	➡ 190LB-50215	5 BEARING	COUSSINET CUSCINETTO	LAGER COJINETE
31	700137750P	➡ 190LB-50215	5 SPACER	ENTRETOISE DISTANZIALE	ABSTANDSTUECK DISCO ESPACIADOR
32	700707867	➡ 190LB-50215 1/2"-20	5 LOCKNUT	ECROU BLOCAGE AUTOBLOCCANTE	SICHERUNGSMUTTER CONTRATUERCA

Chain Drive
 Transmission Par Chaîne
 Kettenantrieb
 Trasmisione A Catena
 Accionamiento Cadena

20-20

Left Side - From H.K 91221
 Cote Gauche - A Partir Du H.K 91221
 Linke Seite - Ab H.K 91221
 Lato Sinistro - Dalla H.K 91221
 Lado Izquierdo - A Partir Del H.K 91221

5-BA25-032-B

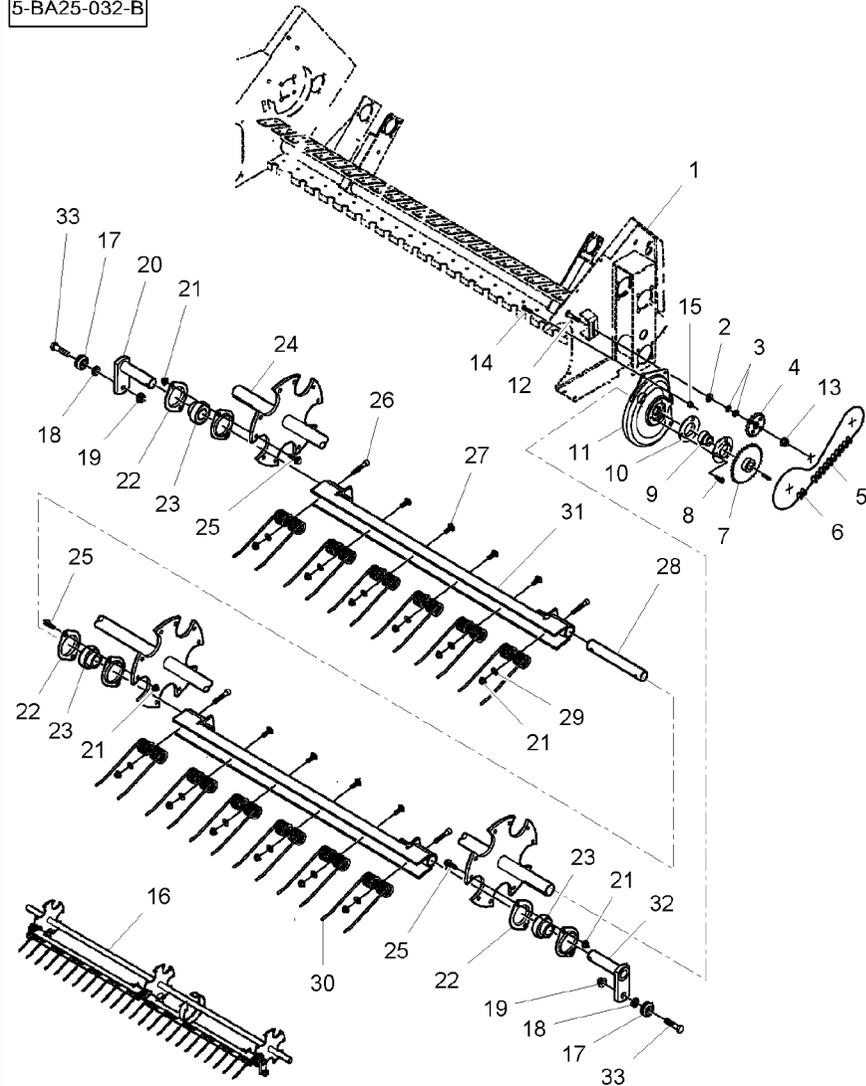

25★7883408	16 3/8"-16 X 1-1/4	30 SCREW	VIS	SCHRAUBE
26★70912269	16 3/8"-16 X 2	20 CAPSCREW	VITE	TORNILLO
27★70922786	16 3/8"-16 X 2	40 BOLT	VIS BOUCHON	HUTSCHRAUBE
28★700138835P	16	5 SHAFT	TAPPO A VITE	TORNILLO TAPON
29★Y705533	16 3/8"	60 WASHER	BOULON	MASCH.SCHRAUBE
30★700714199B	16	60 TINE	BULLONE	ESPIGA/BULON
31★700138830P	16	10 CHANNEL	ARBRE	WELLE
32★700138829P	16 ◀	5 CRANK	ALBERO	ARBOL
33★700716158	16 1/2"-20 X 2	10 SCREW	RONDELLE	UNTERLEGSCHIEBE
			RONDELLA	ARANDELA
			DENT A RESSORT	ZINKE
			DENTE ELASTICO	DIENTE
			CANAL	KANAL
			PROFILATO	CANAL
			MANIVELLE	KURBEL
			MANOVELLA	MANIVELA
			VIS	SCHRAUBE
			VITE	TORNILLO

Chain Drive
Transmission Par Chaîne
Kettenantrieb
Trasmissione A Catena
Accionamiento Cadena

20-25

Right Side
Cote Droit
Rechte Seite
Lato Destro
Lado Derecho

5-BA25-011-C

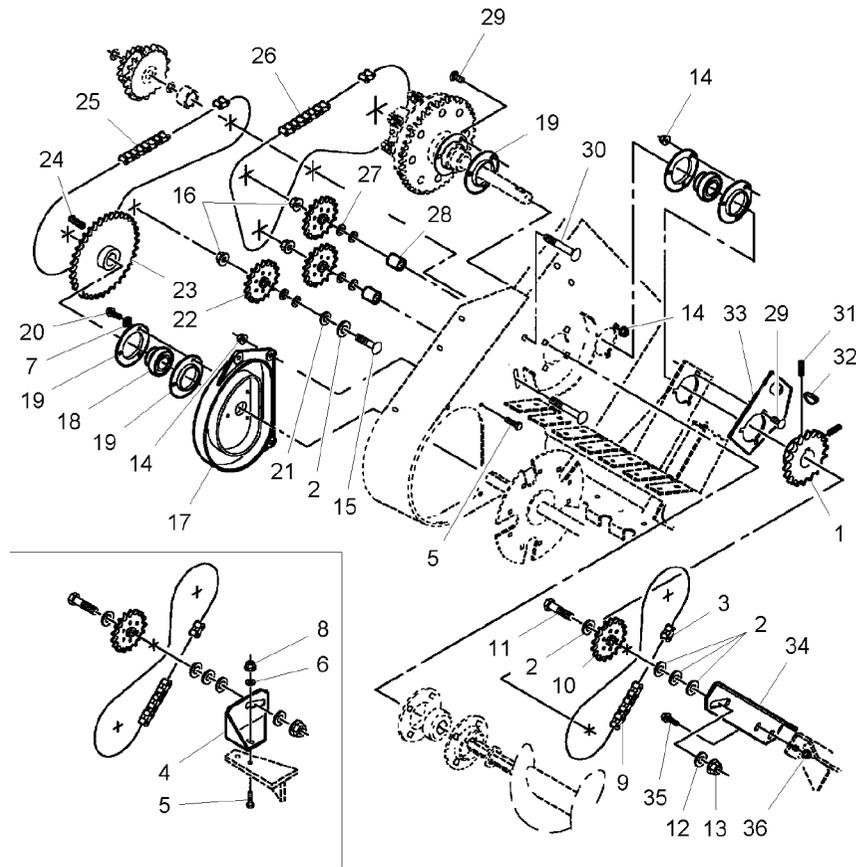

1	7047541	18	1	SPROCKET	BARBOTIN RUOTA MOTRICE	KETTENRAD RUEDA DE CADENA
2	Y705582	5/8"	6	WASHER	RONDELLE RONDELLA	UNTERLEGSCHIEBE ARANDELA
3	329277M91	ASA60-CONNECTOR	1	LINK	MAILLON MAGLIA	GLIED ENLACE
3	329420M91	ASA60-OFFSET	1	CRANKED LINK	MAILLON COUDE MAGLIA INCLINATA	GEKROEPFTESGLIED UNION ACODADA
4	700113291	190LB-50146	1	SUPPORT	SUPPORT SUPPORTO	LAGERUNG DISPOS.DE SOSTEN
4	700113291	190LB-50215 HK 91220	1	SUPPORT	SUPPORT SUPPORTO	LAGERUNG DISPOS.DE SOSTEN
5	70920415	3/8"-16 X 1-1/4	5	CAPSCREW	VIS BOUCHON TAPPO A VITE	HUTSCHRAUBE TORNILLO TAPON
6	Y705533	3/8"	2	WASHER	RONDELLE RONDELLA	UNTERLEGSCHIEBE ARANDELA
7	70916965	3/8"	5	LOCK WASHER	RONDELLE FREIN ROSETTA DENTELL.	FEDERRING ARANDELA GROWER
8	70916950	3/8"-16	2	NUT	ECROU DADO	MUTTER TUERCA
9	ASA60-44LINKS 1836104M91 5M 15		1	CHAIN	CHAINE CATENA	KETTE CADENA
10	87726		1	IDLER	POULIE TENSION RUOTA FOLLE	LEITRAD POLEA LOCA
11	353729X1	5/8"-11 X 2-1/2	1	BOLT UNC	BOULON UNC BULLONE UNC	MASCH.SCHRB.UNC PERNO UNC
12	70917373	5/8"	1	LOCK WASHER	RONDELLE FREIN ROSETTA DENTELL.	FEDERRING ARANDELA GROWER
13	70932665	190LB-50146 5/8"-11	1	NUT	ECROU DADO	MUTTER TUERCA
13	700703922	190LB-50147 5/8"-11	1	LOCKNUT	ECROU BLOCAGE AUTOBLOCCANTE	SICHERUNGSMUTTER CONTRATUERCA
14	Y704734	3/8"-16	9	LOCKNUT	ECROU BLOCAGE AUTOBLOCCANTE	SICHERUNGSMUTTER CONTRATUERCA
15	70927493	1/2"-13 X 2-1/2	1	BOLT	BOULON BULLONE	MASCH.SCHRAUBE ESPIGA/BULON
16	Y704742	190LB-50146 1/2"-13	3	LOCKNUT	ECROU BLOCAGE AUTOBLOCCANTE	SICHERUNGSMUTTER CONTRATUERCA
16	700714586	190LB-50147 1/2"-13	3	NUT	ECROU DADO	MUTTER TUERCA
17	700113645	190LB-50146	1	CAM	CAME CAMMA	NOCKEN LEVA
17	700138846P	190LB-50147 190LB-50214	1	CAM	CAME CAMMA	NOCKEN LEVA
17	700113645	190LB-50215 HK 91220	1	CAM	CAME CAMMA	NOCKEN LEVA
17	700138846P	HK 91221	1	CAM	CAME CAMMA	NOCKEN LEVA
18	51292	190LB-50146	2	BEARING	COUSSINET CUSCINETTO	LAGER COJINETE

Chain Drive
 Transmission Par Chaîne
 Kettenantrieb
 Trasmisione A Catena
 Accionamiento Cadena

20-25

Right Side
 Cote Droit
 Rechte Seite
 Lato Destro
 Lado Derecho

5-BA25-011-C

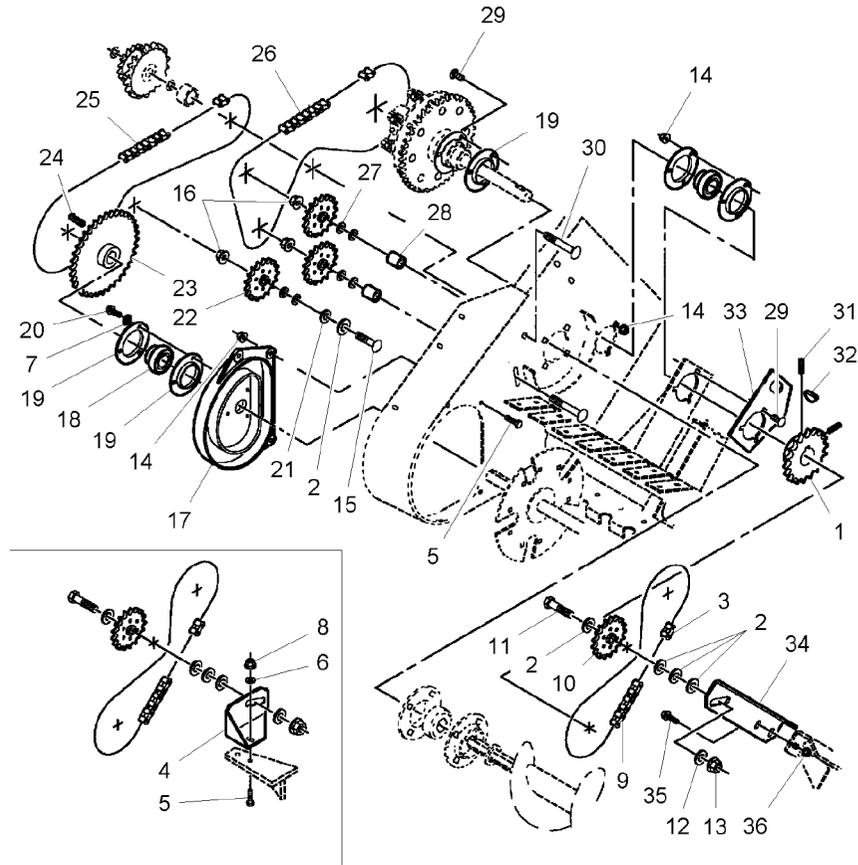

29	70922786	3/8"-16 X 1	6 BOLT	BOULON	MASCH.SCHRAUBE
30	★70931813	1/2"-13 X 3-1/2	2 BOLT	BULLONE	ESPIGA/BULON
31	69427	3/8"-16 X 5/8	2 SETSCREW	BOULON	MASCH.SCHRAUBE
32	70911020	1/4" X 1-1/4	1 KEY	BULLONE	ESPIGA/BULON
33	700113297P	➡ 190LB-50100	1 SHIELD	VIS DE BLOCAGE	STELLSCHRAUBE
33	700133725	➡ 190LB-50101	1 SHIELD	INSIEME VITI	SET SCREW
33	700113297P	➡ 190LB-50146	1 SHIELD	CLAVETTE	PASSKEIL
34	★700138876P	➡ 190LB-50147	1 SUPPORT	CHIAVETTA	CLAVE
35	368270X1	➡ 190LB-50147	2 SCREW	TOLE	SCHILD
36	Y704734	➡ 190LB-50147	2 LOCKNUT	RIPARO	BLINDAJE
		➡ 3/8"-16 X 1-1/4		TOLE	SCHILD
		➡ 3/8"-16		RIPARO	BLINDAJE
				SUPPORT	LAGERUNG
				SUPPORTO	DISPOS.DE SOSTEN
				VIS	SCHRAUBE
				VITE	TORNILLO
				ECROU BLOCAGE	SICHERUNGSMUTTER
				AUTOBLOCCANTE	CONTRATUERCA

Clutch
Embrayage
Kupplung
Frizione
Embraque

20-30

Pickup
Pickup
Pickup
Recupero
Recogedora

5-BA18-005-C

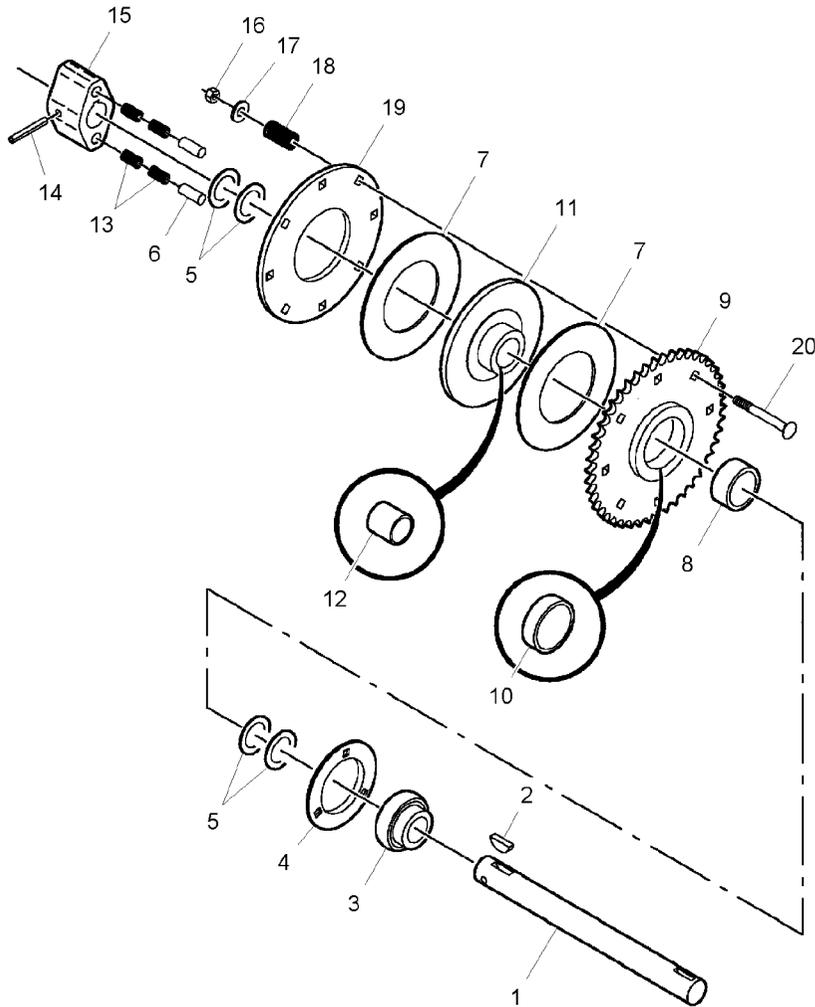

1	700113260		1	SHAFT	ARBRE	WELLE
2	70905129		1	KEY	ALBERO	ARBOL
3	51292		1	BEARING	CLAVETTA	PASSKEIL
4	051417P		1	FLANGE	CHIAVETTA	CLAVE
5	Y740068	1"-1/4 X 18	4	BUSH	COUSSINET	LAGER
6	63800	1/2" X 1-1/4	2	PIN	CUSCINETTO	COJINETE
7	700711025		2	DISC	FLASQUE	FLANSCH
8	6549588P		1	SPACER	FLANGIA	PLETINA
9	700113254P	43	1	SPROCKET	BAGUE	BUCHSE
10	6564975	9	1	BEARING	BOCCOLA	CASQUILLO
11	700113259P		2	DISC	GOUPILLE	BOLZEN
12	6564983	11	1	CLUTCH	PERNO	PASADOR
13	58511		2	DISC	DISQUE	SCHIEBE
14	70916016	5/16" X 2-1/4	1	SPACER	DISCO	DISCO
15	6522668P		1	SPACER	ENTRETOISE	ABSTANDSTUECK
16	★70919439	3/8"-16	1	SPROCKET	DISTANZIALE	DISCO ESPACIADOR
17	★70917378	3/8"	1	BEARING	BARBOTIN	KETTENRAD
18	58107B		1	BEARING	RUOTA MOTRICE	RUEDA DE CADENA
19	700113257P		1	CLUTCH	COUSSINET	LAGER
20	★70931359	3/8"-16 X 3-1/2	1	CLUTCH	CUSCINETTO	COJINETE
			1	CLUTCH	EMBAYAGE	SCHALKUPPLUNG
			1	BUSH	FRIZIONE	EMBRAGUE
			4	COMP.SP. SPRING	BAGUE	BUCHSE
			1	PIN	BOCCOLA	CASQUILLO
			1	HUB	RESSORT DE COMPR	DRUCKFEDER
			8	NUT	MOLLA COMPOSTA	RESORTE DE COMP.
			8	FLAT WASHERS	GOUPILLE	BOLZEN
			8	SPRING	PERNO	PASADOR
			1	PLATE	MOYEU	NABE
			8	BOLT	MOZZO	CUBO
					ECROU	MUTTER
					DADO	TUERCA
					RONDELLES PLATES	UNTERLEGSCHIEBEN
					RONDELLE PIANA	ARANDELAS PLANAS
					RESSORT	FEDER
					MOLLA	RESORTE
					PLAQUE	PLATTE
					PIASTRA	PLATO
					BOULON	MASCH.SCHRAUBE
					BULLONE	ESPIGA/BULON

Pick-Up
Pick-Up
Aufsammeltrommel
Raccogliore
Recogedor

20-35

➔ 190LB-50146

5-BA02-007-C

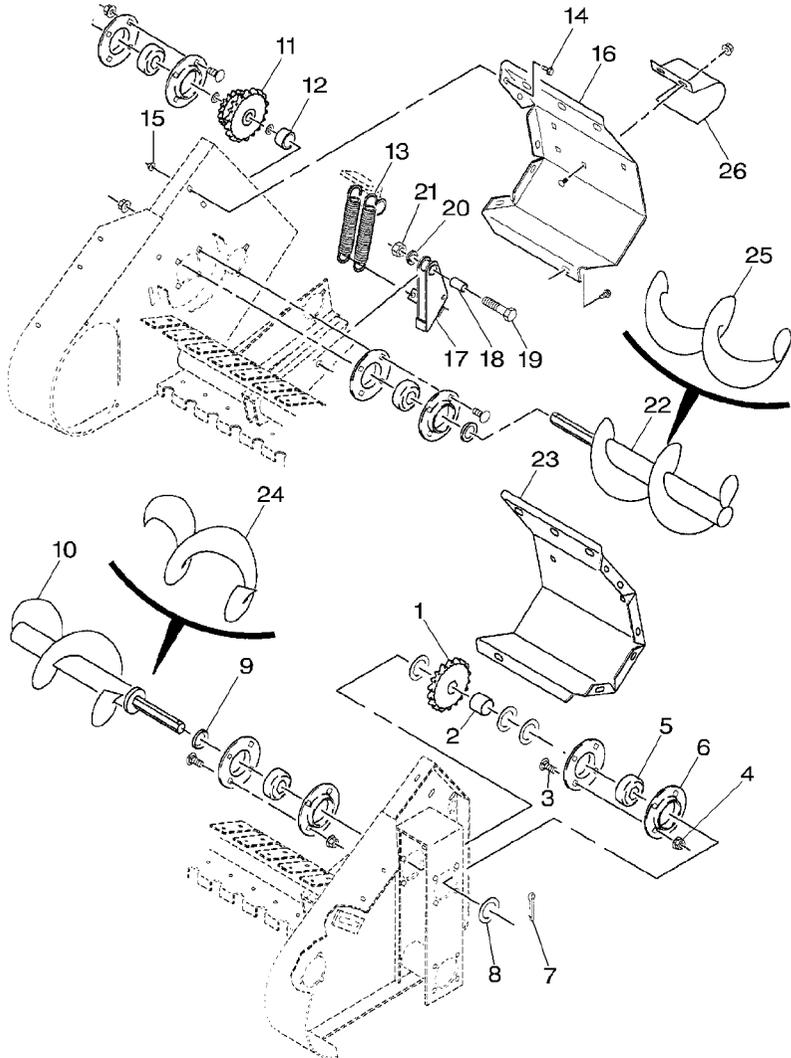

1	700113643P	20	1	SPROCKET	BARBOTIN	KETTENRAD
2	700113304P		1	SPACER	RUOTA MOTRICE	RUEDA DE CADENA
3	★68619	1/2"-13 X 1-1/4			ENTRETOISE	ABSTANDSTUECK
4	Y704742	1/2"-13	16	BOLT	DISTANZIALE	DISCO ESPACIADOR
5	70575883				BOULON	MASCH.SCHRAUBE
6	★050575P		16	LOCKNUT	BULLONE	ESPIGA/BULON
7	★62463	1/4" X 1-3/4	4	BALL BEARING	ECROU BLOCAGE	SICHERUNGSMUTTER
8	Y52282	1"-1/2 X14			AUTOBLOCCANTE	CONTRATUERCA
9	700113638P				ROULEMENT BILLES	KUGELLAGER
10	700113299P				CUSCINETTO SFERE	COJINETE DE BOLA
11	700113636P	20/29	8	FLANGE	FLASQUE	FLANSCH
12	700113305P				FLANGIA	PLETINA
13	858308		2	PIN	GOUPILLE	BOLZEN
14	7883325	5/16"-18 X 3/4			PERNO	PASADOR
15	70931277	5/16"-18	7	BUSH	BAGUE	BUCHSE
16	700113270				BOCCOLA	CASQUILLO
17	700113276		2	SPACER	ENTRETOISE	ABSTANDSTUECK
18	700113281P		1	AUGER	DISTANZIALE	DISCO ESPACIADOR
19	★70925707	3/4"-10 X 3			VIS SANS FIN	FOERDERSCHNECKE
20	★70919332	3/4"	1	SPROCKET	COCLEA	SINFIN
21	★70913160	3/4"-10	1	SPROCKET	BARBOTIN	KETTENRAD
22	700113300P		1	SPACER	RUOTA MOTRICE	RUEDA DE CADENA
23	700113269		1	SPACER	ENTRETOISE	ABSTANDSTUECK
24	700113248		2	SPRING	DISTANZIALE	DISCO ESPACIADOR
25	700113247				RESSORT	FEDER
26	700121668P				MOLLA	RESORTE
			13	SCREW	VIS	SCHRAUBE
					VITE	TORNILLO
			13	NUT	ECROU	MUTTER
					DADO	TUERCA
			1	PANEL	PANNEAU	VERKL.BLECH
			1	PIVOT	PANNELLO	PANELAJE
					PIVOT	DREHZAPFEN
					CARDINE	PIVOTE
			1	SPACER	ENTRETOISE	ABSTANDSTUECK
			1	CAPSCREW	DISTANZIALE	DISCO ESPACIADOR
					VIS BOUCHON	HUTSCHRAUBE
			1	LOCK WASHER	TAPPO A VITE	TORNILLO TAPON
					RONDELLE FREIN	FEDERRING
			1	NUT	ROSETTA DENTELL.	ARANDELA GROWER
					ECROU	MUTTER
			1	AUGER	DADO	TUERCA
					VIS SANS FIN	FOERDERSCHNECKE
			1	PANEL	COCLEA	SINFIN
					PANNEAU	VERKL.BLECH
			1	FLIGHT	PANNELLO	PANELAJE
					VOL	LATTE
			1	FLIGHT	VOLO	ASPA
					VOL	LATTE
					VOLO	ASPA
			1	SHIELD	TOLE	SCHILD
					RIPARO	BLINDAJE

Pick-Up
Pick-Up
Aufsammeltrommel
Raccogliitore
Recogedor

20-40

➔ 190LB-50147

5-BA02-014-C

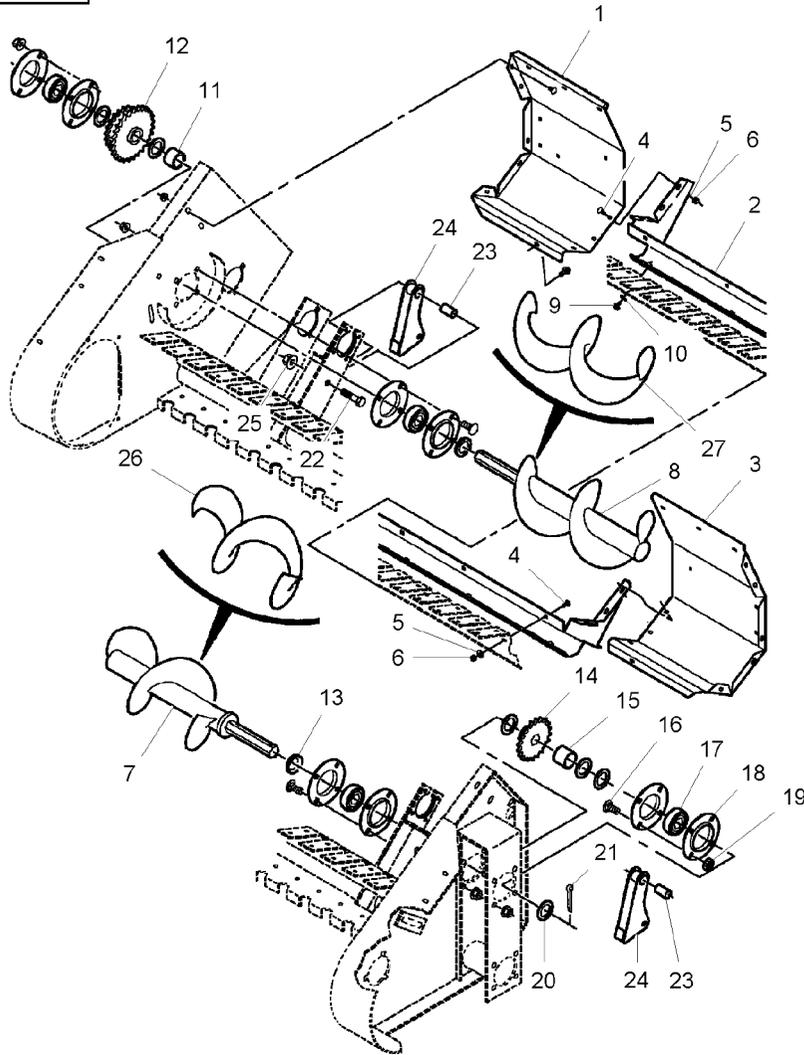

1	700134986P	▶	1	AUGER	VIS SANS FIN	FOERDERSCHNECKE
2	700134978P		1	PICKUP	COCLEA	SINFIN
3	700134985P	◀	1	AUGER	PICK UP	PICKUP
4	★7700461	5/16"-18 X 3/4	23	BOLT	RECUPERO	RECOGEDORA
5	Y705525	5/16"	23	WASHER	VIS SANS FIN	FOERDERSCHNECKE
6	70931277	5/16"-18	23	NUT	COCLEA	SINFIN
7	700113299P	◀	1	AUGER	BOULON	MASCH.SCHRAUBE
8	700113300P	▶	1	AUGER	BULLONE	ESPIGA/BULON
9	7883382	3/8"-16 X 1	5	SCREW	RONDELLE	UNTERLEGSCHIEBE
10	Y705533	3/8"	5	WASHER	RONDELLA	ARANDELA
11	700113305P		1	SPACER	ECROU	MUTTER
12	700113636P	⚙ 20/29	1	SPROCKET	DADO	TUERCA
13	700113638P		2	SPACER	VITE	FOERDERSCHNECKE
14	700113643P	⚙ 20	1	SPROCKET	COCLEA	SINFIN
15	700113304P		1	SPACER	VIS SANS FIN	FOERDERSCHNECKE
16	★68619	1/2"-13 X 1-1/4	16	BOLT	COCLEA	SINFIN
17	70575883		4	BALL BEARING	COCLEA	SINFIN
18	★050575P		8	FLANGE	VIS	SCHRAUBE
19	700714586	1/2"-13	16	NUT	VITE	TORNILLO
20	Y52282	1"-1/2 X 1/4	5	WASHER	RONDELLE	UNTERLEGSCHIEBE
21	★62463	1/4" X 1-3/4	1	SPACER	RONDELLA	ARANDELA
22	★70924741	3/4"-10 X 3-1/4	1	SPACER	ENTRETOISE	ABSTANDSTUECK
23	700113281P		1	SPROCKET	DISTANZIALE	DISCO ESPACIADOR
24	700134963P		2	PIVOT	BARBOTIN	KETTENRAD
25	700703923	3/4"-10	2	LOCKNUT	RUOTA MOTTRICE	RUEDA DE CADENA
26	700113248	▶	1	FLIGHT	ENTRETOISE	ABSTANDSTUECK
			2	SPACER	DISTANZIALE	DISCO ESPACIADOR
			2	PIVOT	BARBOTIN	KETTENRAD
			2	PIVOT	RUOTA MOTTRICE	RUEDA DE CADENA
			2	LOCKNUT	ENTRETOISE	ABSTANDSTUECK
			2	LOCKNUT	DISTANZIALE	DISCO ESPACIADOR
			2	LOCKNUT	PIVOT	DREHZAPFEN
			2	LOCKNUT	CARDINE	PIVOTE
			2	LOCKNUT	ECROU BLOCAGE	SICHERUNGSMUTTER
			1	FLIGHT	AUTOBLOCCANTE	CONTRATUERCA
			1	FLIGHT	VOL	LATTE
			1	FLIGHT	VOLO	ASPA

Pick-Up
Pick-Up
Aufsammeltrommel
Raccoglitore
Recogedor

20-40

➔ 190LB-50147

5-BA02-014-C

27 700113247

1 FLIGHT

VOL
VOLO

LATTE
ASPA

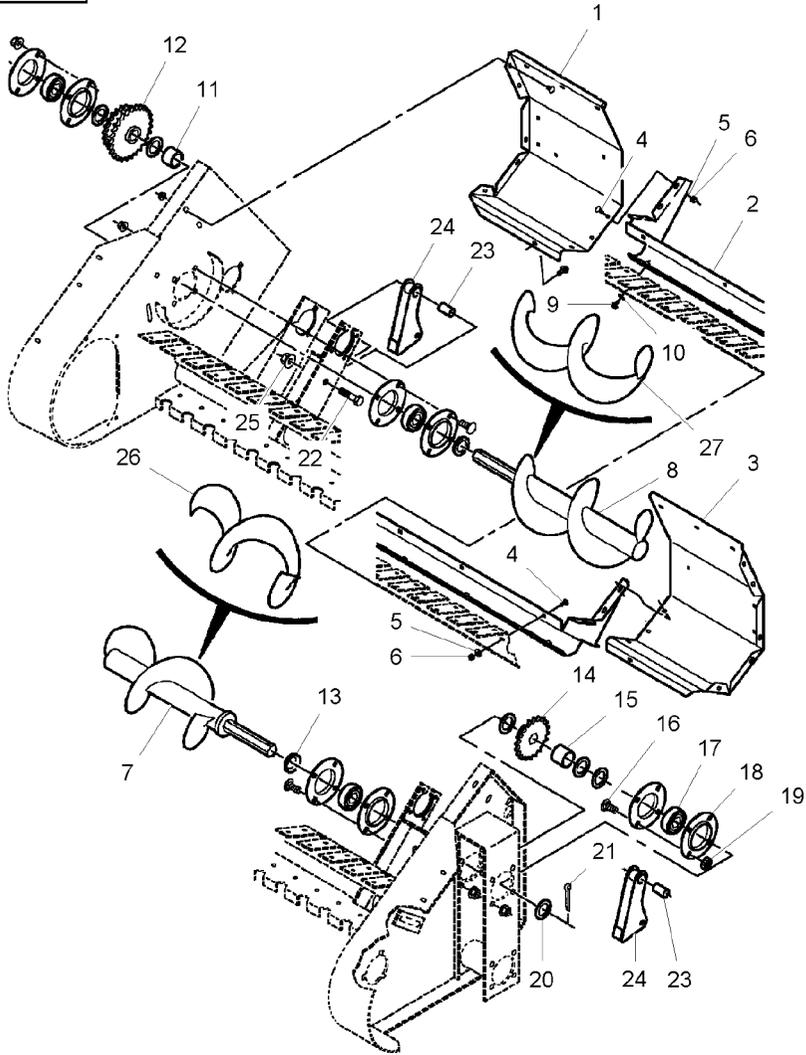

Shields
Garants
Schutzbleche
Difese
Proteccionee

20-45

Pickup
Pickup
Pickup
Recupero
Recogedora

5-BA17-009-E

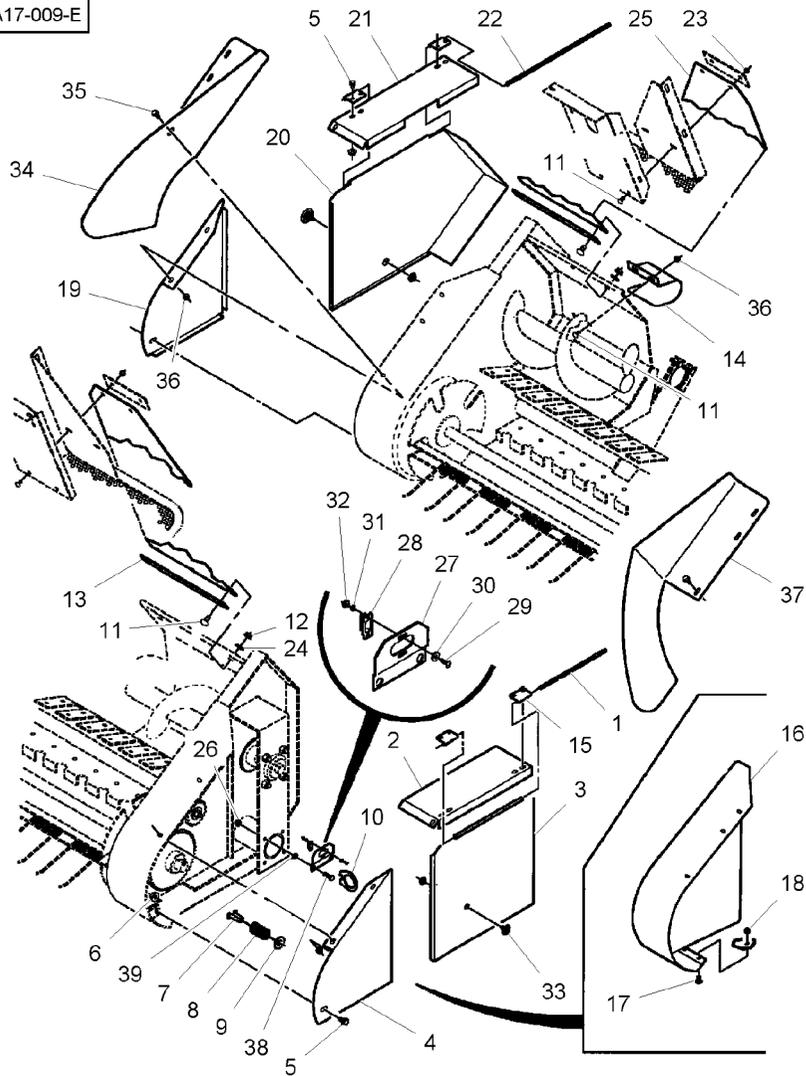

1	278523	➡	190LB-50100	1 BUSH	BAGUE	BUCHSE
1	317818	➡	190LB-50101	1 PIN	BOCCOLA	CASQUILLO
2	700114002P	▲		1 CHANNEL	GOUPILLE	BOLZEN
3	700114004	➡	190LB-50100	1 SHIELD	PERNO	PASADOR
3	700133679P	➡	190LB-50101	1 SHIELD	CANAL	KANAL
4	700150652	▲		1 SHIELD	PROFILATO	CANAL
5	7883317	5/16"-18 X 1/2		20 SCREW	TOLE	SCHILD
6	70931277	5/16"-18		20 NUT	RIPARO	BLINDAJE
7	7894975	➡	190LB-50100	2 CLIP	TOLE	SCHILD
8	7758212	➡	190LB-50100	2 SPRING	RIPARO	BLINDAJE
9	Y705525	➡	190LB-50100	2 WASHER	TOLE	SCHILD
10	7894967	➡	190LB-50100	2 HANDLE	RIPARO	BLINDAJE
11	7700461	5/16"-18 X 3/4		12 BOLT	TOLE	SCHILD
12	70931277	5/16"-18		6 NUT	RIPARO	BLINDAJE
13	700121498P			2 STRAP	TOLE	SCHILD
14	700121668P			1 SHIELD	FERMAGLIO	CLIP
15	700163299			4 SUPPORT	RESSORT	FEDER
16	700138840P	➡	HK 91221	1 GUARD	MOLLA	RESORTE
17	7770456	➡	HK 91221	2 BOLT	RONDELLE	UNTERLEGSCHIEBE
18	700711238	➡	HK 91221	2 LOCKNUT	RONDELLA	ARANDELA
19	700150653P	▲		1 SHIELD	POIGNEE	HANDGRIFF
20	700114005	➡	190LB-50100	1 SHIELD	MANIGLIA	MANETA
20	700133680P	➡	190LB-50101	1 SHIELD	BOULON	MASCH.SCHRAUBE
21	700114003P	▲		1 CHANNEL	BULLONE	ESPIGA/BULON
22	700114019	▲		1 HINGE	ECROU BLOCAGE	SICHERUNGSMUTTER
23	Y704163	5/16"-18		4 NUT	AUTOBLOCCANTE	CONTRATUERCA
		▲			TOLE	SCHILD
		▲			RIPARO	BLINDAJE
		▲			TOLE	SCHILD
		▲			RIPARO	BLINDAJE
		▲			TOLE	SCHILD
		▲			RIPARO	BLINDAJE
		▲			CANAL	KANAL
		▲			PROFILATO	CANAL
		▲			CHARNIERE	SCHARNIER
		▲			CERNIERA	BISAGRA
		▲			ECROU	MUTTER
		▲			DADO	TUERCA

Shields
Garants
Schutzbleche
Difese
Proteccionee

20-45

Pickup
Pickup
Pickup
Recupero
Recogedora

5-BA17-009-E

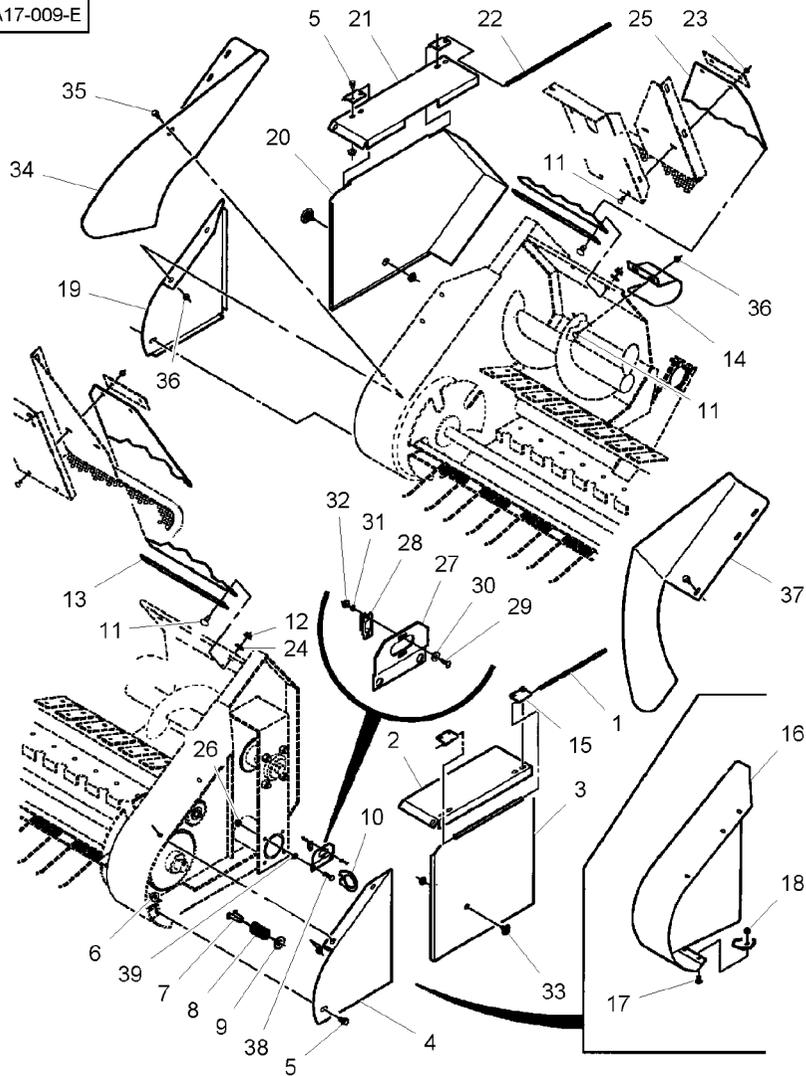

24	Y705525	5/16"	6	WASHER	RONDELLE	UNTERLEGSCHIEBE
25	700709850				RONDELLA	ARANDELA
26	Y704742	1/2"-13	2	SHIELD	TOLE	SCHILD
27	700133681P				RIPARO	BLINDAJE
28	700714529		4	LOCKNUT	ECROU BLOCAGE	SICHERUNGSMUTTER
29	700700628	No 10-24 X 1/2	2	SUPPORT	AUTOBLOCCANTE	CONTRATUERCA
30	70917380	No 10			SUPPORTO	LAGERUNG
31	353445X1	No 10			SUPPORTO	DISPOS.DE SOSTEN
32	★354120X1	No 10-24	2	RECEIVER	RECEVEUR	EMPFANGER
33	700714528		4	SCREW	RICEVITORE	RECEPTOR
34	★700138239	▶			VIS	SCHRAUBE
35	7883325	5/16"-18 X 3/4			VITE	TORNILLO
36	70931277	5/16"-18			RONDELLE	UNTERLEGSCHIEBE
37	★700138238	◀	4	WASHER	RONDELLA	ARANDELA
38	★701235	1/2"-13 X 1-1/2	4	LOCK WASHER	RONDELLE FREIN	FEDERRING
39	705541	1/2"	4	NUT	ROSETTA DENTELL.	ARANDELA GROWER
			2	LATCH	ECROU	MUTTER
			1	SHIELD	DADO	TUERCA
			3	SCREW	VERROU	RIEGEL
					CHIAVISTELLO	CERROJO
			1	SHIELD	TOLE	SCHILD
			3	NUT	RIPARO	BLINDAJE
					VIS	SCHRAUBE
					VITE	TORNILLO
			1	SHIELD	ECROU	MUTTER
					DADO	TUERCA
					TOLE	SCHILD
			4	BOLT	RIPARO	BLINDAJE
					BOULON	MASCH.SCHRAUBE
					BULLONE	ESPIGA/BULON
					RONDELLE	UNTERLEGSCHIEBE
					RONDELLA	ARANDELA

Pick-Up
Pick-Up
Aufsammeltrommel
Raccoglitore
Recogedor

20-50

Suspension - Up To 190lb-50146
Suspension - Jusqu'au 190lb-50146
Federung - Bis 190lb-50146
Sospensione - Fino All 190lb-50146
Suspension - Hasta 190lb-50146

5-BA02-006-C

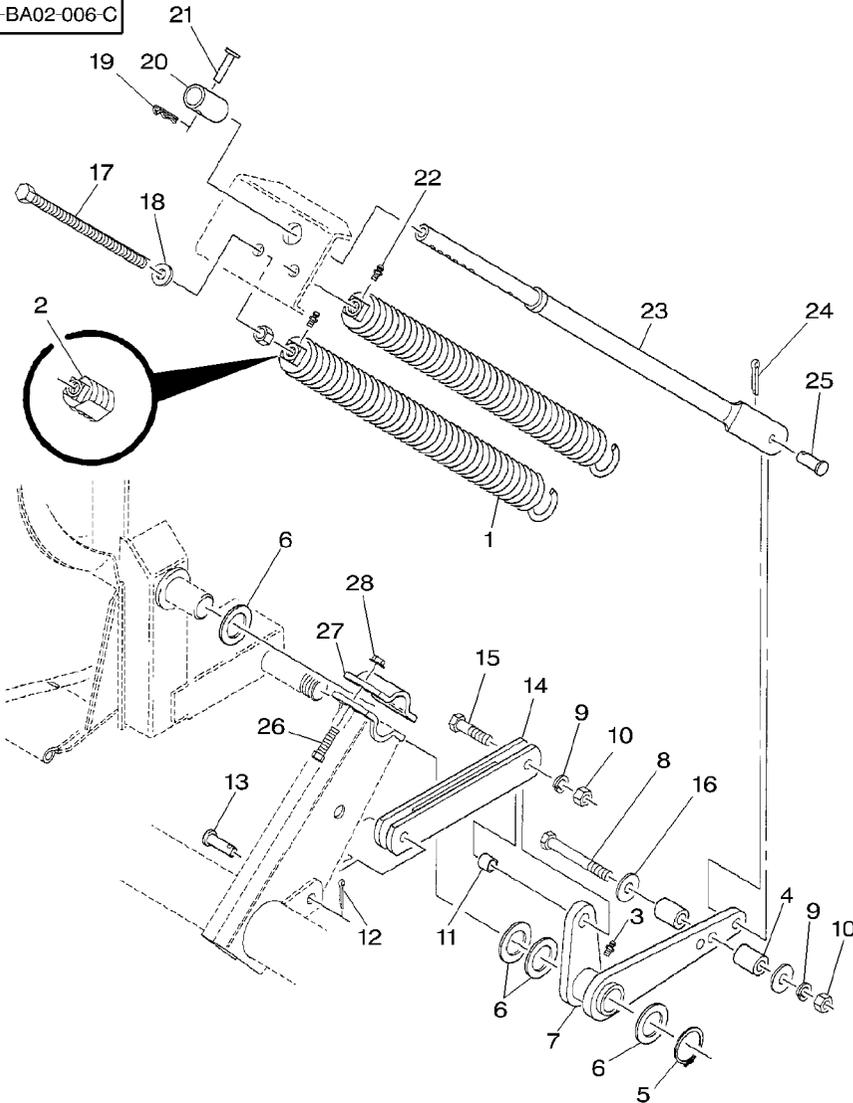

1	6522700P		2	SPRING	RESSORT	FEDER
2	6845879P	1	2	PLUG	MOLLA	RESORTE
3	70914465	[A]			BOUCHON	VERSCHL.STOPFEN
4	6229462P	1/8"-27	1	GREASE NIPPLE	TAPPO	TAPON
5	1003115M1		1	GREASE NIPPLE	GRAISSEUR DROIT	FETT-NIPPEL
6	740522	1"-1/2 X 10	2	SPACER	INGRASSAT.	ENGRASADOR
7	700113283		2	SPACER	ENTRETOISE	ABSTANDSTUECK
8	70929030		1	RING	DISTANZIALE	DISCO ESPACIADOR
8★	70925705	190LB-50100	1	RING	ANNEAU	RING
9★	70917373	190LB-50101	5	BUSH	ANELLO	ARO
10★	70932665	5/8"-11	1	BUSH	BAGUE	BUCHSE
11	159723		1	CRANK	BOCCOLA	CASQUILLO
12★	70918452	1/8" X 1	1	CRANK	MANIVELLE	KURBEL
13	863498	5/8" X 3-1/2	1	CRANK	MANOVELLA	MANIVELA
14	700113287P		1	CAPSCREW	VIS BOUCHON	HUTSCHRAUBE
15★	353729X1	5/8"-11 X 2-1/2	1	CAPSCREW	TAPPO A VITE	TORNILLO TAPON
16★	70918432	5/8"	1	CAPSCREW	VIS BOUCHON	HUTSCHRAUBE
17	Y702282	5/8"-11 X 10	1	CAPSCREW	TAPPO A VITE	TORNILLO TAPON
18	Y705582	5/8"	2	LOCK WASHER	RONDELLE FREIN	FEDERRING
19	70936348	.120"	1	LOCK WASHER	ROSETTA DENTELL.	ARANDELA GROWER
20	700113296P		4	NUT	ECROU	MUTTER
21	863381	3/8" X 2	1	NUT	DADO	TUERCA
22	70923219	1/4"-28	1	SPACER	ENTRETOISE	ABSTANDSTUECK
23	700113292P		1	SPACER	DISTANZIALE	DISCO ESPACIADOR
24★	62117	1/8" X 1-1/4	1	PIN	GOUPILLE	BOLZEN
25	863753	5/8" X 1-3/4	1	PIN	PERNO	PASADOR
			1	CLEVIS PIN	AXE	SPLINTBOLZEN
			1	LINK	PERNO D'ATTACCO	BULON CILINDRICO
			1	LINK	MAILLON	GLIED
			1	BOLT UNC	MAGLIA	ENLACE
			1	BOLT UNC	BOULON UNC	MASCH.SCHRB.UNC
			2	WASHER	BULLONE UNC	PERNO UNC
			2	WASHER	RONDELLE	UNTERLEGSCHIEBE
			2	WASHER	RONDELLE	ARANDELA
			1	PIN	RONDELLE	SCHRAUBE
			2	WASHER	GOUPILLE	TORNILLO
			1	PIN	PERNO	UNTERLEGSCHIEBE
			1	COLLAR	RONDELLE	ARANDELA
			1	CLEVIS PIN	GOUPILLE	BOLZEN
			2	GREASER	PERNO	PASADOR
			1	LINK	COLLERETTE	KRAGEN
			1	LINK	COLLARE	COLLARIN
			1	LINK	AXE	SPLINTBOLZEN
			1	LINK	PERNO D'ATTACCO	BULON CILINDRICO
			1	PIN	GRAISSEUR	FETTNIPEL
			1	PIN	INGRASSATORE	ENGRASADOR
			1	PIN	MAILLON	GLIED
			1	PIN	MAGLIA	ENLACE
			1	PIN	GOUPILLE	BOLZEN
			1	PIN	PERNO	PASADOR
			1	PIN	GOUPILLE	BOLZEN
			1	PIN	PERNO	PASADOR

Pick-Up
 Pick-Up
 Aufsammeltrommel
 Raccoglitore
 Recogedor

20-50

Suspension - Up To 190lb-50146
 Suspension - Jusqu'au 190lb-50146
 Federung - Bis 190lb-50146
 Sospensione - Fino All 190lb-50146
 Suspensión - Hasta 190lb-50146

5-BA02-006-C

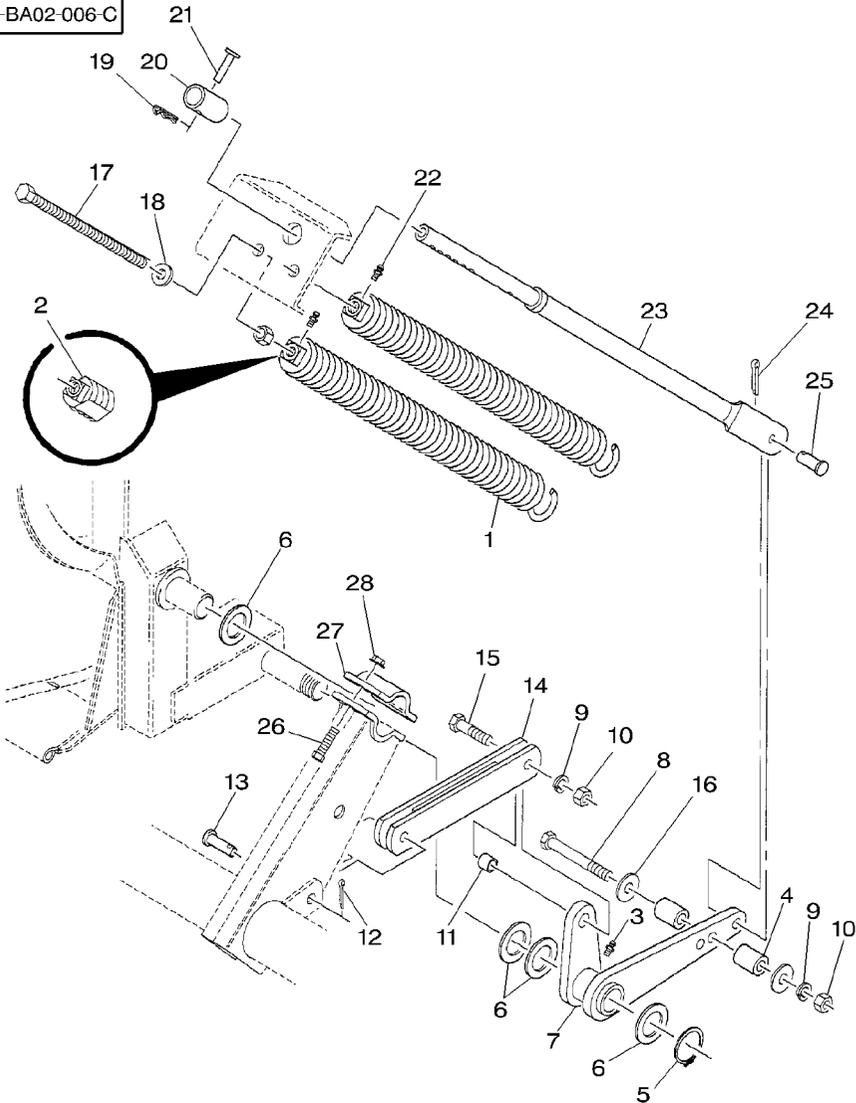

26	70923154	1/2" - 13 X 1-1/2	4 CAPSCREW
27	700113206		2 SUPPORT
28	Y704742	1/2" - 13	4 LOCKNUT

VIS BOUCHON	HUTSCHRAUBE
TAPPO A VITE	TORNILLO TAPON
SUPPORT	LAGERUNG
SUPPORTO	DISPOS.DE SOSTEN
ECROU BLOCCAGE	SICHERUNGSMUTTER
AUTOBLOCCANTE	CONTRATUERCA

[A] USED ONLY ON UNIT WITHOUT CENTRALIZED LUBRICATION SYSTEM
 UTILISE A DEFAUT DE LUBRIFICATION CENTRALISE
 VERWENDEN WENN KEINE ZENTRALSCHMIERUNG
 UTIZZARE SE NON LUBRIFICAZIONE CENTRALE
 USAR SI NO ENGRASE CENTRAL

Pick-Up
Pick-Up
Aufsammeltrommel
Raccoglitore
Recogedor

20-55

Suspension - From 190lb-50147
Suspension - A Partir Du 190lb-50147
Federung - Ab 190lb-50147
Sospensione - Dalla 190lb-50147
Suspension - A Partir Del 190lb-50147

5-BA02-020-B

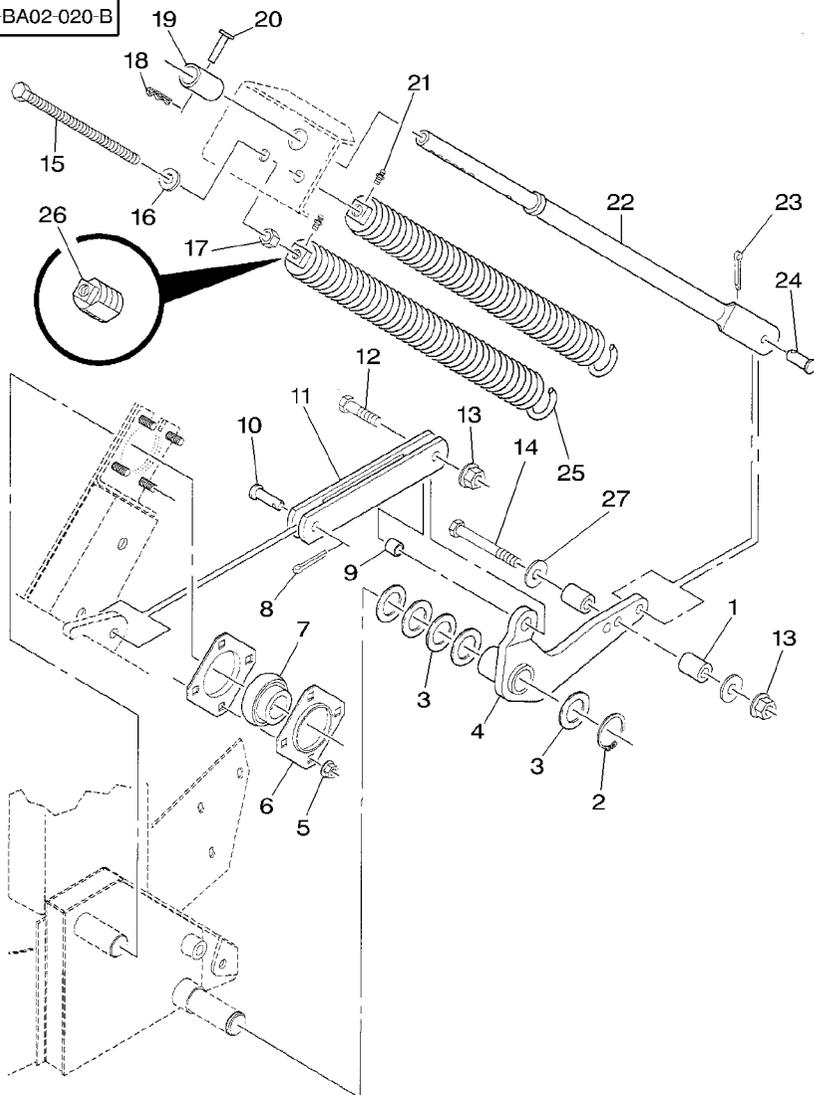

1	6229462P		2	SPACER	ENTRETOISE	ABSTANDSTUECK
2	1003115M1			DISTANZIALE	DISCO ESPACIADOR	
3	Y52282	1"-1/2 X 14	1	RING	ANNEAU	RING
4	700134966P			ANELLO	ARO	
5	Y704742	1/2"-13	5	BUSH	BAGUE	BUCHSE
6	700711918			BOCCOLA	CASQUILLO	
7	71122510		1	CRANK	MANIVELLE	KURBEL
8	★70918452	1/8" X 1		MANOVELLA	MANIVELA	
9	700134398		8	LOCKNUT	ECROU BLOCAGE	SICHERUNGSMUTTER
10	63693	5/8" X 2		AUTOBLOCCANTE	CONTRATUERCA	
11	700113287P		4	FLANGE	FLASQUE	FLANSCH
12	★353729X1	5/8"-11 X 2-1/2		FLANGIA	PLETINA	
13	700703922	5/8"-11	2	BEARING FLANGE	FLASQUE ROULT	LAGERFLANSCH
14	★70925705	5/8"-11 X 5		BEARING FLANGE	GOUPILLE	BEARING FLANGE
15	Y702282	5/8"-11 X 10	1	PIN	PERNO	BOLZEN
16	Y705582	5/8"		PASADOR	ENTRETOISE	PASADOR
17	★70932665	5/8"-11	1	SPACER	DISTANZIALE	ABSTANDSTUECK
18	70936348			GOUPILLE	DISCO ESPACIADOR	BOLZEN
19	700113296P		1	PIN	GOUPILLE	PASADOR
20	863381	3/8" X 2		PERNO	TAPPO A VITE	HUTSCHRAUBE
21	70923219	1/4"-28	2	SCREW	VITE	TORNILLO TAPON
22	700113292P			WASHER	RONDELLE	SCHRAUBE
23	★62117	1/8" X 1-1/4			RONDELLA	TORNILLO
24	863753	5/8" X 1-3/4	2	NUT	ECROU	UNTERLEGSCHIEBE
25	6522700P				DADO	ARANDELA
26	6845879P	25	2	LOCKNUT	ECROU BLOCAGE	MUTTER
					AUTOBLOCCANTE	TUERCA
			1	CAPSCREW	VIS BOUCHON	BOLZEN
					TAPPO A VITE	PASADOR
			2	SCREW	VITE	KRAGEN
					RONDELLE	COLLARIN
			2	WASHER	RONDELLA	COLLARE
					ECROU	AXE
			1	NUT	DADO	PERNO D'ATTACCO
					GOUPILLE	GRAISSEUR
			1	PIN	PERNO	INGRASSATORE
					COLLERETTE	MAILLON
			1	COLLAR	COLLARE	MAGLIA
					AXE	GOUPILLE
			1	CLEVIS PIN	PERNO D'ATTACCO	PERNO
					GRAISSEUR	GOUPILLE
			2	GREASER	INGRASSATORE	PERNO
					MAILLON	GOUPILLE
			1	LINK	MAGLIA	PERNO
					GOUPILLE	GOUPILLE
			1	PIN	PERNO	PERNO
					GOUPILLE	PERNO
			1	PIN	PERNO	PASADOR
					RESSORT	BOLZEN
			2	SPRING	MOLLA	PASADOR
					BOUCHON	FEDER
			2	PLUG	TAPPO	RESORTE
						VERSCHL.STOPFEN
						TAPON

Pick-Up
Pick-Up
Aufsammeltrommel
Raccogliitore
Recogedor

20-55

Suspension - From 190lb-50147
Suspension - A Partir Du 190lb-50147
Federung - Ab 190lb-50147
Sospensione - Dalla 190lb-50147
Suspension - A Partir Del 190lb-50147

5-BA02-020-B

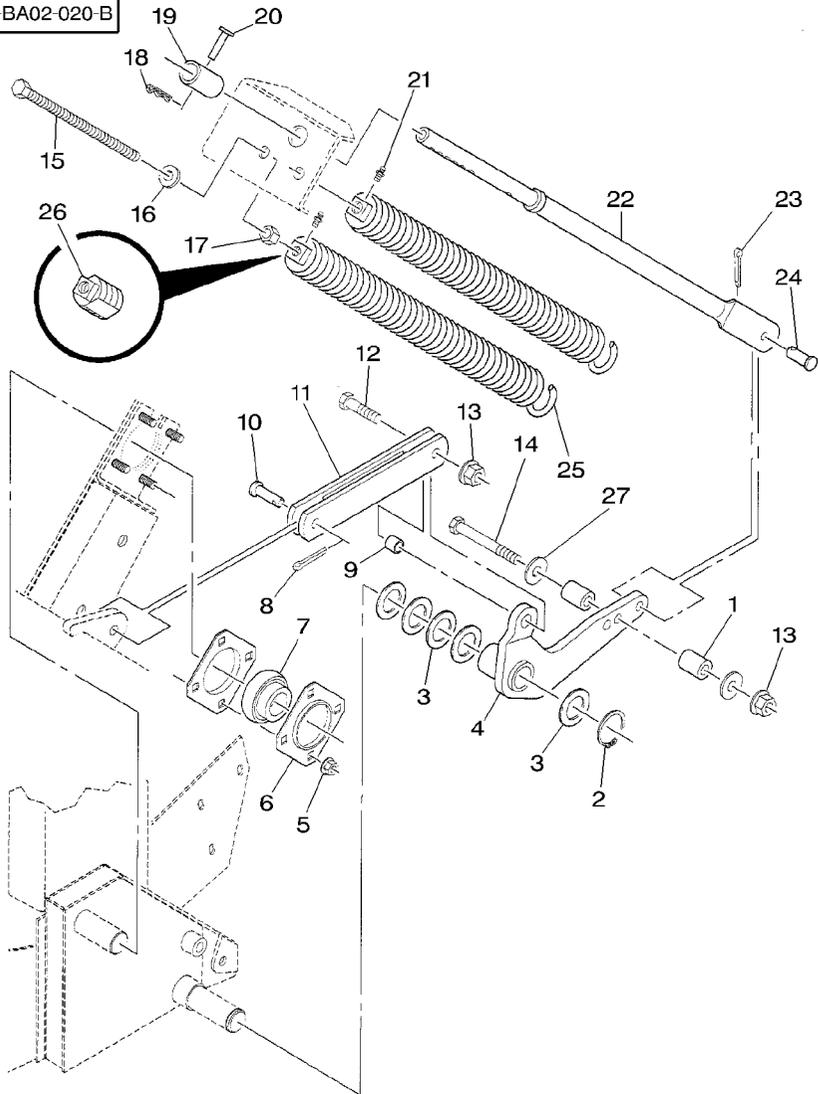

27 700110198

2 PLATE

PLAQUE
PIASTRA

PLATTE
PLATO

Wheel
Roues
Rader
Ruota
Rueda

20-60

Front
Avant
Vorne
Anteriore
Delantero

5-BA28-004-C

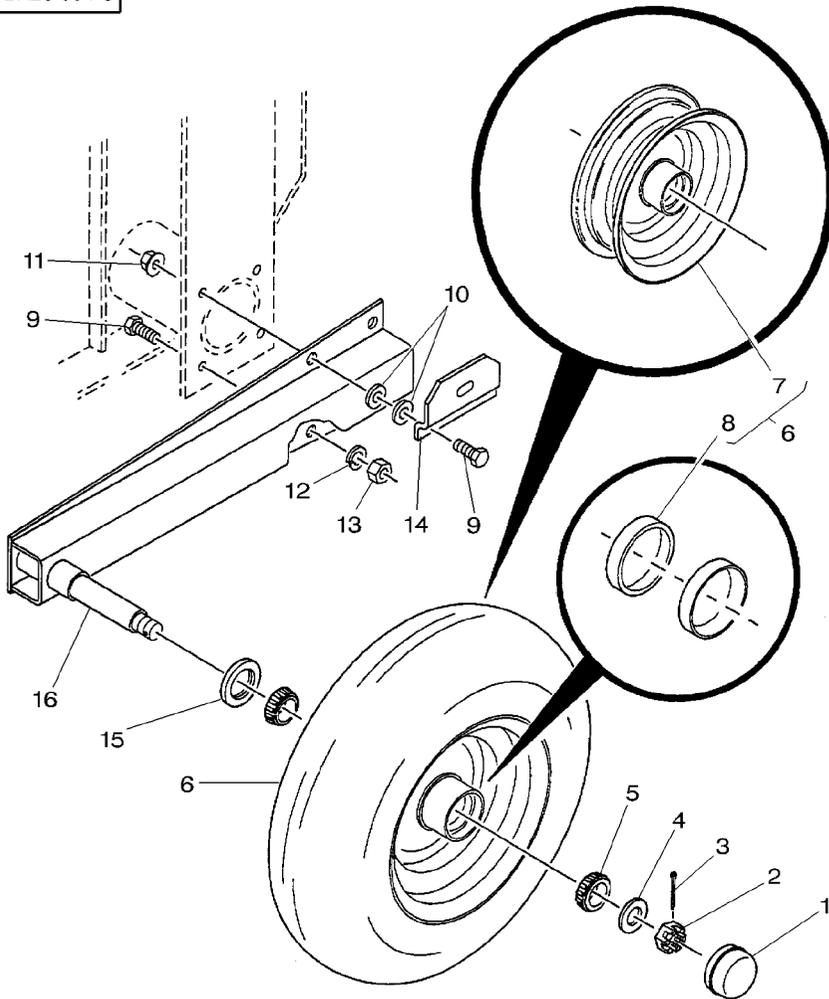

1	26260		2	CAP	CHAPEAU	KAPPE
2	★70918787	3/4"-16	2	NUT	CAPUCHON	TAPA
3	★70918454	1/8" X 1-1/2	2	PIN	ECROU	MUTTER
4	Y705566	3/4"	2	WASHER	DADO	TUERCA
5	70341230		2	WASHER	GOUPILLE	BOLZEN
6	700722670		4	BEARING CONE	PERNO	PASADOR
7	700708048	6	2	WHEEL	RONDELLE	UNTERLEGSCHIEBE
8	832190M1	6	2	WHEEL	RONDELLE	ARANDELA
9	★70921176	1/2"-13 X 1-1/4	4	BEARING CUP	CONE ROULEMENT	LAGERINNENRING
10	705541	1/2"	4	BEARING CUP	CONO CUSCINETTO	CONO COJINETE
11	Y704742	1/2"-13	2	WHEEL	ROUE	RAD
12	705541	1/2"	2	WHEEL	RUOTA	RUEDA
13	Y704742	1/2"-13	2	WHEEL	ROUE	RAD
14	700133681P		2	WHEEL	RUOTA	RUEDA
15	70248372		4	BEARING CUP	CUVETTE ROULEMNT	LAGERAUSSENRING
16	700114064P		4	CAPSCREW	COPPA CUSCINETTO	ANILLO COJINETE
			4	CAPSCREW	VIS BOUCHON	HUTSCHRAUBE
			8	WASHER	TAPPO A VITE	TORNILLO TAPON
			4	LOCKNUT	RONDELLE	UNTERLEGSCHIEBE
			4	WASHER	RONDELLE	ARANDELA
			4	LOCKNUT	ECROU BLOCAGE	SICHERUNGSMUTTER
			4	WASHER	AUTOBLOCCANTE	CONTRATUERCA
			4	LOCKNUT	RONDELLE	UNTERLEGSCHIEBE
			4	LOCKNUT	RONDELLE	ARANDELA
			2	SUPPORT	ECROU BLOCAGE	SICHERUNGSMUTTER
			2	OIL SEAL	AUTOBLOCCANTE	CONTRATUERCA
			2	STRUT	SUPPORT	LAGERUNG
					SUPPORTO	DISPOS.DE SOSTEN
					BAGUE ETANCHEITE	OELDICHTRING
					BOCCOLA PARAOLIO	BUJE RETENACEITE
					JAMBE DE FORCE	VERSTREBUNG
					PUNTONE	CODAL

--	--	--

30

Electrical
Electricite
Elektrizitat
Elettricità
Electricidad

30-5

Main Harness - Up To H.K 91220
Faisceau Principal - Jusqu' Au H.K 91220
Hauptkabelbaum - Bis H.K 91220
Cavo Principale - Fino Alla H.K 91220
Mazo Cables Principale - Hasta H.K 91220

5-BA10-005-E

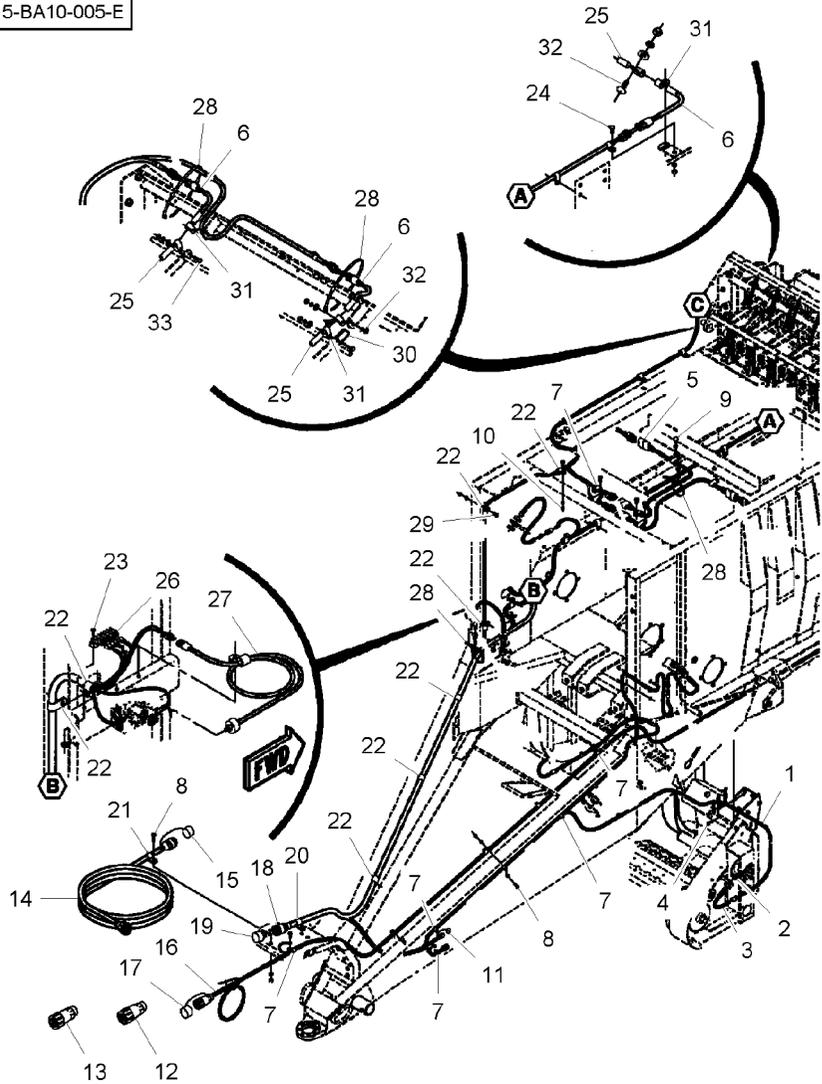

1★70926917	3/8"	37 CLAMP	COLLIER	HALTESCHELLE
2★353436X1	3/4"-16	8 NUT UNF	FASCETTA	ABRAZADERA
3★700706398		4 SENSOR	ECROU UNF	MUTTER UNF
4★7700461	5/16"-18 X 3/4	2 BOLT	DADO UNF	TUERCA UNF
4★70917356	5/16"	2 LOCK WASHER	DETECTEUR	EMPFANGER
4★Y704015	5/16"-18	2 NUT	SENSEUR	DETECTOR
5★700706412		2 CABLE	BOULON	MASCH.SCHRAUBE
6★700113863		3 SWITCH	BULLONE	ESPIGA/BULON
7★70925617	1/2"	9 CLAMP	RONDELLE FREIN	FEDERRING
8★70921210	3/8"-16 X 1	14 CAPSCREW	ROSETTA DENTELL.	ARANDELA GROWER
8★70916965	3/8"	14 LOCK WASHER	ECROU	MUTTER
8★70916950	3/8"-16	14 NUT	DADO	TUERCA
9★70922784	3/8"-16 X 3/4	2 BOLT	DADO	MASCH.SCHRAUBE
9★70916965	3/8"	2 LOCK WASHER	BOULON	ESPIGA/BULON
9★70916950	3/8"-16	2 NUT	BULLONE	FEDERRING
10★70916965	3/8"	4 LOCK WASHER	RONDELLE FREIN	ARANDELA GROWER
10★70916950	3/8"-16	4 NUT	ROSETTA DENTELL.	MUTTER
11★700707016		1 CAP	ECROU	TUERCA
12★700706646	[B]	1 PLUG 7 PIN SUP	DADO	TUERCA
13★1427996M1	[A]	1 PLUG 7 PIN SUP	RONDELLE FREIN	FEDERRING
14★700706459		1 HARNESS	ROSETTA DENTELL.	ARANDELA GROWER
15★700712983	14	1 CAP	ECROU	MUTTER
16★3901303M91	➡ 190LB-50100	1 HARNESS	DADO	TUERCA
16★700706642	➡ 190LB-50101	1 HARNESS	RONDELLE FREIN	FEDERRING
17★Y745216	16	1 CAP	ROSETTA DENTELL.	ARANDELA GROWER
18★700712846		1 HARNESS	ECROU	MUTTER
			DADO	TUERCA
			CHAPEAU	KAPPE
			CAPUCHON	TAPA
			PRISE MALE 7 BR	STECKER 7P ENTST
			SPINA DA 7	TOMA 7 ESPIG SUP
			PRISE MALE 7 BR	STECKER 7P ENTST
			SPINA DA 7	TOMA 7 ESPIG SUP
			FAISCEAU	KABELBAUM
			FASCIOCABI	MAZO CABLES
			CHAPEAU	KAPPE
			CAPUCHON	TAPA
			FAISCEAU	KABELBAUM
			FASCIOCABI	MAZO CABLES
			FAISCEAU	KABELBAUM
			FASCIOCABI	MAZO CABLES
			CHAPEAU	KAPPE
			CAPUCHON	TAPA
			FAISCEAU	KABELBAUM
			FASCIOCABI	MAZO CABLES

Electrical
Electricite
Elektrizitat
Elettricità
Electricidad

30-5

Main Harness - Up To H.K 91220
Faisceau Principal - Jusqu' Au H.K 91220
Hauptkabelbaum - Bis H.K 91220
Cavo Principale - Fino Alla H.K 91220
Mazo Cables Principale - Hasta H.K 91220

5-BA10-005-E

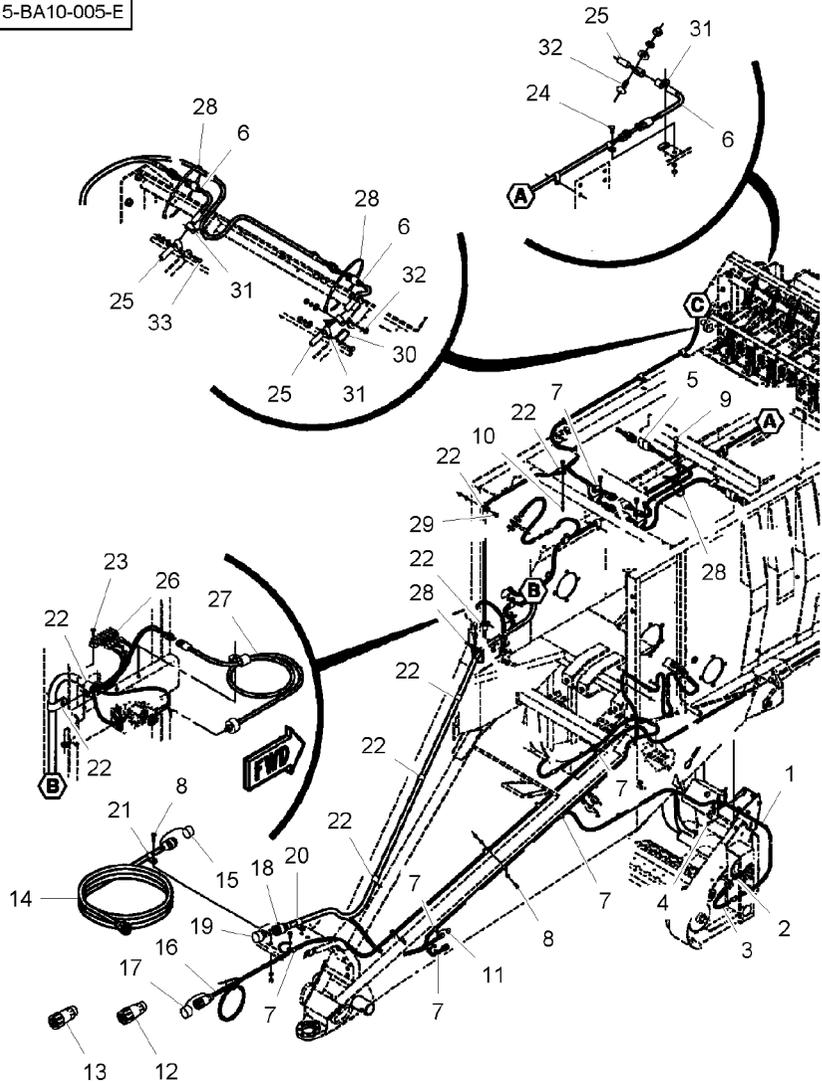

19★700713300	18	1 PLUG	BOUCHON	VERSCHL.STOPFEN
20★360030X1	1"-1/4	1 CLIP	TAPPO	TAPON
21★70925619	5/8"	1 CLAMP	CLIP	SCHELLE
22★70926049	3/4"	8 CLAMP	FERMAGLIO	CLIP
23★700710188	No 6-32 X 3/4	2 SCREW	COLLIER	HALTESCHELLE
23★705129	No 6	2 LOCK WASHER	FASCETTA	ABRAZADERA
23★704551	No 6-32	2 NUT	COLLIER	HALTESCHELLE
24★70921332	5/16"-18 X 3/4	1 CAPSCREW	FASCETTA	ABRAZADERA
24★70917356	5/16"	1 LOCK WASHER	VIS	SCHRAUBE
24★Y704015	5/16"-18	1 NUT	VITE	TORNILLO
25★700706340		3 MAGNET	RONDELLE FREIN	FEDERRING
26★700706645		1 TERMINAL	ROSETTA DENTELL.	ARANDELA GROWER
27★700720228		1 TRANSDUCER	ECROU	MUTTER
28★70925094		4 TIE	DADO	TUERCA
29★70921965	3/8"-16 X 3/4	20 CAPSCREW	VIS BOUCHON	HUTSCHRAUBE
29★70916965	3/8"	20 LOCK WASHER	TAPPO A VITE	TORNILLO TAPON
29★70916950	3/8"-16	20 NUT	RONDELLE FREIN	FEDERRING
30★700138074		1 ANGLE.	ROSETTA DENTELL.	ARANDELA GROWER
31★70926919	1/4"	6 CLAMP	ECROU	MUTTER
32★70931317	1/4"-20 X 3/4	4 BOLT	DADO	TUERCA
32★353769X1	1/4"	4 WASHER	EQUERRE	WINKEL
32★705012	1/4"	4 LOCK WASHER	ANGOLO	ANGULO
32★70916622	1/4"-20	4 NUT	COLLIER	HALTESCHELLE
33★70927401	1/4"-20 X 1	2 CAPSCREW	FASCETTA	ABRAZADERA
33★353769X1	1/4"	2 WASHER	BOULON	MASCH.SCHRAUBE
33★705012	1/4"	2 LOCK WASHER	BULLONE	ESPIGA/BULON
			RONDELLE	UNTERLEGSCHIBE
			RONDELLA	ARANDELA
			RONDELLE FREIN	FEDERRING
			ROSETTA DENTELL.	ARANDELA GROWER
			ECROU	MUTTER
			DADO	TUERCA
			VIS BOUCHON	HUTSCHRAUBE
			TAPPO A VITE	TORNILLO TAPON
			RONDELLE	UNTERLEGSCHIBE
			RONDELLA	ARANDELA
			RONDELLE FREIN	FEDERRING
			ROSETTA DENTELL.	ARANDELA GROWER

Electrical
 Electricite
 Elektrizitat
 Elettricita
 Electricidad

30-5

Main Harness - Up To H.K 91220
 Faisceau Principal - Jusqu'au H.K 91220
 Hauptkabelbaum - Bis H.K 91220
 Cavo Principale - Fino Alla H.K 91220
 Mazo Cables Principale - Hasta H.K 91220

5-BA10-005-E

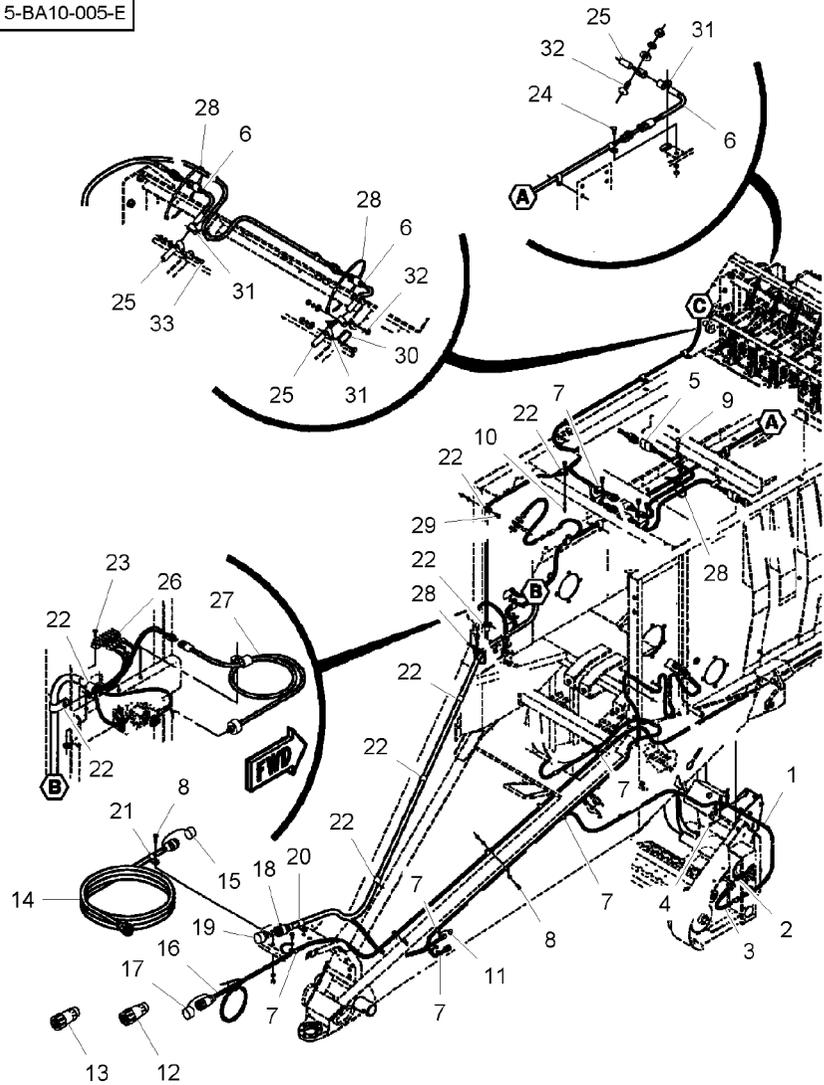

33 70916622

1/4"-20

2 NUT

ECROU
 DADO

MUTTER
 TUERCA

[A] EUROPE ONLY
 EUROPE SEULEMENT
 NUR FUER EUROPA
 SOLO EUROPA
 EUROPA SOLAMENTE

[B] NORTH AMERICA ONLY
 AMERIQUE DU NORD SEULEMENT
 NUR FUER NORDAMERIKA
 NOLO PER IL MERCATO N.A.
 NORTE AMERICA SOLAMENTE

Electrical
Electricite
Elektrizitat
Elettricità
Electricidad

30-10

Main Harness - From H.K 91221
Faisceau Principal - A Partir Du H.K 91221
Hauptkabelbaum - Ab H.K 91221
Cavo Principale - Dalla H.K 91221
Mazo Cables Principale - A Partir Del H.K 91221

5-BA10-010-B

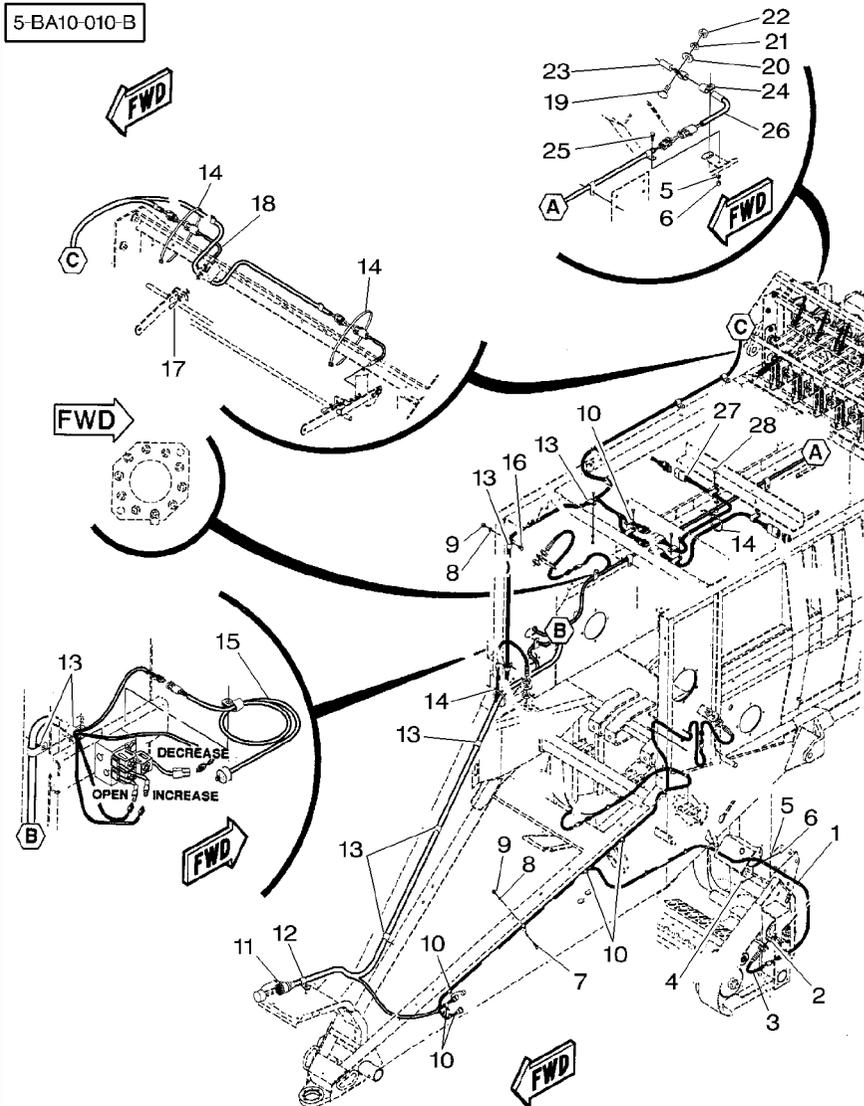

1	70926917	3/8"	28	CLAMP	COLLIER	HALTESCHELLE
2	353436X1	3/4"-16	8	NUT UNF	FASCETTA	ABRAZADERA
3	700706398				ECROU UNF	MUTTER UNF
4	★7700461	5/16"-18 X 3/4	4	SENSOR	DADO UNF	TUERCA UNF
5	★70917356	5/16"	2	BOLT	DETECTEUR	EMPFANGER
6	Y704015	5/16"-18			SENSEUR	DETECTOR
7	★70921210	3/8"-16 X 1	3	LOCK WASHER	BOULON	MASCH.SCHRAUBE
8	★70916965	3/8"			BULLONE	ESPIGA/BULON
9	★70916950	3/8"-16	3	NUT	RONDELLE FREIN	FEDERRING
10	70925617	1/2"			ROSETTA DENTELL.	ARANDELA GROWER
11	700719636		3	CLAMP	ECROU	MUTTER
12	360030X1	1"-1/4			DADO	TUERCA
13	70926049	3/4"	13	CAPSCREW	VIS BOUCHON	HUTSCHRAUBE
14	70925094		39	LOCK WASHER	TAPPO A VITE	TORNILLO TAPON
15	700720228				RONDELLE FREIN	FEDERRING
16	★70921965	3/8"-16 X 3/4	39	NUT	ROSETTA DENTELL.	ARANDELA GROWER
17	700710211				ECROU	MUTTER
18	700119161		7	CLAMP	DADO	TUERCA
19	★70931317	1/4"-20 X 3/4			COLLIER	HALTESCHELLE
20	353769X1	1/4"	1	HARNESS	FASCETTA	ABRAZADERA
21	★705012	1/4"	1	CLIP	FAISCEAU	KABELBAUM
22	★70916622	1/4"-20	1	CLIP	FASCIOCAVI	MAZO CABLES
23	700706340				CLIP	SCHELLE
24	70926919	1/4"	8	CLAMP	FERMAGLIO	CLIP
25	★70921332	5/16"-18 X 3/4			COLLIER	HALTESCHELLE
26	700113863		4	TIE	FASCETTA	ABRAZADERA
			1	TRANSDUCER	ATTACHE	KUPPL.STANGE
			1	TRANSDUCER	TRAVERSA ATTACCO	BARRA DE ENLACE
			20	CAPSCREW	CAPTEUR	NABENTRIEB.
			2	ACTUATOR	TRANSDUCER	TRANSDUCER
			2	SWITCH	VIS BOUCHON	HUTSCHRAUBE
			2	BOLT	TAPPO A VITE	TORNILLO TAPON
			2	WASHER	DECLENCHEUR	BETAETIGUNG
			2	LOCK WASHER	AZIONATORE	ACCIONAMENTO
			2	NUT	INTERRUPTEUR	SCHALTER
			1	MAGNET	INTERRUPTORE	INTERRUPTOR
			2	CLAMP	BOULON	MASCH.SCHRAUBE
			1	CAPSCREW	BULLONE	ESPIGA/BULON
			1	SWITCH	RONDELLE	UNTERLEGSSCHEIBE
					RONDELLA	ARANDELA
					RONDELLE FREIN	FEDERRING
					ROSETTA DENTELL.	ARANDELA GROWER
					ECROU	MUTTER
					DADO	TUERCA
					AIMANT	MAGNET
					MAGNETE	IMAN
					COLLIER	HALTESCHELLE
					FASCETTA	ABRAZADERA
					VIS BOUCHON	HUTSCHRAUBE
					TAPPO A VITE	TORNILLO TAPON
					INTERRUPTEUR	SCHALTER
					INTERRUPTORE	INTERRUPTOR

Electrical
 Electricite
 Elektrizitat
 Elettricita
 Electricidad

30-10

Main Harness - From H.K 91221
 Faisceau Principal - A Partir Du H.K 91221
 Hauptkabelbaum - Ab H.K 91221
 Cavo Principale - Dalla H.K 91221
 Mazo Cables Principale - A Partir Del H.K 91221

5-BA10-010-B

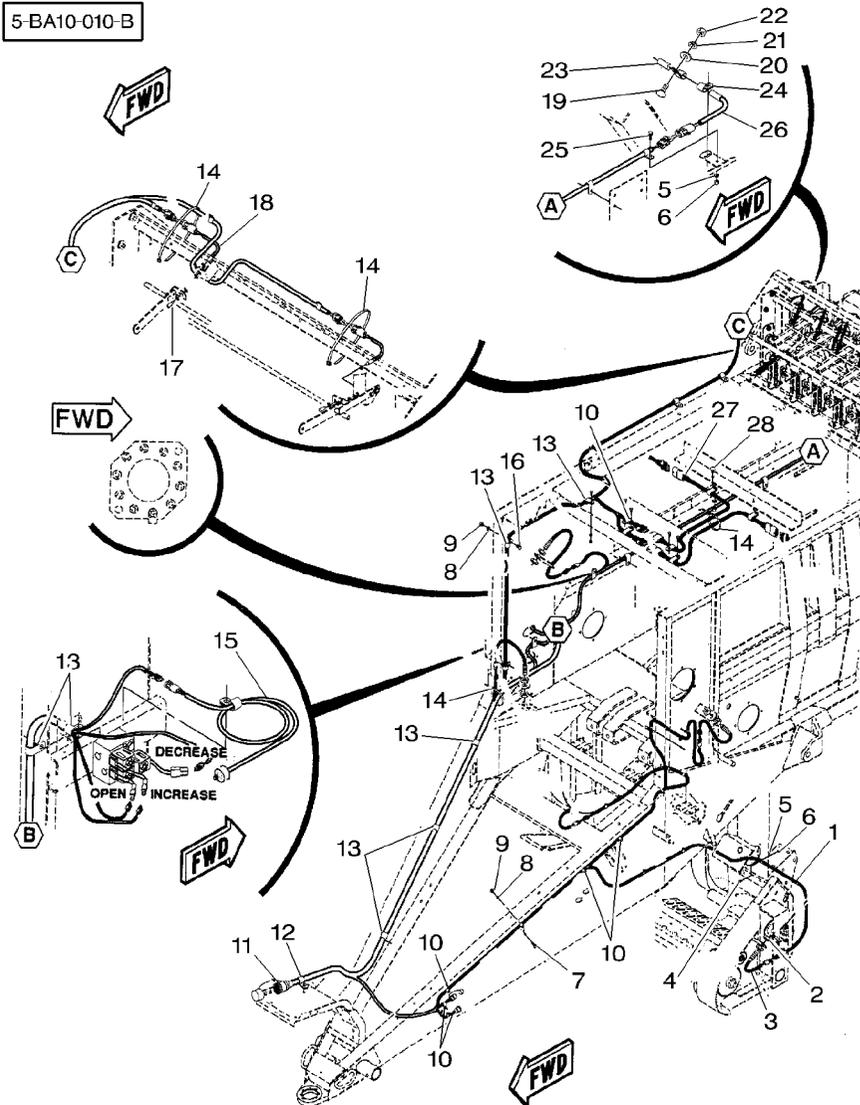

27 700706412

2 CABLE

CABLE

KABEL

28 70922784

3/8"-16 X 3/4

2 BOLT

CAVO
 BOULON
 BULLONE

CABLE
 MASCH.SCHRAUBE
 ESPIGA/BULON

Electrical
Electricite
Elektrizitat
Elettricita
Electricidad

30-15

With Electronic Control
Avec Controle Electronique
Mit Elektronische Steuerung
Con Controllo Elettronico
Con Control Electronico

5-BA10-028-A

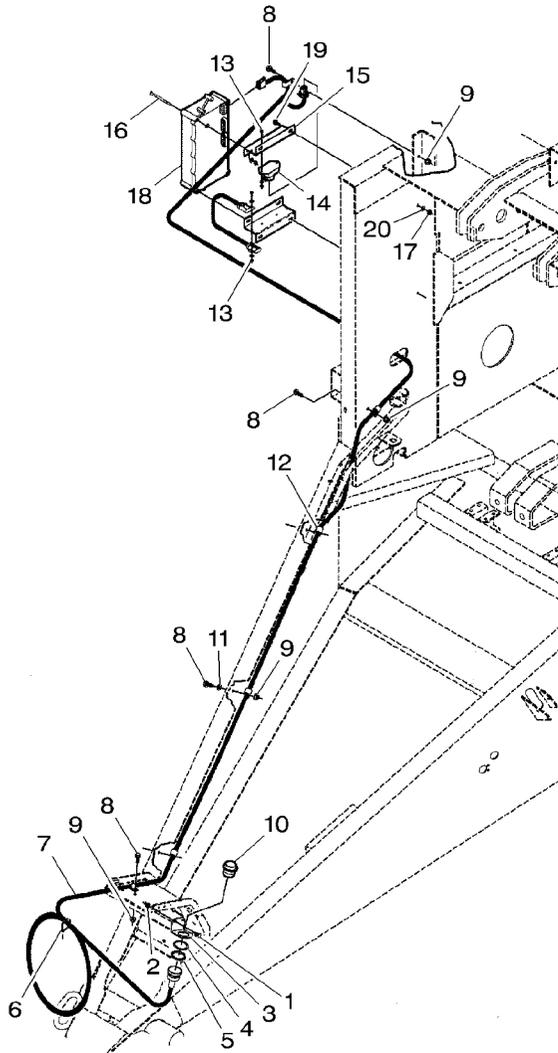

1	★70931317	1/4"-20 X 3/4	2 BOLT	BOULON	MASCH.SCHRAUBE
2	Y704395	1/4"-20	2 NUT	BULLONE	ESPIGA/BULON
3	700154434		1 SUPPORT	ECROU	MUTTER
4	700720550		1 LOCK WASHER	DADO	TUERCA
5	700716842		1 NUT	SUPPORT	LAGERUNG
6	70925094		1 TIE	SUPPORTO	DISPOS.DE SOSTEN
7	700725816		1 HARNESS	RONDELLE FREIN	FEDERRING
8	7883382	3/8"-16 X 1	6 SCREW	ROSETTA DENTELL.	ARANDELA GROWER
9	700711238	3/8"-16	6 LOCKNUT	ECROU	MUTTER
10	700725925		1 CAP	DADO	TUERCA
11	Y705533	3/8"	3 WASHER	ATTACHE	KUPPL.STANGE
12	70925619	5/8"	6 CLAMP	TRAVERSA ATTACCO	BARRA DE ENLACE
13	7701782	No 10-24 X 3/4	3 CAPSCREW	FAISCEAU	KABELBAUM
13	70917380	No 10	4 WASHER	FASCIOCAVI	MAZO CABLES
13	★70926673	No 10-24	3 NUT	VIS	SCHRAUBE
14	700725818		1 MODULE	VITE	TORNILLO
15	700155835		2 SUPPORT	ECROU BLOCAGE	SICHERUNGSMUTTER
16	70931645	1/4"-20 X 3-3/4	4 CAPSCREW	AUTOBLOCCANTE	CONTRATUERCA
16	353769X1	1/4"	8 WASHER	CHAPEAU	KAPPE
16	Y704395	1/4"-20	4 NUT	CAPUCHON	TAPA
17	70931277	5/16"-18	4 NUT	RONDELLE	UNTERLEGSCHIEBE
18	★700724950		1 CONTROL	RONDELLE	ARANDELA
19	7883325	5/16"-18 X 3/4	4 SCREW	COLLIER	HALTESCHELLE
20	Y705525	5/16"	4 WASHER	FASCETTA	ABRAZADERA
				VIS BOUCHON	HUTSCHRAUBE
				TAPPO A VITE	TORNILLO TAPON
				RONDELLE	UNTERLEGSCHIEBE
				RONDELLE	ARANDELA
				ECROU	MUTTER
				DADO	TUERCA
				ECROU	MUTTER
				DADO	TUERCA
				CONTROLLE	STEUERUNG
				CONTROLLO	MANDO
				VIS	SCHRAUBE
				VITE	TORNILLO
				RONDELLE	UNTERLEGSCHIEBE
				RONDELLA	ARANDELA

Electrical
Electricite
Elektrizitat
Elettricita
Electricidad

30-20

With Electronic Control
Avec Controle Electronique
Mit Elektronische Steuerung
Con Controllo Elettronico
Con Control Electronico

5-BA10-029-A

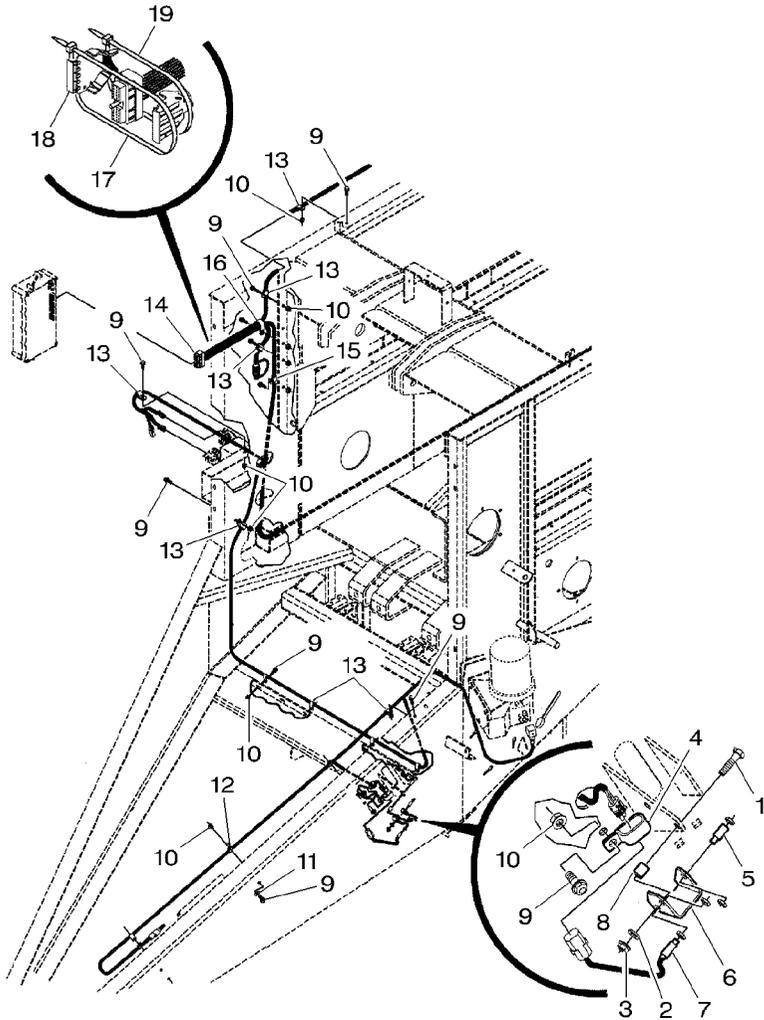

1	70921977	5/16"-18 X 1-1/4	1	CAPSCREW	VIS BOUCHON	HUTSCHRAUBE
2	Y705525	5/16"	1	WASHER	TAPPO A VITE	TORNILLO TAPON
3	70931277	5/16"-18	1	NUT	RONDELLE	UNTERLEGSCHIBE
4	700717627		1	CLAMP	RONDELLA	ARANDELA
5	700710211		1	ACTUATOR	ECROU	MUTTER
6	700155843		1	CHANNEL	DADO	TUERCA
7	700119161		1	SWITCH	COLLIER	HALTESCHELLE
8	6523799		1	BUSH	FASCETTA	ABRAZADERA
9	7883382	3/8"-16 X 1	16	SCREW	DECLENCHEUR	BETAETIGUNG
10	700711238	3/8"-16	1	LOCKNUT	AZIONATORE	ACCIONAMENTO
11	Y705533	3/8"	3	WASHER	CANAL	KANAL
12	70926917	3/8"	4	CLAMP	PROFILATO	CANAL
13	70925617	1/2"	10	CLAMP	INTERRUPTEUR	SCHALTER
14	700725819		1	HARNESS	INTERRUPTORE	INTERRUPTOR
15	70925619	5/8"	1	CLAMP	BAGUE	BUCHSE
16	700725832	1"-1/8	1	CLAMP	BOCCOLA	CASQUILLO
17	3619622M1		1	CABLE TIE	VIS	SCHRAUBE
18	700720952		2	COVER	VITE	TORNILLO
19	70925094		1	TIE	ECROU BLOCAGE	SICHERUNGSMUTTER
					AUTOBLOCCANTE	CONTRATUERCA
					RONDELLE	UNTERLEGSCHIBE
					RONDELLA	ARANDELA
					COLLIER	HALTESCHELLE
					FASCETTA	ABRAZADERA
					COLLIER	HALTESCHELLE
					FASCETTA	ABRAZADERA
					FAISCEAU	KABELBAUM
					FASCIOCAVI	MAZO CABLES
					COLLIER	HALTESCHELLE
					FASCETTA	ABRAZADERA
					COLLIER	HALTESCHELLE
					FASCETTA	ABRAZADERA
					ATTACHE CABLE	KABELBINDER
					FASCETTA CAVI	APRIETACABLES
					COUVERCLE	DECKEL
					COPERCHIO	CUBIERTA
					ATTACHE	KUPPLSTANGE
					TRAVERSA ATTACCO	BARRA DE ENLACE

Electrical
Electricite
Elektrizitat
Elettricita
Electricidad

30-25

With Electronic Control
Avec Controle Electronique
Mit Elektronische Steuerung
Con Controllo Elettronico
Con Control Electronico

5-BA10-030-A

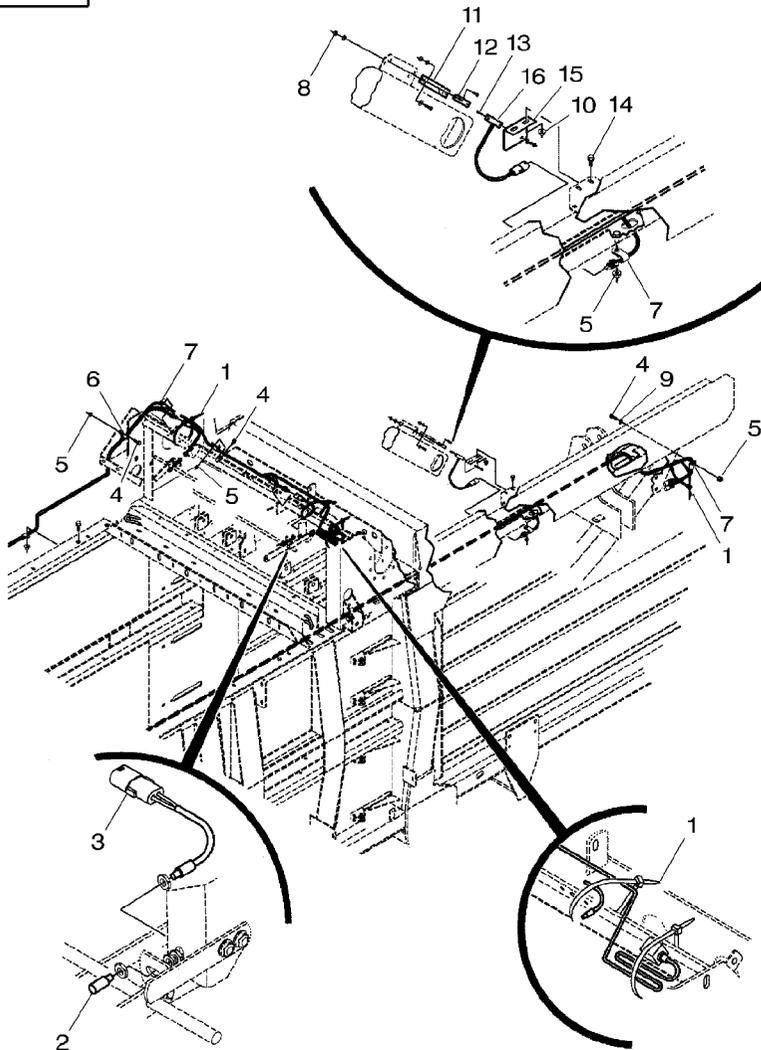

1	70925094		5	TIE	ATTACHE	KUPPL.STANGE
2	700710211		5	TRAVERSA ATTACCO	BARRA DE ENLACE	
3	700119161		2	ACTUATOR	DECLENCHEUR	BETAETIGUNG
4	7883382	3/8"-16 X 1	2	ACTUATOR	AZIONATORE	ACCIONAMIENTO
5	700711238	3/8"-16	1	SWITCH	INTERRUPTEUR	SCHALTER
6	70925617	1/2"	1	SWITCH	INTERRUPTORE	INTERRUPTOR
7	70926917	3/8"	6	SCREW	VIS	SCHRAUBE
8	700711659	No 8-32 X 3/4	7	LOCKNUT	VITE	TORNILLO
8	70923906	No 8	7	LOCKNUT	ECROU BLOCCAGE	SICHERUNGSMUTTER
8	7775414	No 8-32	2	CLAMP	AUTOBLOCCANTE	CONTRATUERCA
9	Y705533	3/8"	2	CLAMP	COLLIER	HALTESCHELLE
10	70931277	5/16"-18	5	CLAMP	FASCETTA	ABRAZADERA
11	700122574		5	CLAMP	COLLIER	HALTESCHELLE
12	700709996		2	SCREW	FASCETTA	ABRAZADERA
13	700710188	No 6-32 X 3/4	2	SCREW	VIS	SCHRAUBE
13	700703830	No 6	4	FLAT WASHERS	VITE	TORNILLO
13	700710189	No 6-32	4	FLAT WASHERS	RONDELLES PLATES	UNTERLEGSCHIEBEN
14	7883325	5/16"-18 X 3/4	2	LOCKNUT	RONDELLE PIANA	ARANDELAS PLANAS
15	700138067		1	WASHER	ECROU BLOCCAGE	SICHERUNGSMUTTER
16	700710208		1	WASHER	AUTOBLOCCANTE	CONTRATUERCA
			1	WASHER	RONDELLE	UNTERLEGSCHIEBE
			2	NUT	RONDELLA	ARANDELA
			1	SUPPORT	ECROU	MUTTER
			1	SUPPORT	DADO	TUERCA
			1	ACTUATOR	SUPPORTO	LAGERUNG
			1	ACTUATOR	DISPOSITIVO	DISPOS.DE SOSTEN
			4	SCREW	DECLENCHEUR	BETAETIGUNG
			4	WASHER	AZIONATORE	ACCIONAMIENTO
			4	NUT	VIS	SCHRAUBE
			2	SCREW	VITE	TORNILLO
			1	ANGLE.	RONDELLE	UNTERLEGSCHIEBE
			1	SWITCH	RONDELLA	ARANDELA
			1	SWITCH	ECROU	MUTTER
			1	SWITCH	DADO	TUERCA
			1	SWITCH	VIS	SCHRAUBE
			1	SWITCH	VITE	TORNILLO
			1	SWITCH	EQUERRE	WINKEL
			1	SWITCH	ANGOLO	ANGULO
			1	SWITCH	INTERRUPTEUR	SCHALTER
			1	SWITCH	INTERRUPTORE	INTERRUPTOR

Electrical
Electricite
Elektrizitat
Elettricità
Electricidad

30-30

With Electronic Control
Avec Controle Electronique
Mit Elektronische Steuerung
Con Controllo Elettronico
Con Control Electronico

5-BA10-031-B

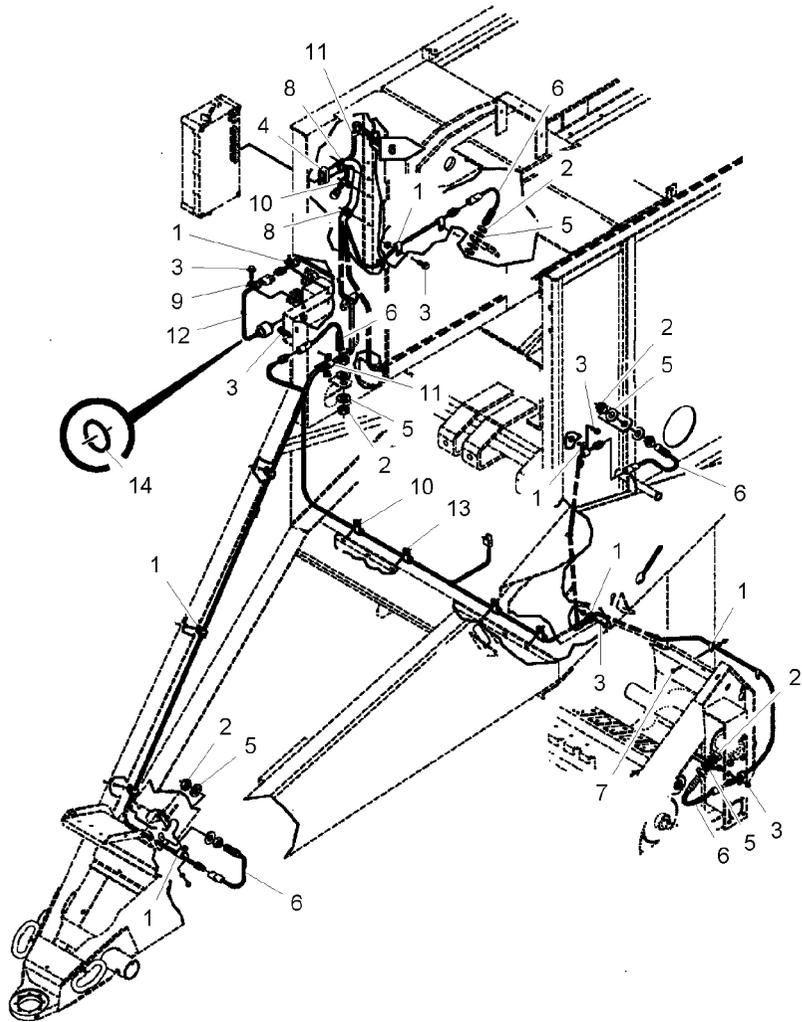

1	70926917	3/8"	12	CLAMP	COLLIER	HALTESCHELLE
2	353436X1	3/4"-16	10	NUT UNF	FASCETTA	ABRAZADERA
3	7883382	3/8"-16 X 1			ECROU UNF	MUTTER UNF
3	700711238	3/8"-16	7	SCREW	DADO UNF	TUERCA UNF
4	700725821				VIS	SCHRAUBE
5	Y705566	3/4"	7	LOCKNUT	VITE	TORNILLO
6	700706398		7	LOCKNUT	ECROU BLOCAGE	SICHERUNGSMUTTER
7	★7700461	5/16"-18 X 3/4	1	HARNESS	AUTOBLOCCANTE	CONTRATUERCA
7	Y705525	5/16"			FAISCEAU	KABELBAUM
7	70931277	5/16"-18	10	WASHER	FASCIOCABI	MAZO CABLES
8	700725832	1"-1/8			RONDELLE	UNTERLEGSCHIEBE
9	70928654	1/4"	5	SENSOR	RONDELLA	ARANDELA
10	70925617	1/2"			DETECTEUR	EMPFANGER
11	70925619	5/8"	2	BOLT	SENSEUR	DETECTOR
12	700722199		2	WASHER	BOULON	MASCH.SCHRAUBE
13	★70926049	3/4"			BULLONE	ESPIGA/BULON
14	★70921882		2	NUT	RONDELLE	UNTERLEGSCHIEBE
			2	CLAMP	RONDELLA	ARANDELA
			1	CLAMP	ECROU	MUTTER
			5	CLAMP	DADO	TUERCA
			2	CLAMP	COLLIER	HALTESCHELLE
			1	TRANSDUCER	FASCETTA	ABRAZADERA
			4	CLAMP	COLLIER	HALTESCHELLE
			1	O RING	FASCETTA	ABRAZADERA
					ABRAZADERA	HALTESCHELLE
					JOINT TORIQUE	ANILLO FORMA 'O'
					ANELLO TENUTA	

Electrical
 Electricite
 Elektrizitat
 Elettricita
 Electricidad

30-35

With Electronic Control
 Avec Controle Electronique
 Mit Elektronische Steuerung
 Con Controllo Elettronico
 Con Control Electronico

5-BA10-032-A

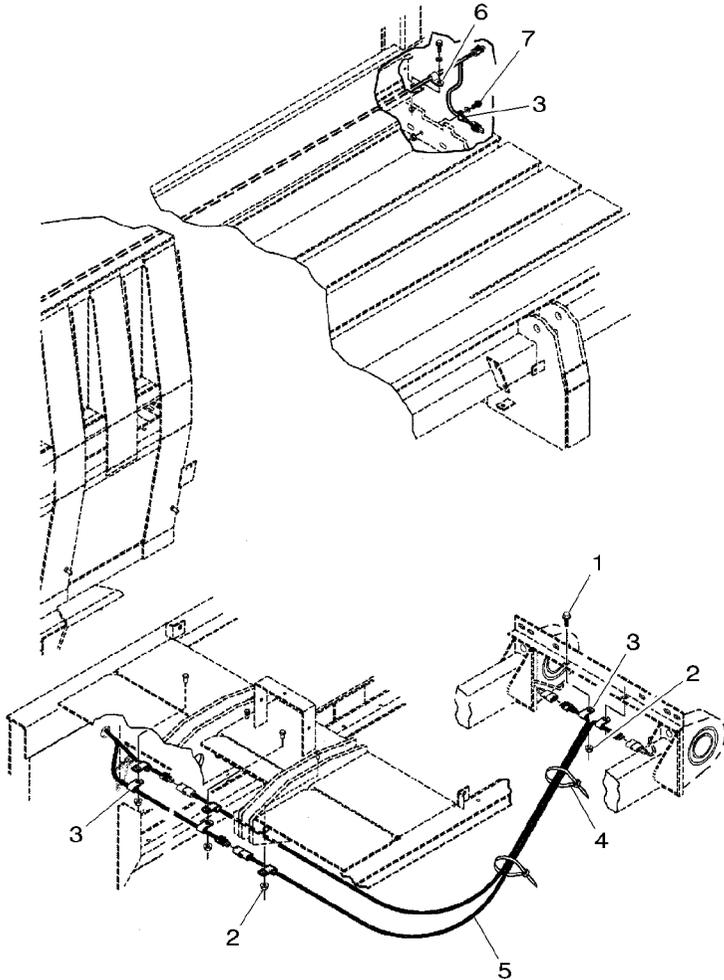

1	7883382	3/8"-16 X 1	2	SCREW	VIS	SCHRAUBE
2	700711238	3/8"-16	5	LOCKNUT	VITE	TORNILLO
3	70926917	3/8"			ECROU BLOCAGE	SICHERUNGSMUTTER
4	70925094		8	CLAMP	AUTOBLOCCANTE	CONTRATUERCA
5	700716724				COLLIER	HALTESCHELLE
6	70925617	1/2"	2	TIE	FASCETTA	ABRAZADERA
7	7883333	5/16"-18 X 1			ATTACHE	KUPPL.STANGE
7	Y705525	5/16"	2	CABLE	TRAVERSA ATTACCO	BARRA DE ENLACE
7	70931277	5/16"-18			CABLE	KABEL
			1	CLAMP	CAVO	CABLE
					COLLIER	HALTESCHELLE
					FASCETTA	ABRAZADERA
			2	SCREW	VIS	SCHRAUBE
					VITE	TORNILLO
			2	WASHER	RONDELLE	UNTERLEGSCHIEBE
					RONDELLA	ARANDELA
					ECROU	MUTTER
			2	NUT	DADO	TUERCA

Lighting Equipment
Eclairage
Beleuchtung
Equipaggiamento Illuminazione
Equipo Alumbrado

30-40

➔ 190LB-50100

5 BA49 004 C

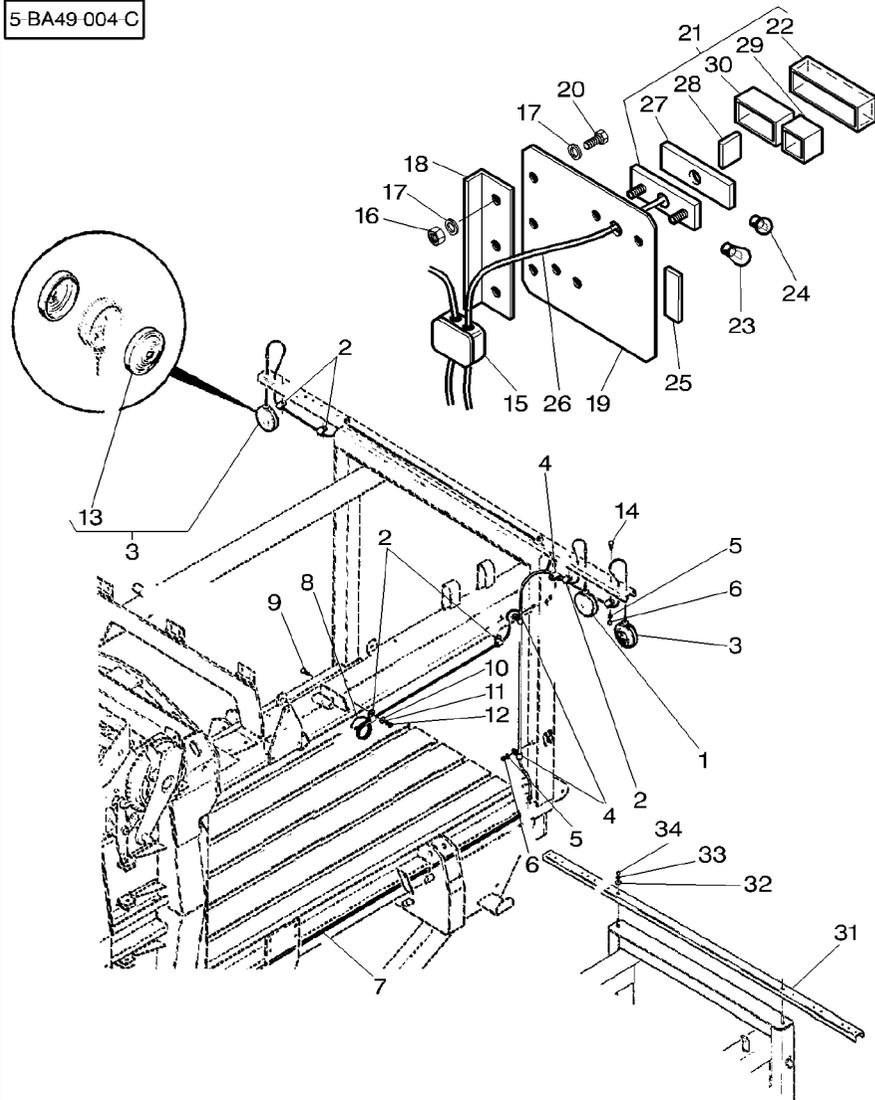

1	700710290		1 LIGHT	FEU	LEUCHTE
2	70928654	1/4"	6 CLAMP	FARO	LAMPARA/LUZ
3	700708036		2 LIGHT	COLLIER	HALTESCHELLE
4	70925617	1/2"	3 CLAMP	FASCETTA	ABRAZADERA
5	353434X1	3/8"	7 LOCK WASHER	FEU	LEUCHTE
6	355566X1	3/8"-16	7 NUT UNC	FARO	LAMPARA/LUZ
7	700706642		1 HARNESS	COLLIER	HALTESCHELLE
8	70925094		1 TIE	FASCETTA	ABRAZADERA
9	364352X1	5/16"-18 X 3/4	7 LOCK WASHER	RODELLE FREIN	FEDERRING
10	Y705525	5/16"	7 NUT UNC	ROSETTA DENTELL.	ARANDELA GROWER
11	353446X1	5/16"	1 HARNESS	ECROU UNC	MUTTER UNC
12	355565X1	5/16"-18	1 TIE	DADO UNC	TUERCA UNC
13	71193862	3	1 HARNESS	FAISCEAU	KABELBAUM
14	353689X1	3/8"-16 X 3/4	1 TIE	FASCIOCAVI	MAZO CABLES
15	3901305M91	[A]	2 BOLT UNC	ATTACHE	KUPPL.STANGE
16	366573X1	[A]	2 BOLT UNC	TRAVERSA ATTACCO	BARRA DE ENLACE
17	353756X1	[A]	2 WASHER	BOULON UNC	MASCH.SCHRB.UNC
18	3901300M1	[AB]	2 LOCK WASHER	BULLONE UNC	PERNO UNC
19	3901299M1	[A]	2 LOCK WASHER	RODELLE	UNTERLEGSCHHEIBE
20	353691X1	[A]	2 NUT UNC	RODELLE	ARANDELA
21	3901301M91	[A]	2 NUT UNC	RODELLE FREIN	FEDERRING
22	3901379M1	21 [A]	2 NUT UNC	ROSETTA DENTELL.	ARANDELA GROWER
23	621235M1	[A]	4 LENS	ECROU UNC	MUTTER UNC
24	1892056M1	[A]	5 BOLT UNC	DADO UNC	TUERCA UNC
25	3901308M1	[A]	4 LENS	LENTILLE	LINSE
26	3901302M91	[A]	1 BOX	LENTE	LENTE DE VIDRIO
			6 LOCKNUT	BOULON UNC	MASCH.SCHRB.UNC
			12 WASHER	BULLONE UNC	PERNO UNC
			2 BRACKET	BOITE	DOSE
			2 PLATE	SCATOLA	CAJA
			6 BOLT UNC	ECROU BLOCAGE	SICHERUNGSMUTTER
			2 LIGHT	AUTOBLOCCANTE	CONTRATUERCA
			1 LENS	RODELLE	UNTERLEGSCHHEIBE
			4 BULB 12V 21W SBC	RODELLE	ARANDELA
			4 BULB 12V 5W	SUPPORT FIXATION	HALTEAM
			2 REFLECTOR	STAFFETTA	SOPORTE
			1 HARNESS	PLAQUE	PLATTE
				PIASTRA	PLATO
				BOULON UNC	MASCH.SCHRB.UNC
				BULLONE UNC	PERNO UNC
				FEU	LEUCHTE
				FARO	LAMPARA/LUZ
				LENTILLE	LINSE
				LENTE	LENTE DE VIDRIO
				AMPOULE 12V 21W	GLUEHL 12V21WSBC
				BULBO 12V 21W	BOMB 12V 21W SBC
				AMPOULE 12V 5W	GLUEHL 12V 5W
				BULBO 12V 5W	BOMBILLA 12V 5W
				CATADIOPTR	REFLEKTOR
				OJO DE GATO	CATADIOPTRICO
				FAISCEAU	KABELBAUM
				FASCIOCAVI	MAZO CABLES

Lighting Equipment
Eclairage
Beleuchtung
Equipaggiamento Illuminazione
Equipo Alumbrado

30-40

➔ 190LB-50100

5 BA49 004 C

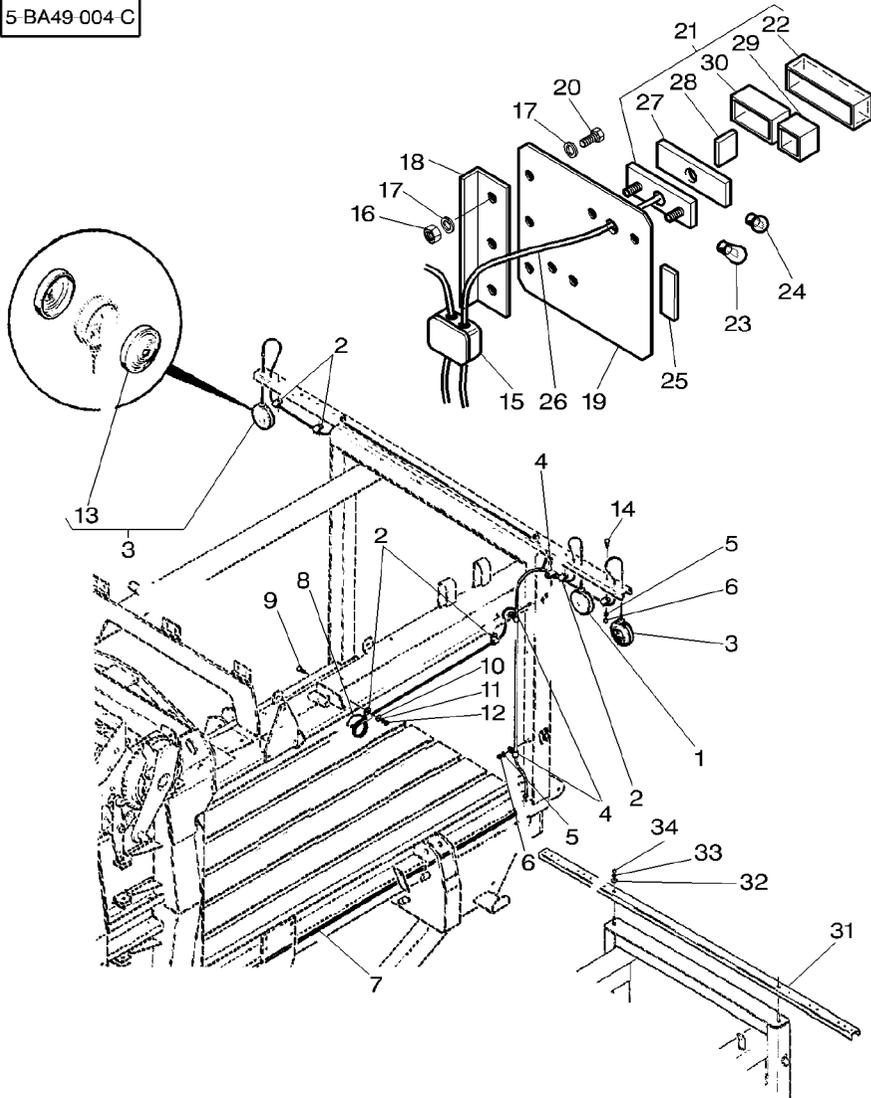

27	3901383M1	21 [A]	1	HOLDER	PIECE SUPPORT	HALTER
28	3901382M1	21 [A]	1	PLATE	SUPPORTO DI BASE	SUJETADOR
29	3901381M1	21 [A]	1	LENS	PLAQUE	PLATTE
		AMBER			PIASTRA	PLATO
30	3901380M1	21 [A]	1	LENS	LENTILLE	LINSE
		RED			LENTE	LENTE DE VIDRIO
31	700114020		1	CHANNEL	LENTILLE	LINSE
					LENTE	LENTE DE VIDRIO
32	Y705533	3/8"	X	WASHER	CANAL	KANAL
					PROFILATO	CANAL
33	353434X1	3/8"	X	LOCK WASHER	RONDELLE	UNTERLEGSCHIEBE
					RONDELLA	ARANDELA
34	355566X1	3/8"-16	X	NUT UNC	RONDELLE FREIN	FEDERRING
					ROSETTA DENTELL.	ARANDELA GROWER
					ECROU UNC	MUTTER UNC
					DADO UNC	TUERCA UNC

[A] EUROPE ONLY
EUROPE SEULEMENT
NUR FUER EUROPA
SOLO EUROPA
EUROPA SOLAMENTE

[B] WELDED
SOUDE
SCHWEISSEN
SALDATE
SOLDURA

Lighting Equipment
Eclairage
Beleuchtung
Equipaggiamento Illuminazione
Equipo Alumbrado

30-45

From 190lb-50101 - Up To H.K 91220
A Partir Du 190lb-50101 - Jusqu' Au H.K 91220
Ab Den 190lb-50101 - Bis H.K 91220
Dalla 190lb-50101 - Fino Alla H.K 91220
A Partir Del 190lb-50101 - Hasta H.K 91220

5-BA49-008-E

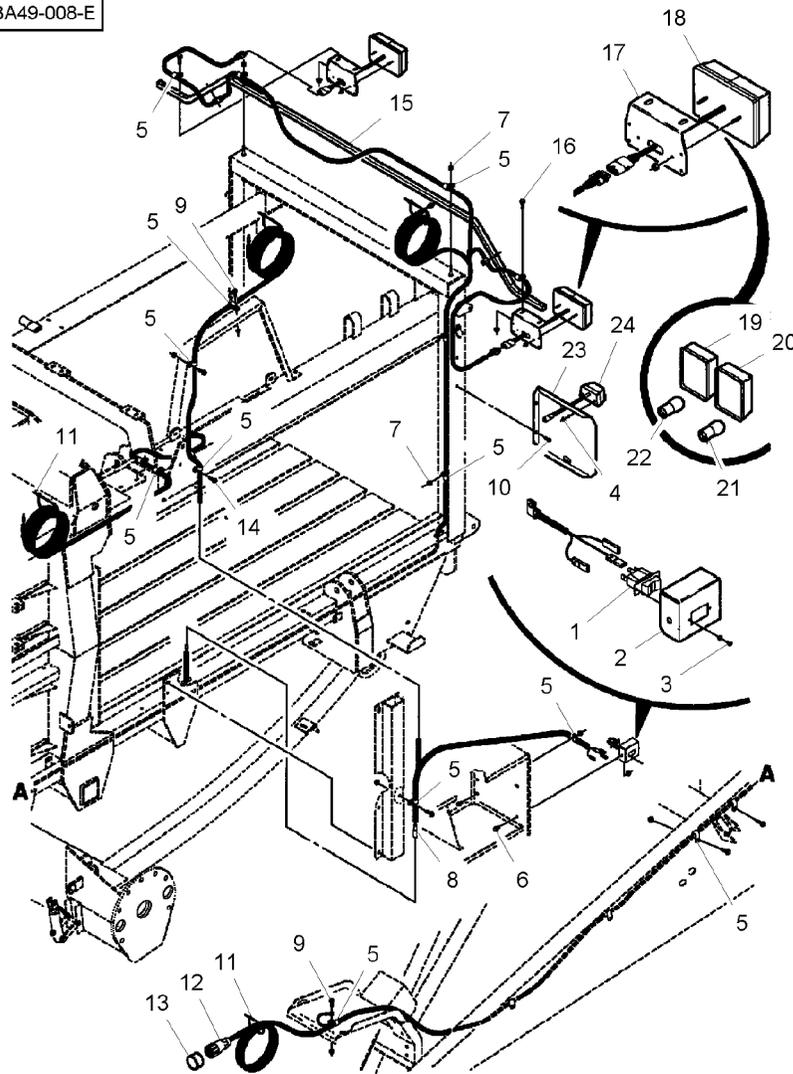

1	★700715143		1 SWITCH	INTERRUPTEUR	SCHALTER
2	★700133171		1 SUPPORT	INTERRUPTORE	INTERRUPTOR
3	★700707619	No 6-32 X 1/2	2 SCREW	SUPPORT	LAGERUNG
3	★705129	No 6	2 LOCK WASHER	SUPPORTO	DISPOS.DE SOSTEN
4	★705004	No 10	2 LOCK WASHER	VITE	SCHRAUBE
4	★7774078	M5	2 NUT	RONDELLE FREIN	FEDERRING
5	★70926917	3/8"	20 CLAMP	ROSETTA DENTELL.	ARANDELA GROWER
6	★7883374	3/8"-16 X 3/4	1 SCREW	ROSETTA DENTELL.	ARANDELA GROWER
6	★Y704734	3/8"-16	1 LOCKNUT	ECROU	MUTTER
7	★Y704734	3/8"-16	4 LOCKNUT	DADO	TUERCA
8	★700715694		1 HARNESS	COLLIER	HALTESCHELLE
9	★7883333	5/16"-18 X 1	2 SCREW	FASCETTA	ABRAZADERA
9	★Y704726	5/16"-18	2 LOCKNUT	VIS	SCHRAUBE
10	★7883325	5/16"-18 X 3/4	2 SCREW	VITE	TORNILLO
11	★70937133		3 TIE	ECROU BLOCAGE	SICHERUNGSMUTTER
12	★700715514		1 HARNESS	AUTOBLOCCANTE	CONTRATUERCA
13	★Y745216		1 CAP	ECROU BLOCAGE	SICHERUNGSMUTTER
14	★7883382	3/8"-16 X 1	1 SCREW	AUTOBLOCCANTE	CONTRATUERCA
14	★Y704734	3/8"-16	1 LOCKNUT	ECROU BLOCAGE	SICHERUNGSMUTTER
15	★700133723		1 SUPPORT	AUTOBLOCCANTE	CONTRATUERCA
16	★70921971	3/8"-16 X 1-3/4	6 CAPSCREW	SUPPORTO	LAGERUNG
16	★Y704734	3/8"-16	6 LOCKNUT	SUPPORTO	DISPOS.DE SOSTEN
17	★700133748		2 PLATE	VIS BOUCHON	HUTSCHRAUBE
18	★700714721	➡ 190LB-50146	2 LIGHT	TAPPO A VITE	TORNILLO TAPON
18	★700716461	➡ 190LB-50147	2 LIGHT	ECROU BLOCAGE	SICHERUNGSMUTTER
19	★700717386	18 [A]	1 LENS	AUTOBLOCCANTE	CONTRATUERCA
				PLAQUE	PLATTE
				PIASTRA	PLATO
				FEU	LEUCHTE
				FARO	LAMPARA/LUZ
				FEU	LEUCHTE
				FARO	LAMPARA/LUZ
				LENTILLE	LINSE
				LENTE	LENTE DE VIDRIO

Lighting Equipment
Eclairage
Beleuchtung
Equipaggiamento Illuminazione
Equipo Alumbrado

30-45

From 190lb-50101 - Up To H.K 91220
A Partir Du 190lb-50101 - Jusqu' Au H.K 91220
Ab Den 190lb-50101 - Bis H.K 91220
Dalla 190lb-50101 - Fino Alla H.K 91220
A Partir Del 190lb-50101 - Hasta H.K 91220

5-BA49-008-E

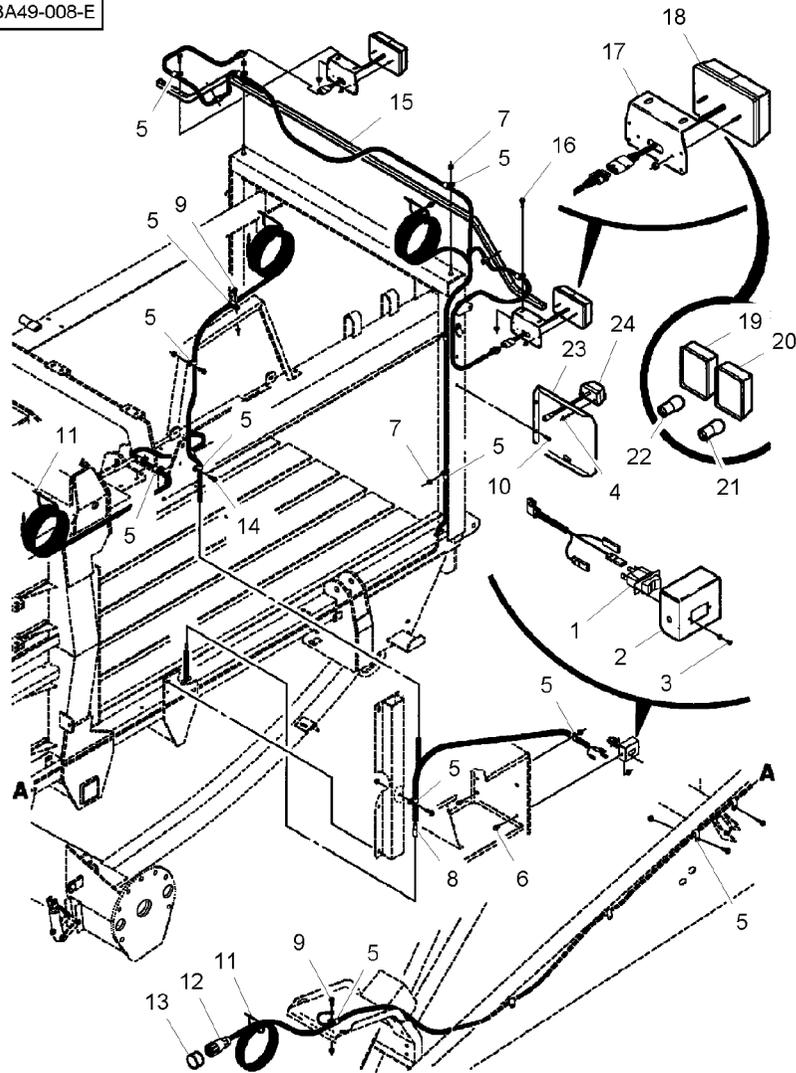

20★700717417	18 [B]	1 LENS	LENTILLE	LINSE
21★908543M1	18	1 BULB S/L 21/5W	LENTILLES	LENTE DE VIDRIO
22★621235M1	18	1 BULB 12V 21W SBC	AMPOULE 21/5W	GLUEHLAMPE 21/5W
23★700133747		1 SUPPORT	BULBO 21/5W	BOMB C/I 21/5W
24★700716772		1 LIGHT	AMPOULE 12V 21W	GLUEHL 12V21WSBC
			BULBO 12V 21W	BOMB 12V 21W SBC
			SUPPORT	LAGERUNG
			SUPPORTO	DISPOS.DE SOSTEN
			FEU	LEUCHTE
			FARO	LAMPARA/LUZ

[A] RED
ROUGE
ROT
ROSSO
ROJO

[B] ORANGE
ORANGE
ORANGE
ARANCIONE
ANARANJADO

Lighting Equipment
Eclairage
Beleuchtung
Equipaggiamento Illuminazione
Equipo Alumbrado

30-50

From H.K 91221 - Up To H.P 91215
A Partir Du H.K 91221 - Jusqu' Au H.P 91215
Ab H.K 91221 - Bis H.P 91215
Dalla H.K 91221 - Fino Alla H.P 91215
A Partir Del H.K 91221 - Hasta H.P 91215

5-BA49-016-B

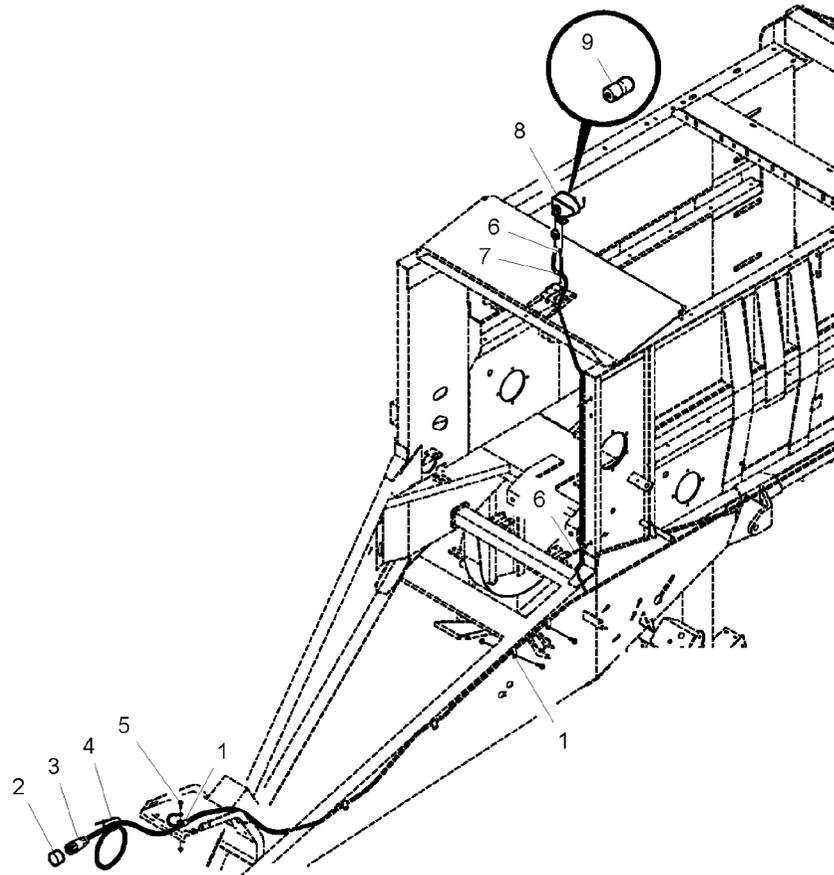

1	★70925619	5/8"	5	CLAMP	COLLIER	HALTESCHELLE
2	★Y745216		1	CAP	FASCETTA	ABRAZADERA
3	★700726142	➡ HN 91426	1	HARNESS	CHAPEAU	KAPPE
3	★700722922	➡ HN 91427	1	HARNESS	CAPUCHON	TAPA
4	★70925094		1	TIE	FAISCEAU	KABELBAUM
5	★7883325	5/16"-18 X 3/4	1	SCREW	FASCIOCAVI	MAZO CABLES
5	★Y704726	5/16"-18	1	LOCKNUT	FAISCEAU	KABELBAUM
6	★7883382	3/8"-16 X 1	2	SCREW	FASCIOCAVI	MAZO CABLES
6	★Y704734	3/8"-16	2	LOCKNUT	ATTACHE	KUPPL.STANGE
7	★70926917	3/8"	3	CLAMP	TRAVERSA ATTACCO	BARRA DE ENLACE
8	★700726172		1	LIGHT	VIS	SCHRAUBE
9	★700722351	8	1	BULB	VITE	TORNILLO
					ECROU BLOCAGE	SICHERUNGSMUTTER
					AUTOBLOCCANTE	CONTRATUERCA
					VIS	SCHRAUBE
					VITE	TORNILLO
					ECROU BLOCAGE	SICHERUNGSMUTTER
					AUTOBLOCCANTE	CONTRATUERCA
					COLLIER	HALTESCHELLE
					FASCETTA	ABRAZADERA
					FEU	LEUCHE
					FARO	LAMPARA/LUZ
					AMPOULE	GLUEHLAMPE
					BULBO	BOMBILLA

Lighting Equipment
Eclairage
Beleuchtung
Equipaggiamento Illuminazione
Equipo Alumbrado

30-55

From H.K 91221 - Up To H.P 91215
A Partir Du H.K 91221 -Jusqu' Au H.P 91215
Ab H.K 91221 - Bis H.P 91215
Dalla H.K 91221 - Fino Alla H.P 91215
A Partir Del H.K 91221 - Hasta H.P 91215

5-BA49-024-A

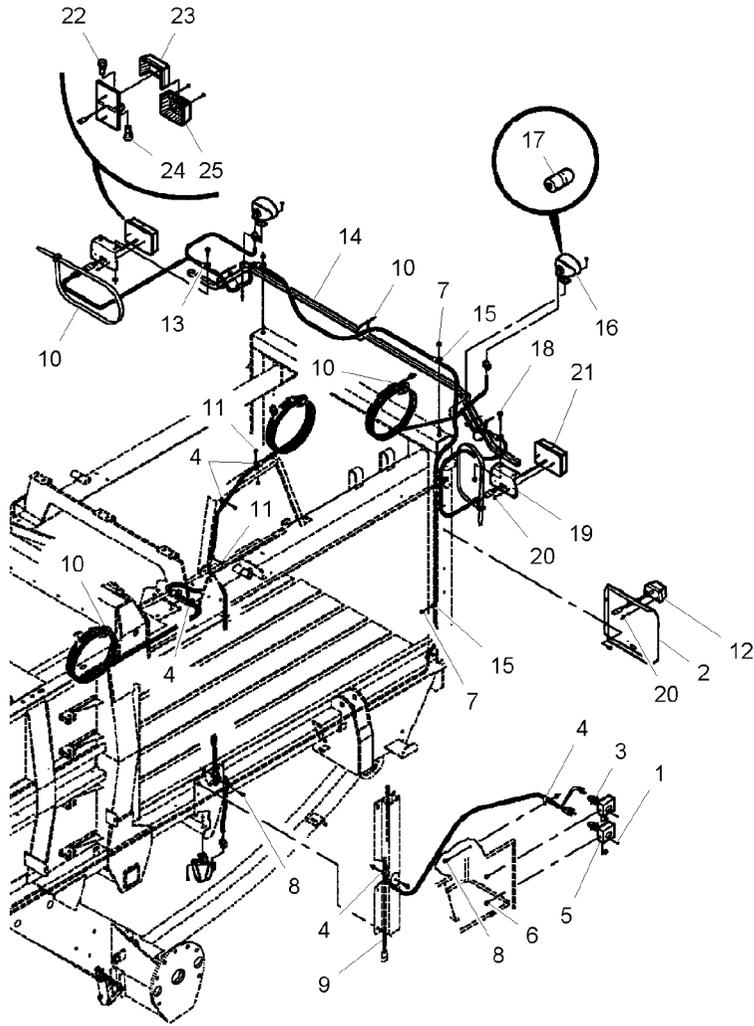

1★700710188	No 6-32 X 3/4	4 SCREW	VIS VITE	SCHRAUBE TORNILLO
1★705129	No 6	4 LOCK WASHER	RONDELLE FREIN ROSETTA DENTELL.	FEDERRING ARANDELA GROWER
2★700133747		1 SUPPORT	SUPPORT SUPPORTO	LAGERUNG DISPOS.DE SOSTEN
3★700715143		2 SWITCH	INTERRUPTEUR INTERRUPTORE	SCHALTER INTERRUPTOR
4★70926917	3/8"	6 CLAMP	COLLIER FASCETTA	HALTESCHELLE ABRAZADERA
5★700133171		2 SUPPORT	SUPPORT SUPPORTO	LAGERUNG DISPOS.DE SOSTEN
6★7883374	3/8"-16 X 3/4	2 SCREW	VIS VITE	SCHRAUBE TORNILLO
6★Y704734	3/8"-16	2 LOCKNUT	ECROU BLOCAGE AUTOBLOCCANTE	SICHERUNGSMUTTER CONTRATUERCA
7★Y704734	3/8"-16	4 LOCKNUT	ECROU BLOCAGE AUTOBLOCCANTE	SICHERUNGSMUTTER CONTRATUERCA
8★7883382	3/8"-16 X 1	2 SCREW	VIS VITE	SCHRAUBE TORNILLO
8★Y704734	3/8"-16	2 LOCKNUT	ECROU BLOCAGE AUTOBLOCCANTE	SICHERUNGSMUTTER CONTRATUERCA
9★700726143		1 HARNESS	FAISCEAU FASCIOCAVI	KABELBAUM MAZO CABLES
10★70925094		8 TIE	ATTACHE TRAVERSA ATTACCO	KUPPL.STANGE BARRA DE ENLACE
11★7883325	5/16"-18 X 3/4	2 SCREW	VIS VITE	SCHRAUBE TORNILLO
11★Y704726	5/16"-18	2 LOCKNUT	ECROU BLOCAGE AUTOBLOCCANTE	SICHERUNGSMUTTER CONTRATUERCA
12★700716772		1 LIGHT	FEU FARO	LEUCHE LAMPARA/LUZ
13★70925617	1/2"	3 CLAMP	COLLIER FASCETTA	HALTESCHELLE ABRAZADERA
14★700138851P		1 SUPPORT	SUPPORT SUPPORTO	LAGERUNG DISPOS.DE SOSTEN
15★70925619	5/8"	5 CLAMP	COLLIER FASCETTA	HALTESCHELLE ABRAZADERA
16★700726172		3 LIGHT	FEU FARO	LEUCHE LAMPARA/LUZ
17★700722351	16	1 BULB	AMPOULE BULBO	GLUEHLAMPE BOMBILLA
18★70921971	3/8"-16 X 1-3/4	6 CAPSCREW	VIS BOUCHON TAPPO A VITE	HUTSCHRAUBE TORNILLO TAPON
18★Y704734	3/8"-16	6 LOCKNUT	ECROU BLOCAGE AUTOBLOCCANTE	SICHERUNGSMUTTER CONTRATUERCA
19★700133748		2 PLATE	PLAQUE PIASTRA	PLATTE PLATO
20★705004	No 10	6 LOCK WASHER	RONDELLE FREIN ROSETTA DENTELL.	FEDERRING ARANDELA GROWER
20★7774078	M5	6 NUT	ECROU DADO	MUTTER TUERCA

Lighting Equipment
Eclairage
Beleuchtung
Equipaggiamento Illuminazione
Equipo Alumbrado

30-55

From H.K 91221 - Up To H.P 91215
A Partir Du H.K 91221 - Jusqu' Au H.P 91215
Ab H.K 91221 - Bis H.P 91215
Dalla H.K 91221 - Fino Alla H.P 91215
A Partir Del H.K 91221 - Hasta H.P 91215

5-BA49-024-A

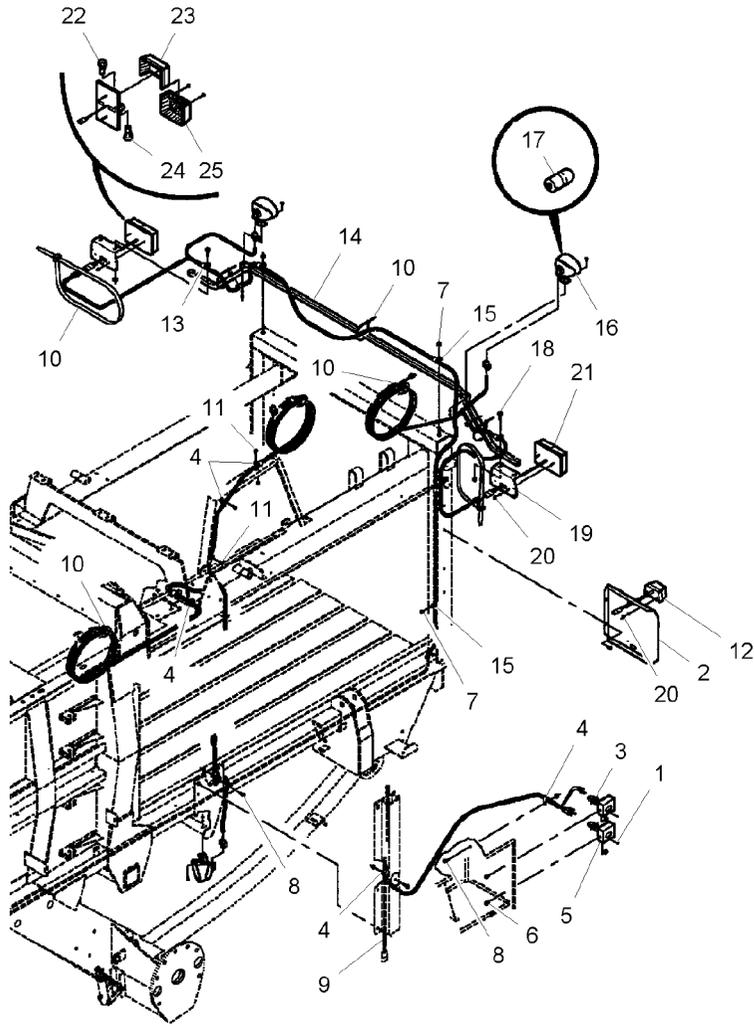

21	★700716461		2 LIGHT	FEU FARO	LEUCHTE LAMPARA/LUZ
22	★621235M1	21	1 BULB 12V 21W SBC	AMPOULE 12V 21W BULBO 12V 21W	GLUEHL 12V21WSBC BOMB 12V 21W SBC
23	★700717417	21 [A]	1 LENS	LENTILLE LENTE	LINSE LENTE DE VIDRIO
24	★908543M1	21	1 BULB S/L 21/5W	AMPOULE 21/5W BULBO 21/5W	GLUEHLAMPE 21/5W BOMB C/I 21/5W
25	★700717386	21 [B]	1 LENS	LENTILLE LENTE	LINSE LENTE DE VIDRIO

[A] ORANGE
ORANGE
ORANGE
ARANCIONE
ANARANJADO

[B] RED
ROUGE
ROT
ROSSO
ROJA

Lighting Equipment
Eclairage
Beleuchtung
Equipaggiamento Illuminazione
Equipo Alumbrado

30-60

➔ HP 91216

5-BA49-025-A

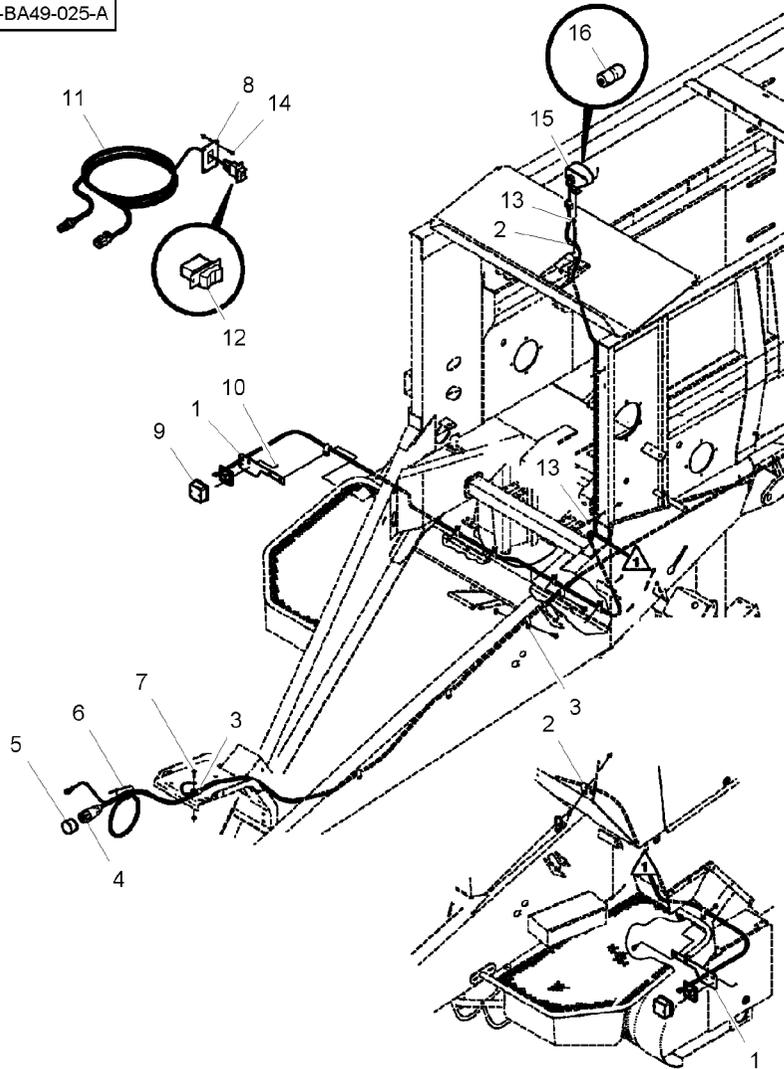

1	★700136999		1	SUPPORT	SUPPORT	LAGERUNG
2	★70926917	3/8"	5	CLAMP	SUPPORTO	DISPOS.DE SOSTEN
3	★70925619	5/8"	5	CLAMP	COLLIER	HALTESCHELLE
4	★700723782				FASCETTA	ABRAZADERA
5	★Y745216		1	HARNESS	COLLIER	HALTESCHELLE
6	★70925094				FASCETTA	ABRAZADERA
7	★7883325	5/16"-18 X 3/4	1	HARNESS	FAISCEAU	KABELBAUM
7	★Y704726	5/16"-18			FASCIOCAVI	MAZO CABLES
8	★700137047		1	CAP	CHAPEAU	KAPPE
9	★700723642				CAPUCHON	TAPA
10	★700705185	No 8-32 X 1/2	1	TIE	ATTACHE	KUPPL.STANGE
10	★70922710	No 8			TRAVERSA ATTACCO	BARRA DE ENLACE
10	★704494	No 8-32	1	SCREW	VIS	SCHRAUBE
11	★700722786				VITE	TORNILLO
12	★700723828	11	1	LOCKNUT	ECROU BLOCAGE	SICHERUNGSMUTTER
13	★7883382	3/8"-16 X 1			AUTOBLOCCANTE	CONTRATUERCA
13	★Y704734	3/8"-16	1	BRACKET	SUPPORT FIXATION	HALTEAMM
14	★700705088	No 10-24 X 3/41	2	LIGHT	STAFFETTA	SOPORTE
14	★705004	No 10			FEU	LEUCHE
14	★354120X1	No 10-24	4	SCREW	FARO	LAMPARA/LUZ
15	★700726172				VIS	SCHRAUBE
16	★700722351	15	4	LOCK WASHER	VITE	TORNILLO
					ECROU BLOCAGE	SICHERUNGSMUTTER
					AUTOBLOCCANTE	CONTRATUERCA
					VIS	SCHRAUBE
					VITE	TORNILLO
					ECROU BLOCAGE	SICHERUNGSMUTTER
					AUTOBLOCCANTE	CONTRATUERCA
					VIS	SCHRAUBE
					VITE	TORNILLO
					RONDELLE FREIN	FEDERRING
					ROSETTA DENTELL.	ARANDELA GROWER
					ECROU	MUTTER
					DADO	TUERCA
					FEU	LEUCHE
					FARO	LAMPARA/LUZ
					AMPOULE	GLUEHLAMPE
					BULBO	BOMBILLA

Lighting Equipment
Eclairage
Beleuchtung
Equipaggiamento Illuminazione
Equipo Alumbrado

30-65

➔ HP 91216

5-BA49-026-A

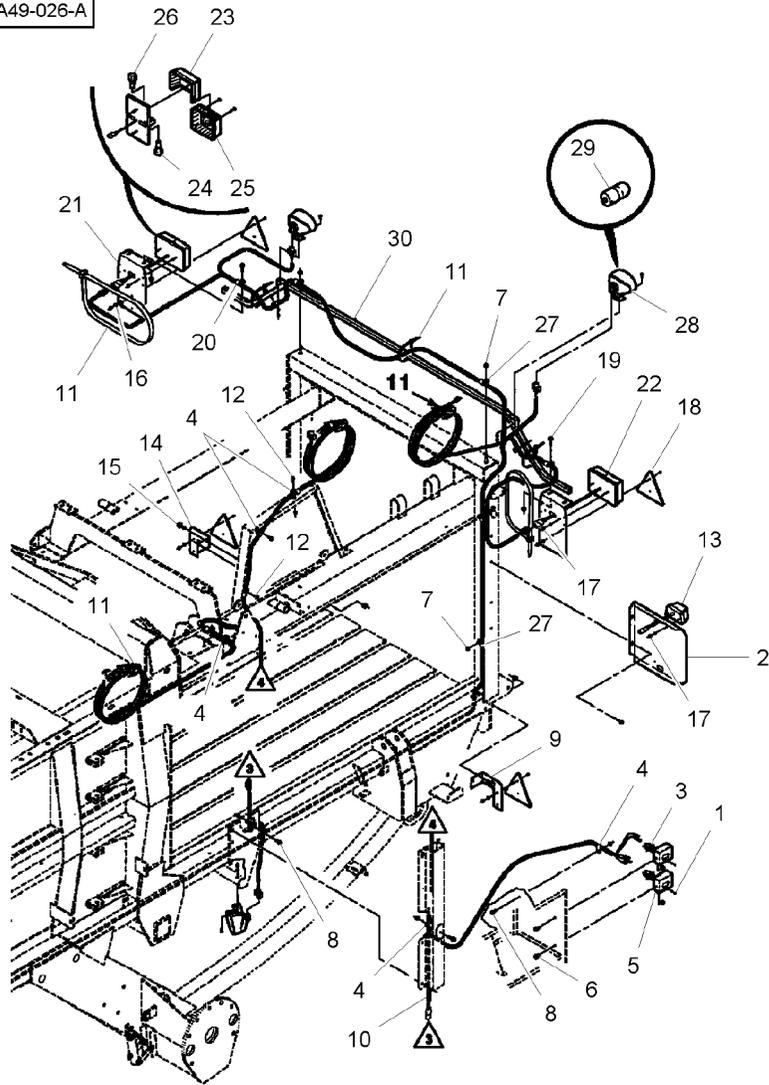

1★700710188	No 6-32 X 3/4	4 SCREW	VIS	SCHRAUBE
1★705129	No 6	4 LOCK WASHER	VITE	TORNILLO
2★700133747		1 SUPPORT	RONDELLE FREIN	FEDERRING
3★700715143		2 SWITCH	ROSETTA DENTELL.	ARANDELA GROWER
4★70926917	3/8"	6 CLAMP	SUPPORT	LAGERUNG
5★700133171		2 SUPPORT	SUPPORTO	DISPOS.DE SOSTEN
6★7883374	3/8"-16 X 3/4	2 SCREW	INTERRUPTEUR	SCHALTER
6★Y704734	3/8"-16	2 LOCKNUT	INTERRUPTORE	INTERRUPTOR
7★Y704734	3/8"-16	4 LOCKNUT	COLLIER	HALTESCHELLE
8★7883382	3/8"-16 X 1	2 SCREW	FASCETTA	ABRAZADERA
8★Y704734	3/8"-16	2 LOCKNUT	SUPPORT	LAGERUNG
9★700163376	◀	1 BRACKET	SUPPORTO	DISPOS.DE SOSTEN
10★700724844		1 HARNESS	SUPPORTO	SCHRAUBE
11★70925094		8 TIE	VIS	TORNILLO
12★7883325	5/16"-18 X 3/4	2 SCREW	VITE	SICHERUNGSMUTTER
12★Y704726	5/16"-18	2 LOCKNUT	ECROU BLOCAGE	SICHERUNGSMUTTER
13★700716772		1 LIGHT	AUTOBLOCCANTE	CONTRATUERCA
14★700163377	▶	1 BRACKET	FEU	LEUCHTE
15★700711238	3/8"-16	4 LOCKNUT	FARO	LAMPARA/LUZ
15★7883382	3/8"-16 X 1	4 SCREW	SUPPORT FIXATION	HALTEAMM
16★700705088	No 10-24 X 3/4	8 SCREW	STAFFETTA	SOPORTE
16★70917380	No 10	8 WASHER	ECROU BLOCAGE	SICHERUNGSMUTTER
16★705004	No 10	8 LOCK WASHER	AUTOBLOCCANTE	CONTRATUERCA
16★354120X1	No 10-24	8 NUT	VIS	SCHRAUBE
17★7774078	M5	6 NUT	VITE	TORNILLO
17★705004	No 10	6 LOCK WASHER	SCHRAUBE	SCHRAUBE
			VITE	TORNILLO
			RONDELLE	UNTERLEGSCHIEBE
			RONDELLA	ARANDELA
			RONDELLE FREIN	FEDERRING
			ROSETTA DENTELL.	ARANDELA GROWER
			ECROU	MUTTER
			DADO	TUERCA
			ECROU	MUTTER
			DADO	TUERCA
			RONDELLE FREIN	FEDERRING
			ROSETTA DENTELL.	ARANDELA GROWER

Lighting Equipment
Eclairage
Beleuchtung
Equipaggiamento Illuminazione
Equipo Alumbrado

30-65

➔ HP 91216

5-BA49-026-A

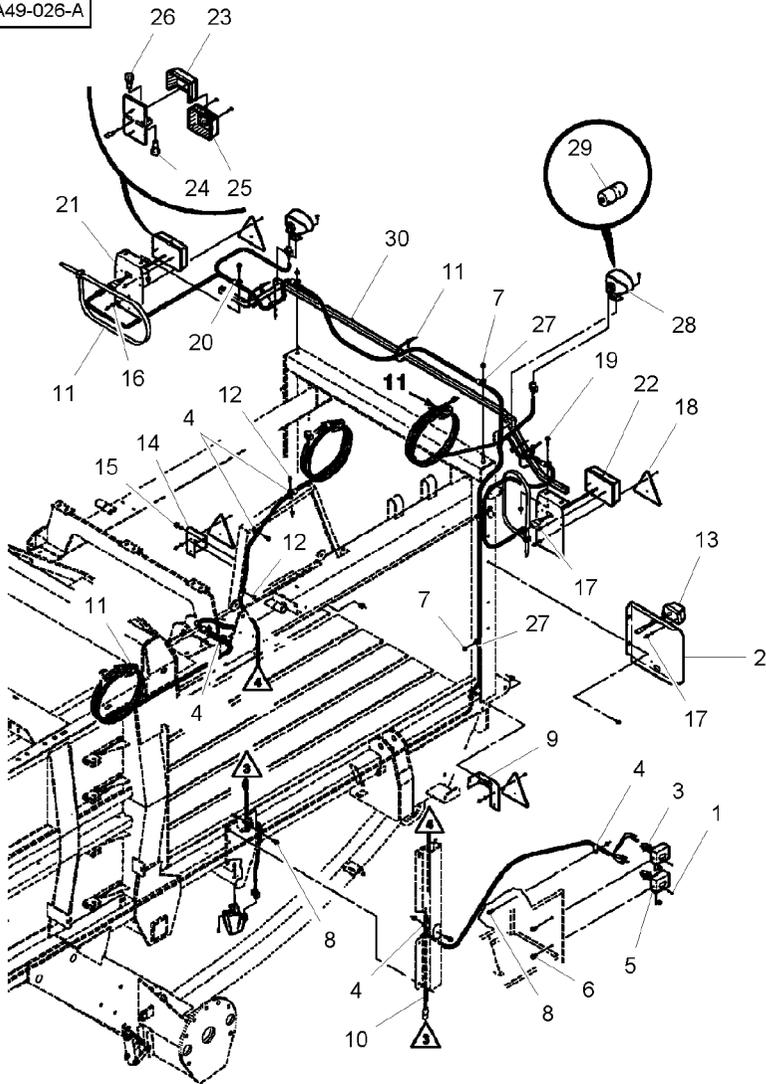

18★700722759	[A]	4 REFLECTOR	CATADIOPTRE	REFLEKTOR
19★70921971	3/8"-16 X 1-3/4	6 CAPSCREW	OJO DE GATO	CATADIOPTRICO
19★Y704734	3/8"-16	6 LOCKNUT	VIS BOUCHON	HUTSCHRAUBE
20★70925617	1/2"	3 CLAMP	TAPPO A VITE	TORNILLO TAPON
21★700133748		2 LIGHT	ECROU BLOCAGE	SICHERUNGSMUTTER
22★700716461		1 LENS	AUTOBLOCCANTE	CONTRATUERCA
23★700717417	22 [B]	1 BULB S/L 21/5W	COLLIER	HALTESCHELLE
24★908543M1	22	1 LENS	FASCETTA	ABRAZADERA
25★700717386	22 [A]	1 BULB 12V 21W SBC	PLAQUE	PLATTE
26★621235M1	22	5 CLAMP	PIASTRA	PLATO
27★70925619	5/8"	3 LIGHT	FEU	LEUCHTE
28★700726172		1 BULB	FARO	LAMPARA/LUZ
29★700722351	28	1 SUPPORT	LENTE	LINSE
30★700138851P			AMPOULE 21/5W	LENTE DE VIDRIO
			BULBO 21/5W	GLUEHLAMPE 21/5W
			BULBO 12V 21W	BOMB C/I 21/5W
			COLLIER	LINSE
			FASCETTA	LENTE DE VIDRIO
			FEU	GLUEHL 12V21WSBC
			FARO	BOMB 12V 21W SBC
			AMPOULE	HALTESCHELLE
			SUPPORT	ABRAZADERA
			SUPPORTO	LEUCHTE
				LAMPARA/LUZ
				GLUEHLAMPE
				BOMBILLA
				LAGERUNG
				DISPOS.DE SOSTEN

[A] RED
ROUGE
ROT
ROSSO
ROJA

[B] ORANGE
ORANGE
ORANGE
ARANCIONE
ANARANJADO

Lighting Equipment
Eclairage
Beleuchtung
Equipaggiamento Illuminazione
Equipo Alumbrado

30-70

➔ 190LB-50100

5 BA49 002 B

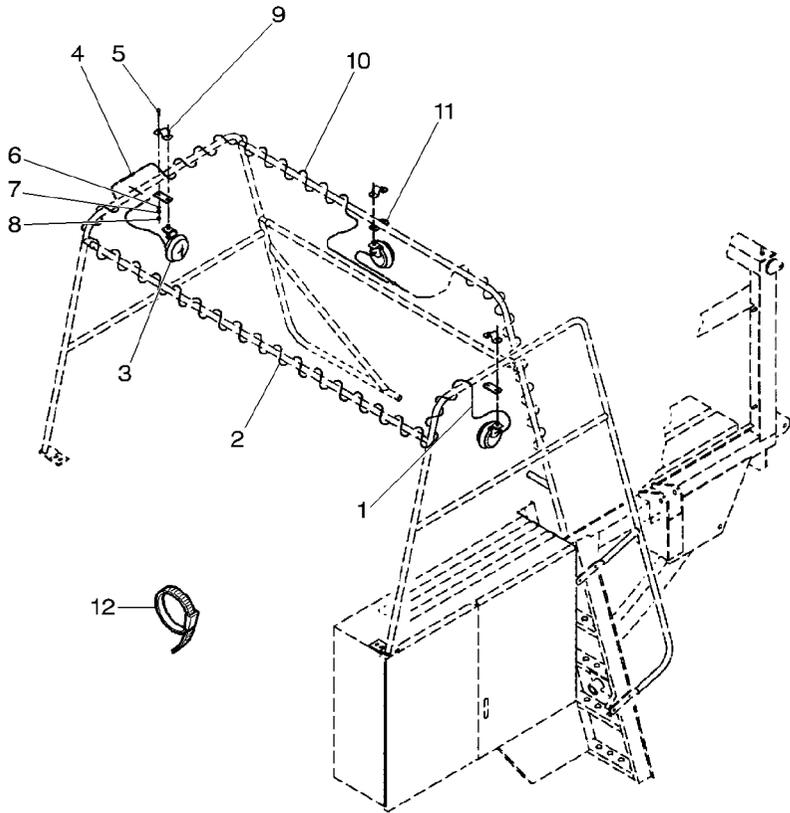

- 1 41145
- 2 700706502
- 3 **700721617**
- 4 41681
- 5 353691X1
- 6 Y705533
- 7 353434X1
- 8 355566X1
- 9 *6529739B
- 10 700706501
- 11 *6529747B
- 12 **70925094**

3/8"-16 X 1
3/8"
3/8"
3/8"-16

● UP TO 185 MB	JUSQU AU .185 MB	BIS 185 MB
	FINO ALLA 185 MB	HASTA 185 MB
1 CONNECTOR	BORNE	DOPPELNIPPEL
	MORSETTO	CONECTOR
1 WIRE	FIL	DRAHT
	CAVO ELETTRICO	HILO
3 LAMP	PHARE	SCHEINWERFER
	LAMPADINA	FARO
2 CONNECTOR	BORNE	DOPPELNIPPEL
	MORSETTO	CONECTOR
3 BOLT UNC	BOULON UNC	MASCH.SCHRB.UNC
	BULLONE UNC	PERNO UNC
3 WASHER	RONDELLE	UNTERLEGSCHIEBE
	RONDELLA	ARANDELA
3 LOCK WASHER	RONDELLE FREIN	FEDERRING
	ROSETTA DENTELL.	ARANDELA GROWER
3 NUT UNC	ECROU UNC	MUTTER UNC
	DADO UNC	TUERCA UNC
3 CLAMP	COLLIER	HALTESCHELLE
	FASCETTA	ABRAZADERA
1 WIRE	FIL	DRAHT
	CAVO ELETTRICO	HILO
3 STRAP	PATTE	LASCHE
	CORREGGIA	FAJA
X TIE	ATTACHE	KUPPL.STANGE
	TRAVERSA ATTACCO	BARRA DE ENLACE

Lighting Equipment
Eclairage
Beleuchtung
Equipaggiamento Illuminazione
Equipo Alumbrado

30-75

➔ 190LB-50101

5-BA49-015-C

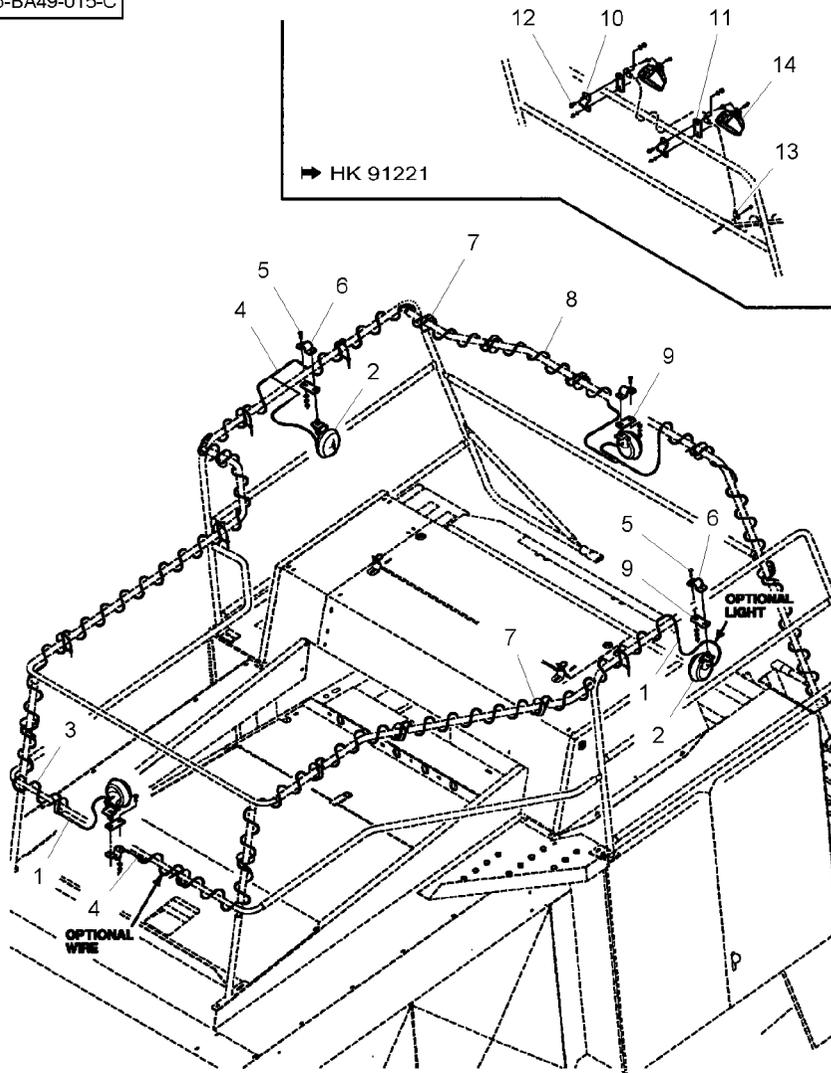

- 1 ★41145
- 2 ★700721617
- 3 ★700706502
- 4 ★41681
- 5 ★70921210
- 5 ★Y705533
- 5 ★70916965
- 5 ★70916950
- 6 ★6529739B
- 7 ★70925094
- 8 ★700706501
- 9 ★6529747B
- 10 ★6529739B
- 11 ★6529747B
- 12 ★7883382
- 12 ★Y705533
- 12 ★704247
- 13 ★70926917
- 14 ★700726172

- 3/8"-16 X 1
- 3/8"
- 3/8"
- 3/8"-16
- ➔ HK 91221
- ➔ HK 91221
- ➔ HK 91221
- ➔ HK 91221
- ➔ HK 91221
- ➔ HK 91221
- ➔ HK 91221

- 2 CONNECTOR
- 4 LAMP
- 1 WIRE
- 3 CONNECTOR
- 4 CAPSCREW
- 4 WASHER
- 4 LOCK WASHER
- 4 NUT
- 4 CLAMP
- 18 TIE
- 1 WIRE
- 4 STRAP
- 2 CLAMP
- 2 STRAP
- 2 SCREW
- 2 WASHER
- 2 NUT
- 3 CLAMP
- 2 LIGHT

- BORNE
- MORSETTO
- PHARE
- LAMPADINA
- FIL
- CAVO ELETTRICO
- BORNE
- MORSETTO
- VIS BOUCHON
- TAPPO A VITE
- RONDELLE
- RONDELLA
- RONDELLE FREIN
- ROSETTA DENTELL.
- ECROU
- DADO
- COLLIER
- FASCETTA
- ATTACHE
- TRAVERSA ATTACCO
- FIL
- CAVO ELETTRICO
- PATTE
- CORREGGIA
- COLLIER
- FASCETTA
- PATTE
- CORREGGIA
- VIS
- VITE
- RONDELLE
- RONDELLA
- ECROU
- DADO
- COLLIER
- FASCETTA
- FEU
- FARO
- DOPPELNIPPEL
- CONECTOR
- SCHWEINWERFER
- FARO
- DRAHT
- HILO
- DOPPELNIPPEL
- CONECTOR
- HUTSCHRAUBE
- TORNILLO TAPON
- UNTERLEGSCHIBE
- ARANDELA
- FEDERRING
- ARANDELA GROWER
- MUTTER
- TUERCA
- HALTESCHELLE
- ABRAZADERA
- KUPPL.STANGE
- BARRA DE ENLACE
- DRAHT
- HILO
- LASCHE
- FAJA
- HALTESCHELLE
- ABRAZADERA
- LASCHE
- FAJA
- SCHRAUBE
- TORNILLO
- UNTERLEGSCHIBE
- ARANDELA
- MUTTER
- TUERCA
- HALTESCHELLE
- ABRAZADERA
- LEUCHE
- LAMPARA/LUZ

Lighting Equipment
Eclairage
Beleuchtung
Equipaggiamento Illuminazione
Equipo Alumbrado

30-80

Rotating Light
Gyrophare
Rundumkennleucht
Luce Rotativa
Luz Giratoria

5 BA49 005 A

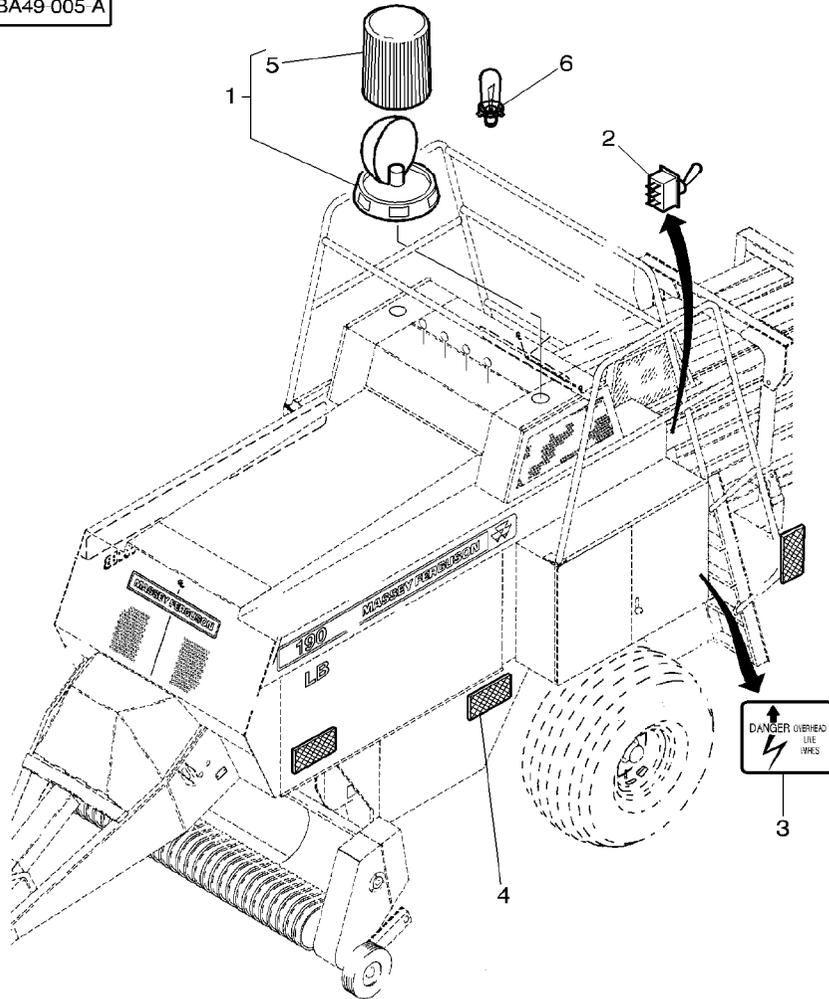

1	3901315M91		1	ROTATING LIGHT	GYROPHARE	RUNDUMKENNLEUCHT
2	3901306M1	3Position Switch	1	SWITCH	LAMPADA ROTANTE	LUZ GIRATORIA
3	3901311M91	Overhead Wire	1	WIRE	INTERRUPTEUR	SCHALTER
4	★3901310M1	[A]	6	REFLECTOR	INTERRUPTORE	INTERRUPTOR
5	3901384M1	1	1	LENS	FIL	DRAHT
6	3405180M1	55W (H1)	1	BULB 12V	CAVO ELETTRICO	HILO
					CATADIOPTRE	REFLEKTOR
					OJO DE GATO	CATADIOPTRICO
					LENTILLE	LINSE
					LENTE	LENTE DE VIDRIO
					AMPOULE 12V	GLUEHLAMPE 12V
					BULBO 12V	BOMBILLIA 12V

[A] ORANGE
ORANGE
ORANGE
ARANCIONE
ANARANJADO

Electrical
Electricite
Elektrizitat
Elettricità
Electricidad

30-85

Monitor Box
Console
Konsole
Mensola
Consola

5-BA10-002-C

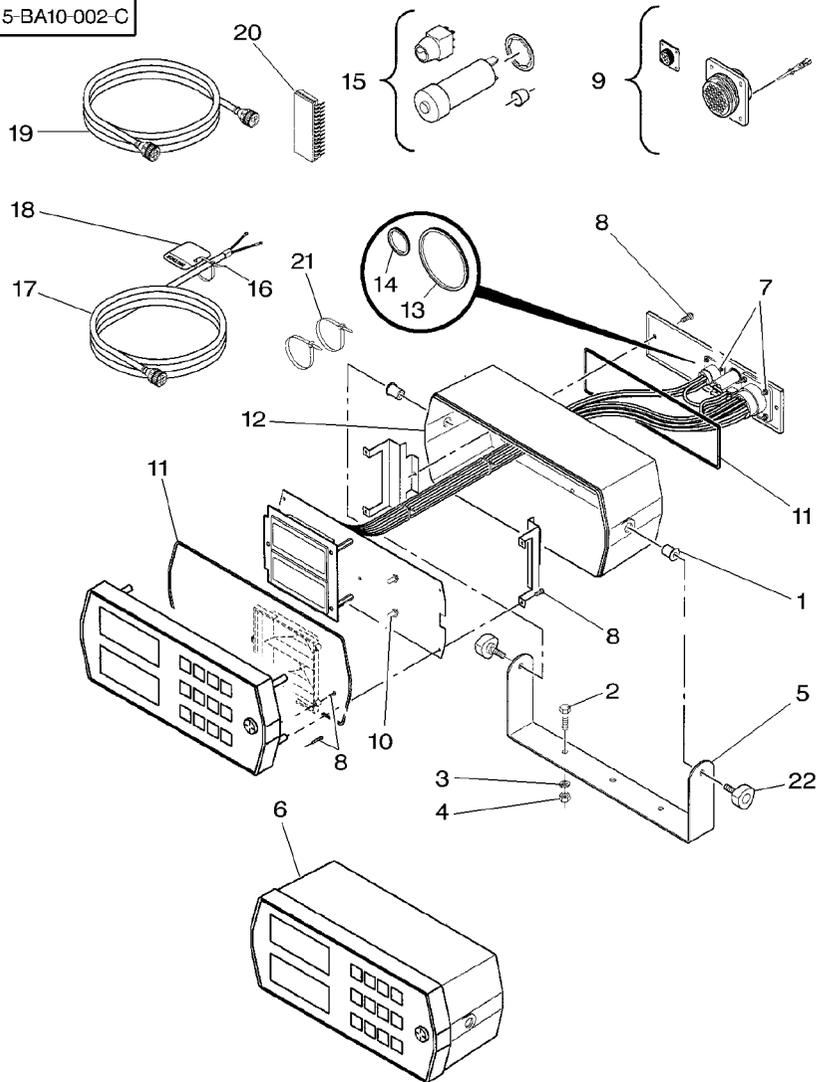

1	700707294		2	NUT	ECROU	MUTTER
2	70927401	1/4"-20 X 1			DADO	TUERCA
3	★705012	1/4"	3	CAPSCREW	VIS BOUCHON	HUTSCHRAUBE
4	★70916622	1/4"-20	3	LOCK WASHER	TAPPO A VITE	TORNILLO TAPON
5	700114077				RONDELLE FREIN	FEDERRING
6	700712845	➡ 190LB-50100	3	NUT	ROSETTA DENTELL.	ARANDELA GROWER
6	700720302	➡ 190LB-50101			ECROU	MUTTER
7	★700707377	6	1	SUPPORT	DADO	TUERCA
8	★700707378	6	1	SUPPORT	SUPPORT	LAGERUNG
9	★700712134	6	1	CONSOLE	SUPPORTO	DISPOSE.DE SOSTEN
10	★700707457	6	1	CONSOLE	CONSOLE	KONSOLE
11	★700707383	6	1	CONSOLE	CONSOLE	CONSOLA
12	★700707296	6	1	CONSOLE	CONSOLE	KONSOLE
13	★700711660	6	1	CONSOLE	CONSOLE	CONSOLA
14	★700712102	6	1	JEU	JEU	SATZ
15	★700707382	6	1	KIT	KIT	JUEGO
16	70932747		1	KIT	JEU	SATZ
17	700707598		1	KIT, REPAIR	KIT	JUEGO
18	700707683		3	LAMP	JEU REPARATION	REPARATURSATZ
19	700712135				KIT RIPARAZIONE	JUEGO REPARACION
20	700124049	➡ 190LB-50100	1	GASKET	PHARE	SCHEINWERFER
21	70925094				LAMPADINA	FARO
22	700707295		1	COVER	JOINT	DICHTSCHEIBE
			1	COVER	GUARNIZIONE	EMPAQUETADURA.
			1	SEAL	COUVERCLE	DECKEL
			1	SEAL	COPERCHIO	CUBIERTA
			1	SEAL	JOINT ETANCHEITE	DICHTRING
			1	SEAL	ANELLO RACCORD	ARENDELA D'JUNTA
			1	SEAL	JOINT ETANCHEITE	DICHTRING
			1	SEAL	ANELLO RACCORD	ARENDELA D'JUNTA
			1	KIT, REPAIR	JEU REPARATION	REPARATURSATZ
			1	CABLE TIE	KIT RIPARAZIONE	JUEGO REPARACION
			1	CABLE	ATTACHE CABLE	KABELBINDER
			1	CABLE	FASCETTA CAVI	APRIETACABLES
			1	CABLE	CABLE	KABEL
			1	DECAL	CAVO	CABLE
			1	DECAL	DECALCOMANIE	AUFKLEBER
			1	DECAL	DECALCOMANIA	CALCOMANIA
			1	DECAL	CABLE	KABEL
			1	DECAL	CAVO	CABLE
			1	DECAL	JEU	SATZ
			1	DECAL	JEU	JUEGO
			2	TIE	KIT	JUEGO
			2	TIE	ATTACHE	KUPPL.STANGE
			2	TIE	TRAVERSA ATTACCO	BARRA DE ENLACE
			2	TIE	POMMEAU	KNOPF
			2	TIE	POMELO	POMO

Electrical
 Electricite
 Elektrizitat
 Eletricita
 Electricidad

30-90

Kit
 Kit
 Kit
 Kit
 Kit

5-BA10-003-B

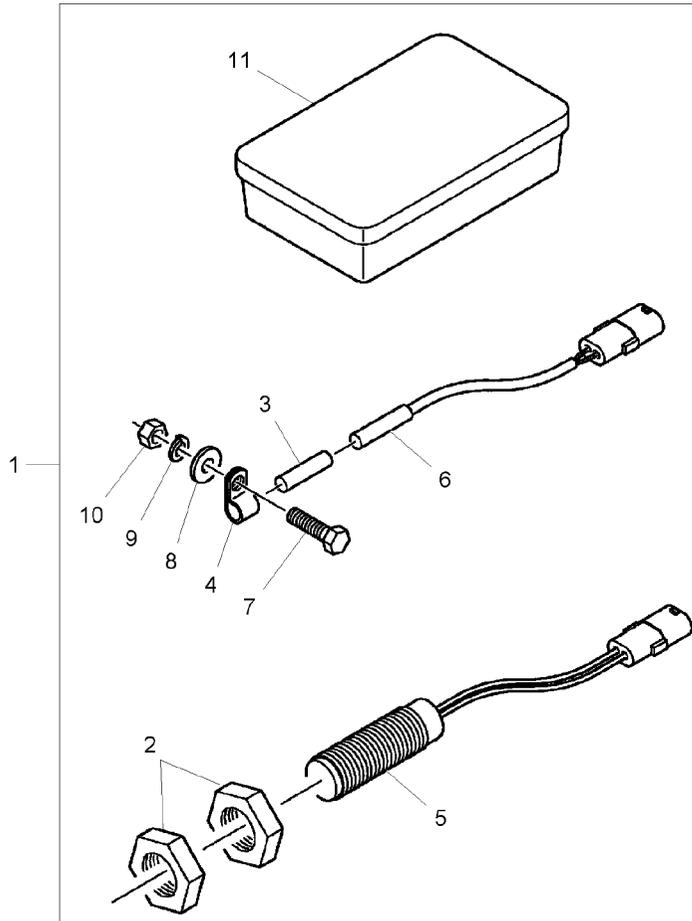

1	700114076		1	KIT, ATTACHMENT	JEU ACCESSOIRES KIT ACCESSORI	SATZ ANBAUTEILE JUEGO ACCESORIO
2	353436X1	1	3/4"-16	2 NUT UNF	ECROU UNF DADO UNF	MUTTER UNF TUERCA UNF
3	700706340	1		1 MAGNET	AIMANT MAGNETE	MAGNET IMAN
4	70926919	1	1/4"	1 CLAMP	COLLIER FASCETTA	HALTESCHELLE ABRAZADERA
5	700706398	1		1 SENSOR	DETECTEUR SENSORE	EMPFANGER DETECTOR
6	700113863	1		1 SWITCH	INTERRUPTEUR INTERRUPTORE	SCHALTER INTERRUPTOR
7	70927401	1	1/4"-20 X 1	1 CAPSCREW	VIS BOUCHON TAPPO A VITE	HUTSCHRAUBE TORNILLO TAPON
8	353769X1	1	1/4"	1 WASHER	RONDELLE RONDELLA	UNTERLEGSCHIEBE ARANDELA
9	705012	1	1/4"	1 LOCK WASHER	RONDELLE FREIN ROSETTA DENTELL.	FEDERRING ARANDELA GROWER
10	70916622	1	1/4"-20	1 NUT	ECROU DADO	MUTTER TUERCA
11	700707474	1		1 BOX	BOITE SCATOLA	DOSE CAJA

Electrical
 Electricite
 Elektrizitat
 Elettricita
 Electricidad

30-95

Kit - With Electronic Control
 Kit - Avec Controle Electronique
 Kit - Mit Elektronische Steuerung
 Kit - Con Controllo Elettronico
 Kit - Con Control Electronico

5-BA10-026-A

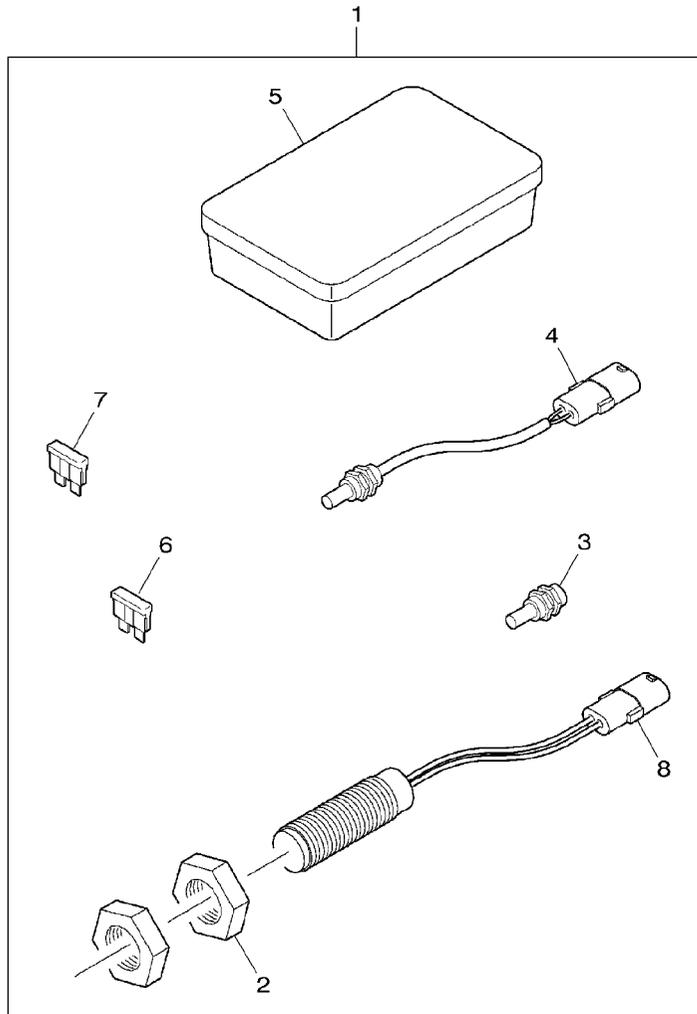

1	700154471		1 KIT, REPAIR	JEU REPARATION	REPARATURSATZ
2	353436X1	1 3/4"-16	2 NUT UNF	KIT RIPARAZIONE	JUEGO REPARACION
3	700710211	1	1 ACTUATOR	ECROU UNF	MUTTER UNF
4	700119161	1	1 SWITCH	DADO UNF	TUERCA UNF
5	700707474	1	1 BOX	DECLENCHEUR	BETAETIGUNG
6	3387318M1	1 5 Amp	2 FUSE	AZIONATORE	ACCIONAMIENTO
7	1695966M1	1 15 Amp	2 FUSE	INTERRUPTEUR	SCHALTER
8	700706398	1	1 SENSOR	INTERRUTTORE	INTERRUPTOR
				BOITE	DOSE
				SCATOLA	CAJA
				FUSIBLE	SICHERUNG
				VALVOLINA	FUSIBLE
				FUSIBLE	SICHERUNG
				VALVOLINA	FUSIBLE
				DETECTEUR	EMPFANGER
				SENSORE	DETECTOR

Electrical Plug
 Prise Electrique
 Elektrischer Stecker
 Presaelettricità
 Tomacorriente

30-100

5-BA64-020-B

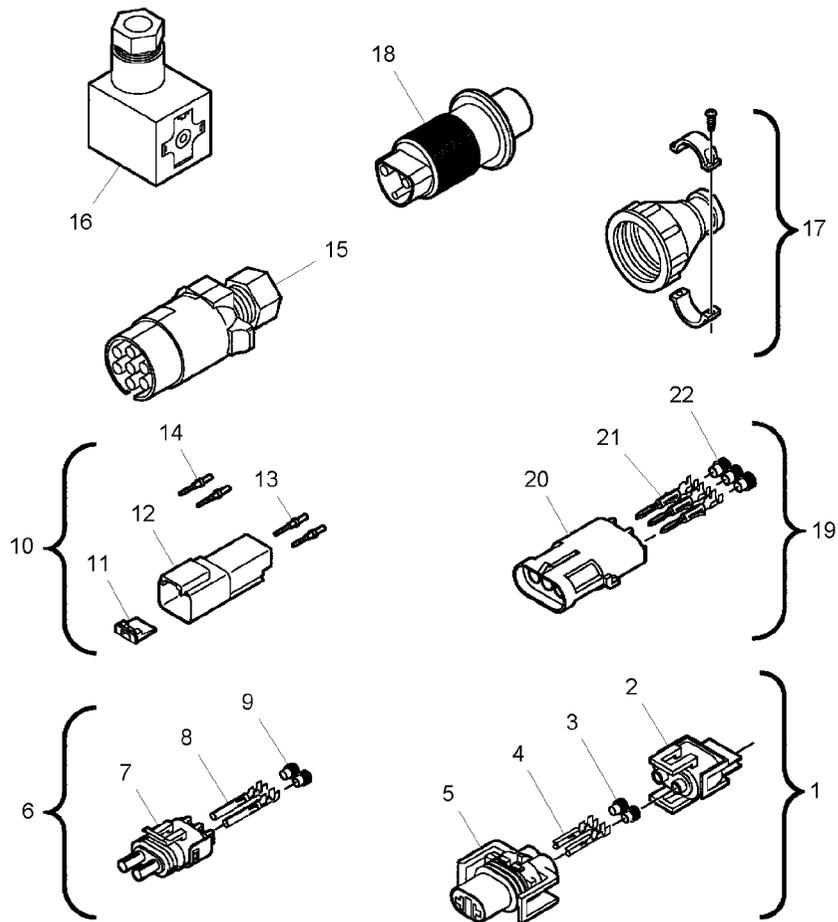

1	★700726147		1 KIT, REPAIR	JEU REPARATION	REPARATURSATZ
2	★700725528	1	1 CONNECTOR	KIT RIPARAZIONE	JUEGO REPARACION
3	★700706400	1	2 SEAL	BORNE	DOPPELNIPPEL
4	★700725529	1	2 TERMINAL	MORSETTO	CONECTOR
5	★700725527	1	1 CONNECTOR	JOINT ETANCHEITE	DICHTRING
6	★700718590		1 KIT, REPAIR	ANELLO RACCORD	ARENDELA D'JUNTA
7	★700708761	6	1 CONNECTOR	TERMINALE	TERMINAL
8	★700718576	6	2 CONNECTOR	TERMINALE	TERMINAL
9	★700712467	6	2 SEAL	BORNE	DOPPELNIPPEL
10	★700723223		1 KIT, REPAIR	MORSETTO	CONECTOR
11	★700723222	10	1 CLIP	JEU REPARATION	REPARATURSATZ
12	★71399389	10	1 CONNECTOR	KIT RIPARAZIONE	JUEGO REPARACION
13	★700723220	10 (14-16)	2 CONTACT PIN	BORNE	DOPPELNIPPEL
14	★700719869	10 (16-18)	2 CONTACT PIN	MORSETTO	CONECTOR
15	★1427996M1		1 PLUG 7 PIN SUP	AXE DE CONTACT	KONTAKTSTIFT
16	★700720804		1 CONNECTOR	CONTACT PIN	CLAVIJA CONTACTO
17	★700709233	(SIZE 11)	1 CLAMP	AXE DE CONTACT	KONTAKTSTIFT
18	★3760032M1		1 ELECTRICAL PLUG	CONTACT PIN	CLAVIJA CONTACTO
19	★700718531		1 KIT, REPAIR	PRISE MALE 7 BR	STECKER 7P ENTST
20	★700706413	19	1 CONNECTOR	SPINA DA 7	TOMA 7 ESPIG SUP
21	★700718530	19	3 CONNECTOR	BORNE	DOPPELNIPPEL
22	★700712467	19	3 SEAL	MORSETTO	CONECTOR
				COLLIER	HALTESCHELLE
				FASCETTA	ABRAZADERA
				PRISE ELECT MALE	STECKER
				PRESAELETRICI M	TOMACORRIENTE M
				JEU REPARATION	REPARATURSATZ
				KIT RIPARAZIONE	JUEGO REPARACION
				BORNE	DOPPELNIPPEL
				MORSETTO	CONECTOR
				BORNE	DOPPELNIPPEL
				MORSETTO	CONECTOR
				JOINT ETANCHEITE	DICHTRING
				ANELLO RACCORD	ARENDELA D'JUNTA

Electrical Plug
Prise Electrique
Elektrischer Stecker
Presaelettricità
Tomacorriente

30-105

5-BA64-007-B

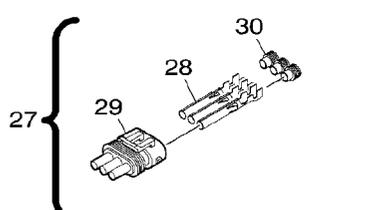
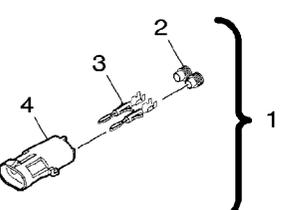
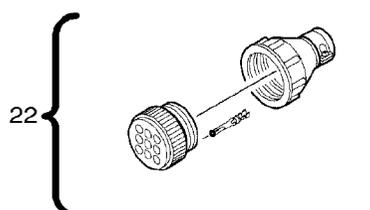
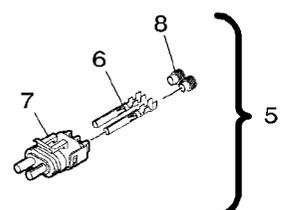
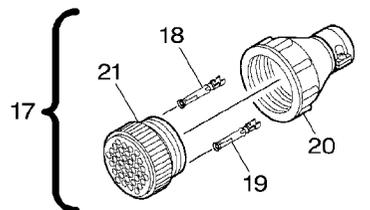
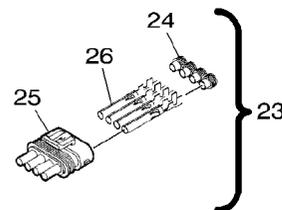
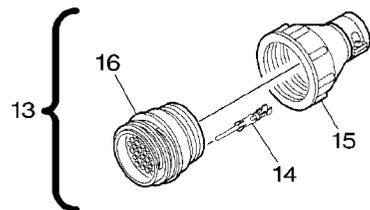
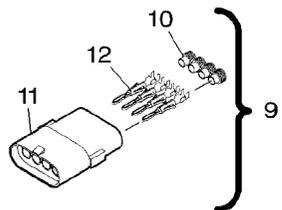

1	700708753		1	KIT, REPAIR	JEU REPARATION	REPARATURSATZ
2	700706400	1	2	SEAL	KIT RIPARAZIONE	JUEGO REPARACION
3	700706401	1 (18-20 GAUGE)	2	TERMINAL	JOINT ETANCHEITE	DICHTRING
4	700706399	1			ANELLO RACCORD	ARENDELA D'JUNTA
5	700706999		1	CONNECTOR	TERMINAL.	TERMINAL
6	700708760	5 (18-20 GAUGE)	1	CONNECTOR	TERMINALE	TERMINAL
7	700708761	5	1	CONNECTOR	BORNE	DOPPELNIPPEL
8	700706400	5	2	SEAL	MORSETTO	CONECTOR
9	700709354		1	KIT, REPAIR	JEU REPARATION	REPARATURSATZ
10	700706400	9	4	SEAL	KIT RIPARAZIONE	JUEGO REPARACION
11	700708964	9	1	CONNECTOR	JOINT ETANCHEITE	DICHTRING
12	700706401	9	1	CONNECTOR	ANELLO RACCORD	ARENDELA D'JUNTA
13	700707003		4	TERMINAL	BORNE	DOPPELNIPPEL
14	700718605	13	1	KIT, REPAIR	MORSETTO	CONECTOR
15	700709911	13	1	KIT, REPAIR	TERMINAL.	TERMINAL
16	700718604	13	1	CONNECTOR	TERMINALE	TERMINAL
17	700707004		1	KIT, REPAIR	JEU REPARATION	REPARATURSATZ
18	700718608	17	37	CONNECTOR	KIT RIPARAZIONE	JUEGO REPARACION
19	700718607	17	1	BODY	BORNE	DOPPELNIPPEL
20	72514691	17	1	PLUG	MORSETTO	CONECTOR
21	72514681	17	1	CONNECTOR	BORNE	DOPPELNIPPEL
22	1713981		1	KIT, REPAIR	MORSETTO	CONECTOR
23	700707002		1	KIT, REPAIR	CORPS	RUMPF
24	700706400	23	1	KIT, REPAIR	CORPO	CUERPO
25	700708963	23	1	CONNECTOR	BOUCHON	VERSCHL.STOPFEN
26	700708760	23 (18-20 GAUGE)	1	CONNECTOR	TAPPO	TAPON
			1	KIT, REPAIR	JEU REPARATION	REPARATURSATZ
			1	KIT, REPAIR	KIT RIPARAZIONE	JUEGO REPARACION
			4	SEAL	BORNE	DOPPELNIPPEL
			1	CONNECTOR	MORSETTO	CONECTOR
			4	TERMINAL	TERMINAL.	TERMINAL
			2	SEAL	TERMINALE	TERMINAL

Electrical Plug
 Prise Electrique
 Elektrischer Stecker
 Presaelettricità
 Tomacorriente

30-105

5-BA64-007-B

27 700707001

1 KIT, REPAIR

JEU REPARATION
 KIT RIPARAZIONE

REPARATURSATZ
 JUEGO REPARACION

28 700708760

27 (18-20 GAUGE)

3 TERMINAL

TERMINALE

TERMINAL

29 700709175

27

1 CONNECTOR

BORNE
 MORSETTO

DOPPELNIPPEL
 CONECTOR

30 700706400

27

3 SEAL

JOINT ETANCHEITE
 ANELLO RACCORD

DICHTRING
 ARENELA D'JUNTA

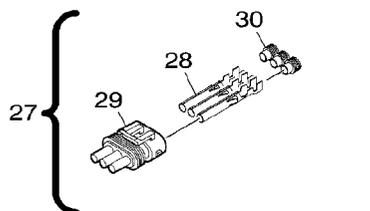
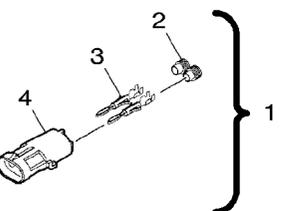
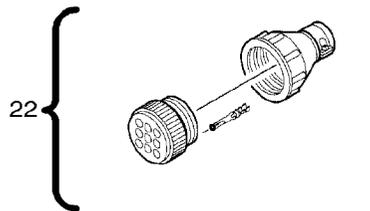
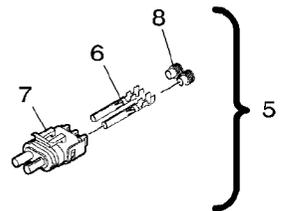
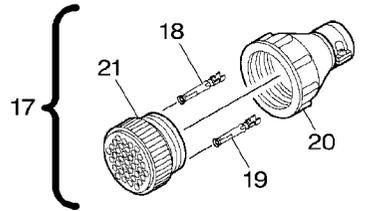
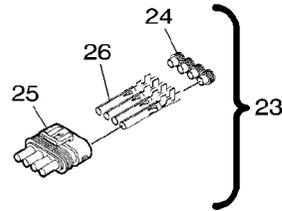
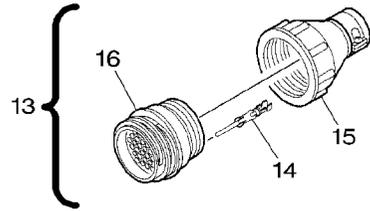
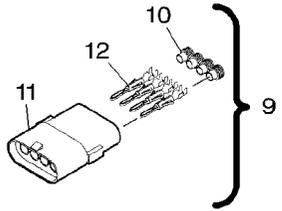

Electrical Plug
 Prise Electrique
 Elektrischer Stecker
 Presaelettricità
 Tomacorriente

30-110

5-BA64-019-B

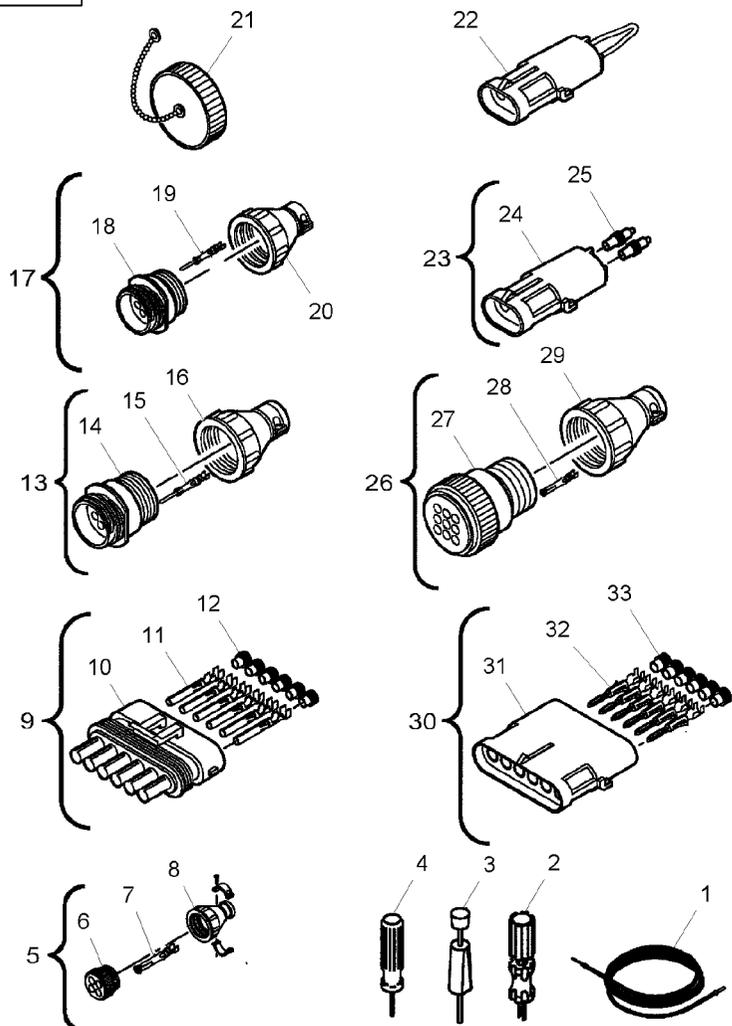

1	★700708333		1 WIRE	FIL	DRAHT
2	★700707014		1 TOOL	CAVO ELETTRICO	HILO
3	★700707013		1 TOOL	OUTIL	WERKZEUG
4	★700707012		1 TOOL	ATTREZZO	HERRAMIENTA
5	★700712132		1 KIT, REPAIR	OUTIL	WERKZEUG
6	★700709232	5	1 PLUG	ATTREZZO	HERRAMIENTA
7	★700708758	5	4 CONNECTOR	JEU REPARATION	REPARATURSATZ
8	★700709233	5	1 CLAMP	KIT RIPARAZIONE	JUEGO REPARACION
9	★700718614		1 KIT, REPAIR	BOUCHON	VERSCHL.STOPFEN
10	★700718581	9	1 CONNECTORS	TAPPO	TAPON
11	★700708760	9	6 TERMINAL	BORNE	DOPPELNIPPEL
12	★700706400	9	6 SEAL	MORSETTO	CONECTOR
13	★700718618		1 KIT, REPAIR	COLLIER	HALTESCHELLE
14	★72514685	13	1 CONNECTOR	FASCETTA	ABRAZADERA
15	★700708757	13	9 PIN	JEU REPARATION	REPARATURSATZ
16	★700709708	13	1 CLAMP	KIT RIPARAZIONE	JUEGO REPARACION
17	★1713973		1 KIT, REPAIR	CONNECTEUR	KABELVERBINDER
18	★72514685	17	1 CONNECTOR	MORSETTI	CONECTADORES
19	★700718605	17	9 CONNECTOR	TERMINALE	TERMINAL
20	★700709708	17	1 CLAMP	TERMINALE	TERMINAL
21	★700719614		1 CAP	JOINT ETANCHEITE	DICHTRING
22	★700716454		1 ELECTRICAL PLUG	ANELLO RACCORD	ARENDELA D'JUNTA
23	★700716345		1 KIT, REPAIR	JEU REPARATION	REPARATURSATZ
24	★700706399	23	1 CONNECTOR	KIT RIPARAZIONE	JUEGO REPARACION
25	★700714829	23	2 PLUG	BORNE	DOPPELNIPPEL
26	★700718683		1 KIT, REPAIR	MORSETTO	CONECTOR
				BOUCHON	VERSCHL.STOPFEN
				TAPPO	TAPON
				JEU REPARATION	REPARATURSATZ
				KIT RIPARAZIONE	JUEGO REPARACION

Electrical Plug
 Prise Electrique
 Elektrischer Stecker
 Presaelettricità
 Tomacorriente

30-110

5-BA64-019-B

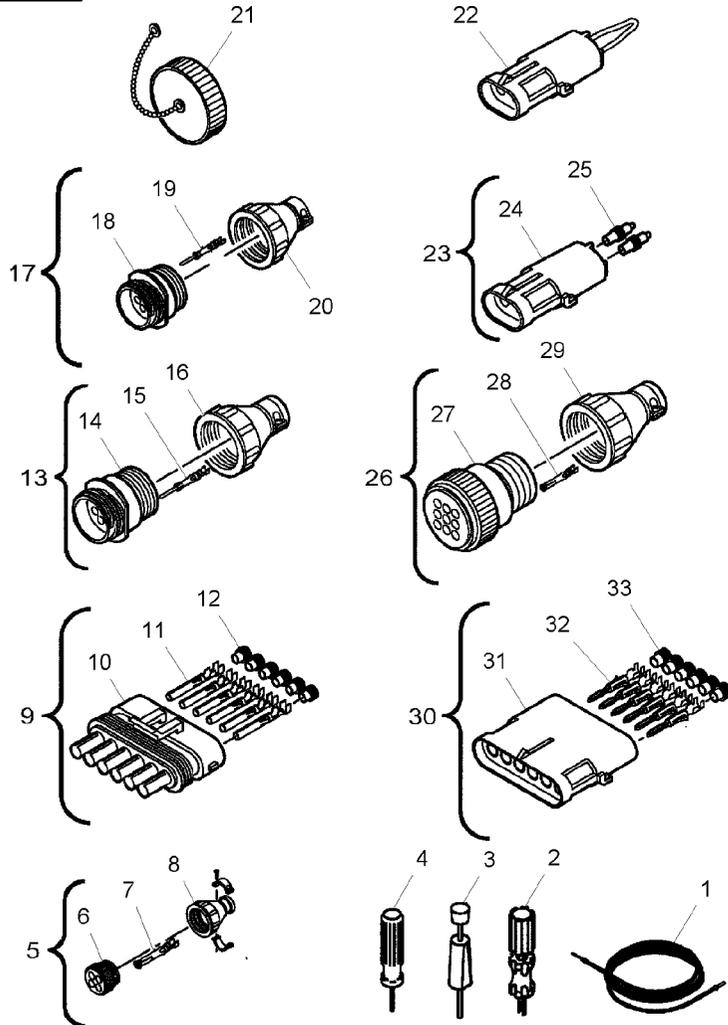

27★700709704	26	1 PLUG	BOUCHON	VERSCHL.STOPFEN
28★700708758	26	9 CONNECTOR	TAPPO	TAPON
29★700709708	26	1 CLAMP	BORNE	DOPPELNIPPEL
30★700718613		1 KIT, REPAIR	MORSETTO	CONECTOR
31★700718638	30	1 CONNECTOR	COLLIER	HALTESCHELLE
32★700706401	30	6 TERMINAL	FASCETTA	ABRAZADERA
33★700706400	30	6 SEAL	JEU REPARATION	REPARATURSATZ
			KIT RIPARAZIONE	JUEGO REPARACION
			BORNE	DOPPELNIPPEL
			MORSETTO	CONECTOR
			TERMINAL	TERMINAL
			TERMINALE	TERMINAL
			JOINT ETANCHEITE	DICHTRING
			ANELLO RACCORD	ARENDELA D'JUNTA

Electrical Plug
Prise Electrique
Elektrischer Stecker
Presaelettricità
Tomacorriente

30-115

5-BA64-014-C

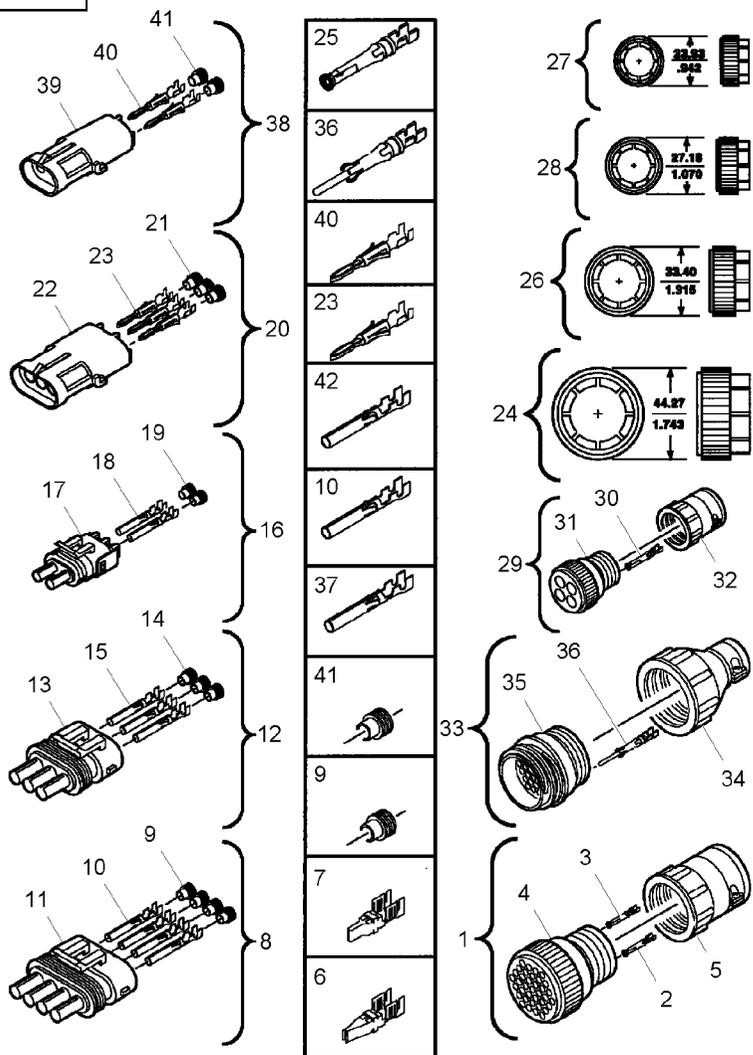

1★700707004		1 KIT, REPAIR	JEU REPARATION	REPARATURSATZ
2★700718607	1 (14-18 GAUGE)	50 CONNECTOR	KIT RIPARAZIONE	JUEGO REPARACION
3★700718608	1 (20-24 GAUGE)	50 CONNECTOR	BORNE	DOPPELNIPPEL
4★72514681	1	1 CONNECTOR	MORSETTO	CONECTOR
5★72514691	1 (SIZE 23)	1 BODY	BORNE	DOPPELNIPPEL
6★700709706	(10-8 GAUGE)	1 CONTACT	MORSETTO	CONECTOR
7★700710620	(16-12 GAUGE)	1 CONTACT	CORPS	RUMPF
8★700707002		1 KIT, REPAIR	CORPO	CUERPO
9★700706400	8	1 CONTACT	RUPTEUR	KONTAKT
10★700708760	8	1 CONTACT	CONTATTO	CONTACTO
11★700708963	8	1 CONTACT	RUPTEUR	KONTAKT
12★700707001		1 KIT, REPAIR	CONTATTO	CONTACTO
13★700709175	12	1 KIT, REPAIR	JEU REPARATION	REPARATURSATZ
14★700706400	12	4 SEAL	KIT RIPARAZIONE	JUEGO REPARACION
15★700708760	12	4 SEAL	JOINT ETANCHEITE	DICHTRING
16★700706999		4 TERMINAL	ANELLO RACCORD	ARENDELA D'JUNTA
17★700708761	16	1 CONNECTOR	TERMINAL.	TERMINAL
18★700708760	16	1 CONNECTOR	TERMINALE	TERMINAL
19★700706400	16	1 KIT, REPAIR	BORNE	DOPPELNIPPEL
20★700719282	(22 GAUGE)	1 KIT, REPAIR	MORSETTO	CONECTOR
21★700706415	20 (22 GAUGE)	1 CONNECTOR	JEU REPARATION	REPARATURSATZ
22★700706413	20 (3 PIN)	3 SEAL	KIT RIPARAZIONE	JUEGO REPARACION
23★700706414	20 (22 GAUGE)	3 SEAL	JOINT ETANCHEITE	DICHTRING
24★700707820		1 CONNECTOR	ANELLO RACCORD	ARENDELA D'JUNTA
25★700708758	(16-18 GAUGE)	1 RING	BORNE	DOPPELNIPPEL
26★700707819		1 RING	MORSETTO	CONECTOR
			ANNEAU	RING
			ANELLO	ARO
			BORNE	DOPPELNIPPEL
			MORSETTO	CONECTOR
			ANNEAU	RING
			ANELLO	ARO

Electrical Plug
 Prise Electrique
 Elektrischer Stecker
 Presaelettricità
 Tomacorriente

30-115

5-BA64-014-C

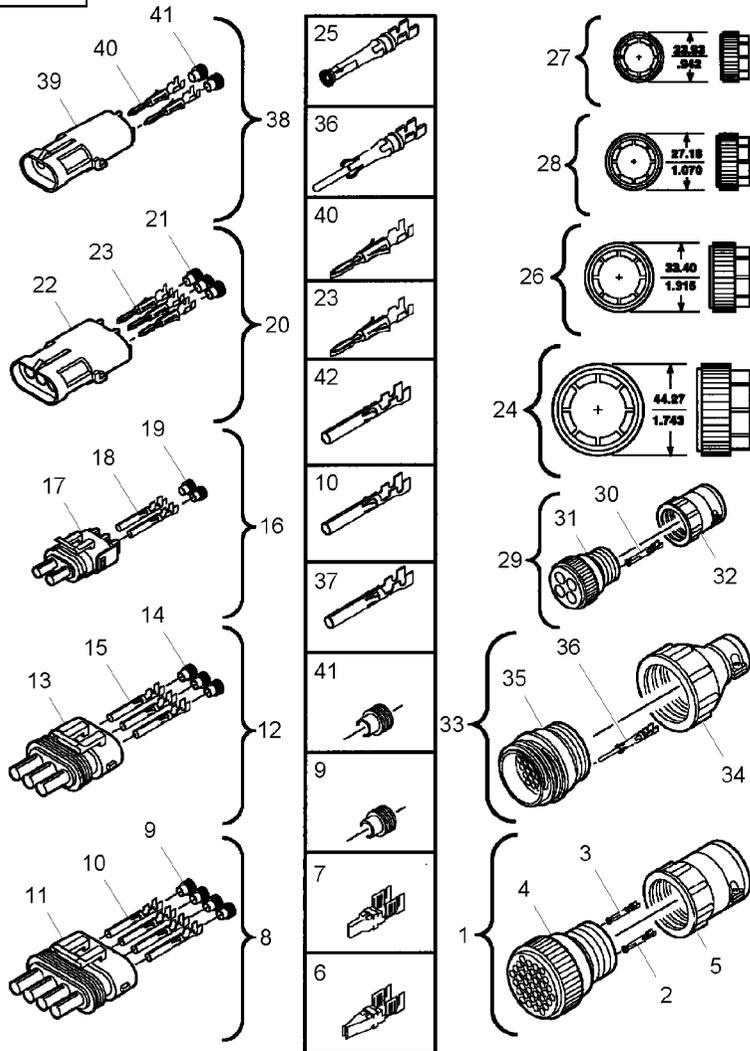

27★700707817		1 RING	ANNEAU	RING
28★700707818		1 RING	ANELLO	ARO
29★700712132		1 KIT, REPAIR	JEU REPARATION	REPARATURSATZ
30★700718607	29	4 CONNECTOR	KIT RIPARAZIONE	JUEGO REPARACION
31★700709232	29	1 PLUG	BORNE	DOPPELNIPPEL
32★700713576	29	1 CLAMP	MORSETTO	CONECTOR
33★700707003	29	1 KIT, REPAIR	BOUCHON	VERSCHL.STOPFEN
34★700709911	33 (SIZE 23)	1 BODY	TAPPO	TAPON
35★700718604	33 (37 PIN)	1 PLUG	COLLIER	HALTESCHELLE
36★700718605	33 (20-24 GAUGE)	50 CONNECTOR	FASCETTA	ABRAZADERA
37★700718576	(16 GAUGE)	1 CONNECTOR	JEU REPARATION	REPARATURSATZ
38★700718588	(16 GAUGE)	1 KIT, REPAIR	KIT RIPARAZIONE	JUEGO REPARACION
39★700706399	38 (2 PIN)	1 CONNECTOR	MORSETTO	DOPPELNIPPEL
40★700718530	38 (16 GAUGE)	2 CONNECTOR	BOUCHON	CONECTOR
41★700712467	38 (16 GAUGE)	2 SEAL	TAPPO	DOPPELNIPPEL
42★700721062		1 CONNECTOR	MORSETTO	CONECTOR
			JOINT ETANCHEITE	DICHTRING
			ANELLO RACCORD	ARENDELA D'JUNTA
			BORNE	DOPPELNIPPEL
			MORSETTO	CONECTOR

Electrical Plug
Prise Electrique
Elektrischer Stecker
Presaelettricità
Tomacorriente

30-120

5-BA64-012-B

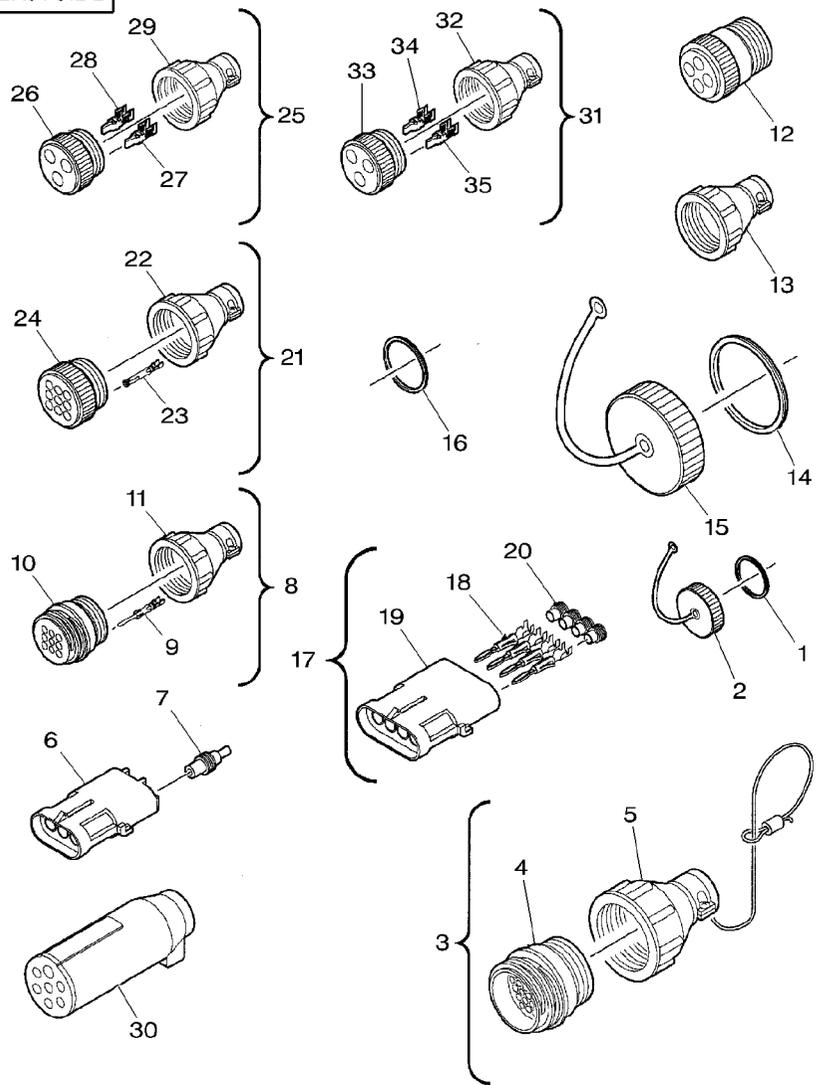

1	★700712896	(SIZE 13)	1 SEAL	JOINT ETANCHEITE	DICHRING
2	★700707016	(SIZE 13)	1 CAP	ANELLO RACCORD	ARENDELA D'JUNTA
3	★700713300		1 PLUG	CHAPEAU	KAPPE
4	700719293	3	1 CONNECTOR	CAPUCHON	TAPA
5	700709911	3	1 BODY	BOUCHON	VERSCHL.STOPFEN
6	★700706413		1 CONNECTOR	TAPPO	TAPON
7	★700714829		3 PLUG	BORNE	DOPPELNIPPEL
8	★1713973		1 KIT, REPAIR	MORSETTO	CONECTOR
9	★700718605	8	9 CONNECTOR	CORPS	RUMPF
10	★72514685	8	1 CONNECTOR	CORPO	CUERPO
11	700709708	8	1 CLAMP	BORNE	DOPPELNIPPEL
12	★700709232		1 PLUG	MORSETTO	CONECTOR
13	★700709233		1 CLAMP	BORNE	DOPPELNIPPEL
14	★700711660	(SIZE 23)	1 SEAL	MORSETTO	CONECTOR
15	★700712983	(SIZE 23)	1 CAP	COLLIER	HALTESCHELLE
16	★700711829		1 SEAL	FASCETTA	ABRAZADERA
17	★700709354		1 KIT, REPAIR	BOUCHON	VERSCHL.STOPFEN
18	700706401	17	4 TERMINAL	TAPPO	TAPON
19	700708964	17	1 CONNECTOR	COLLIER	HALTESCHELLE
20	700706400	17	4 SEAL	FASCETTA	ABRAZADERA
21	★1713981		1 KIT, REPAIR	BOUCHON	VERSCHL.STOPFEN
22	700709708	21	1 CLAMP	TAPPO	TAPON
23	700718608	21	9 CONNECTOR	JEU REPARATION	REPARATURSATZ
24	700709704	21	1 PLUG	KIT RIPARAZIONE	JUEGO REPARACION
25	★1714005		1 KIT, REPAIR	TERMINALE	TERMINAL
26	700709705	25	1 PLUG	BORNE	DOPPELNIPPEL
				MORSETTO	CONECTOR
				BOUCHON	VERSCHL.STOPFEN
				TAPPO	TAPON
				JEU REPARATION	REPARATURSATZ
				KIT RIPARAZIONE	JUEGO REPARACION
				BOUCHON	VERSCHL.STOPFEN
				TAPPO	TAPON

Electrical Plug
 Prise Electrique
 Elektrischer Stecker
 Presaelettricità
 Tomacorriente

30-120

5-BA64-012-B

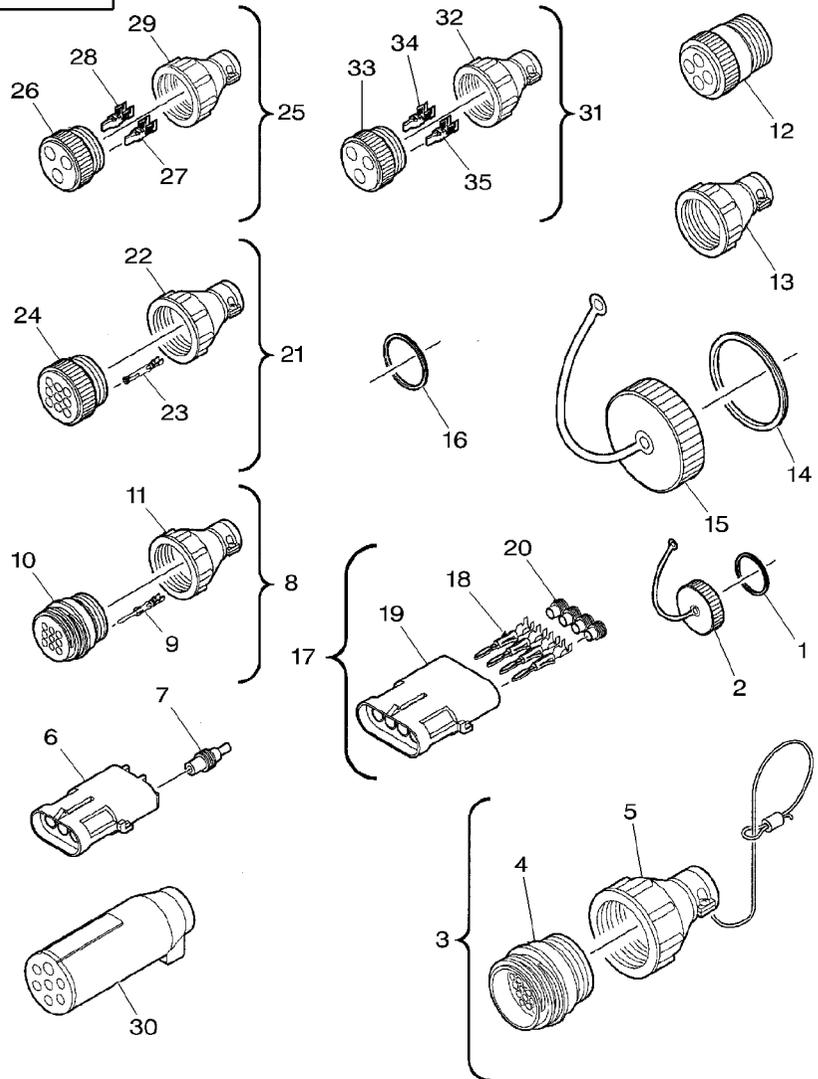

27	700709706	25	3	CONTACT	RUPTEUR	KONTAKT
28	700710620	25	3	CONTACT	CONTATTO	CONTACTO
29	700708756	25	3	CONTACT	RUPTEUR	KONTAKT
30	700706646		1	CLAMP	CONTATTO	CONTACTO
31	1713999		1	PLUG 7 PIN SUP	COLLIER	HALTESCHELLE
32	700708756	31	1	PLUG 7 PIN SUP	FASCETTA	ABRAZADERA
33	700710659	31	1	PLUG 7 PIN SUP	PRISE MALE 7 BR	STECKER 7P ENTST
34	700719297	31	1	PLUG 7 PIN SUP	SPINA DA 7	TOMA 7 ESPIG SUP
35	72514689	31	1	PLUG 7 PIN SUP	JEU REPARATION	REPARATURSATZ
			1	KIT, REPAIR	KIT RIPARAZIONE	JUEGO REPARACION
			1	CLAMP	COLLIER	HALTESCHELLE
			1	ELECTRICAL PLUG	FASCETTA	ABRAZADERA
			3	CONTACT	PRISE ELECT MALE	STECKER
			3	CONTACT	PRESAELETRICI M	TOMACORRIENTE M
			3	CONTACT	RUPTEUR	KONTAKT
			3	CONTACT	CONTATTO	CONTACTO
			3	CONTACT	RUPTEUR	KONTAKT
			3	CONTACT	CONTATTO	CONTACTO

Electrical Plug
Prise Electrique
Elektrischer Stecker
Presaelettricità
Tomacorriente

30-125

5-BA64-016-C

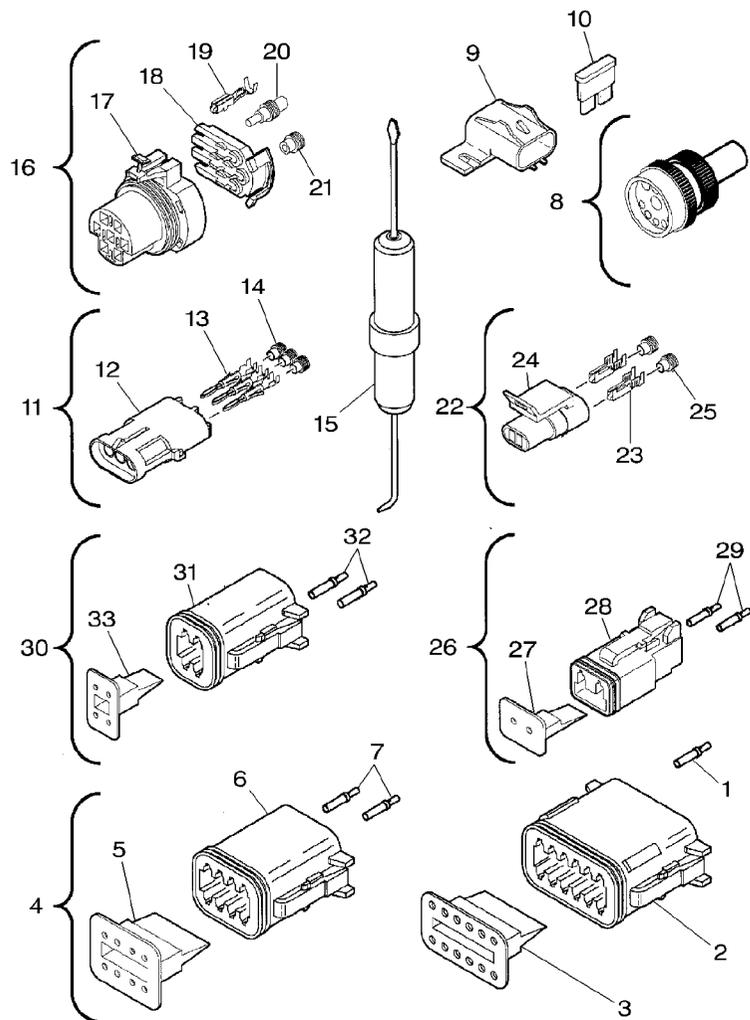

1	700719870	(16-18) FEMALE	12	CONNECTOR	BORNE	DOPPELNIPPEL
2	700719863			HOUSING	MORSETTO	CONECTOR
3	700719868		1	CLIP	CARTER	GEHAEUSE
4	700720802	(8 PIN)	1	KIT, REPAIR	CARCASSA	ALOJAMIENTO
5	700720764	4	1	CLIP	CLIP	SHELLE
6	700720762	4	1	HOUSING	FERMAGLIO	CLIP
7	N858482	4 (14-16) FEMALE	1	KIT, REPAIR	JEU REPARATION	REPARATURSATZ
7	700719870	4 (16-18) FEMALE	1	CLIP	KIT RIPARAZIONE	JUEGO REPARACION
8	N858734	(9 WAY)	1	CLIP	CLIP	SHELLE
9	700720586		1	HOUSING	FERMAGLIO	CLIP
10	3387318M1	5 Amp	1	HOUSING	CARTER	GEHAEUSE
10	1695966M1	15 Amp	1	CONNECTOR	CARCASSA	ALOJAMIENTO
11	700718599	(3 PIN)	8	CONNECTOR	BORNE	DOPPELNIPPEL
12	700706413	11 (3 PIN)	8	CONNECTOR	MORSETTO	CONECTOR
13	700706401	11 (18-20 GAUGE)	1	CONNECTOR	BORNE	DOPPELNIPPEL
14	700706400	11 (18-20 GAUGE)	1	CONNECTOR	MORSETTO	CONECTOR
15	700719871		1	CONNECTOR	BORNE	DOPPELNIPPEL
16	N858736	(12 WAY)	1	CONNECTOR	MORSETTO	CONECTOR
17	N858742	16	1	CONNECTOR	BORNE	DOPPELNIPPEL
18	N858747	16	1	CONNECTOR	MORSETTO	CONECTOR
19	N857482	16 (12/14 GAUGE)	1	CONNECTOR	TERMINAL.	TERMINAL
20	N858743	16 (16-18) FEMALE	3	CONNECTOR	TERMINALE	TERMINAL
21	N858677	16	3	CONNECTOR	MANCHON	TERMINAL
22	700720807		1	CONNECTOR	MANICOTTO	MANCHA
23	72514694	22	4	CONNECTOR	BORNE	DOPPELNIPPEL
24	72514693	22 (2 PIN)	6	CONNECTOR	MORSETTO	CONECTOR
			6	CONNECTOR	BOUCHON	VERSCHL.STOPFEN
			1	CONNECTOR	TAPPO	TAPON
			1	CONNECTOR	JEU REPARATION	REPARATURSATZ
			2	CONNECTOR	KIT RIPARAZIONE	JUEGO REPARACION
			2	CONNECTOR	COSSE	MUFFE
			1	CONNECTOR	BUSSOLA	DEDAL
			1	CONNECTOR	BORNE	DOPPELNIPPEL
				CONNECTOR	MORSETTO	CONECTOR

Electrical Plug
 Prise Electrique
 Elektrischer Stecker
 Presaelettricita
 Tomacorriente

30-125

5-BA64-016-C

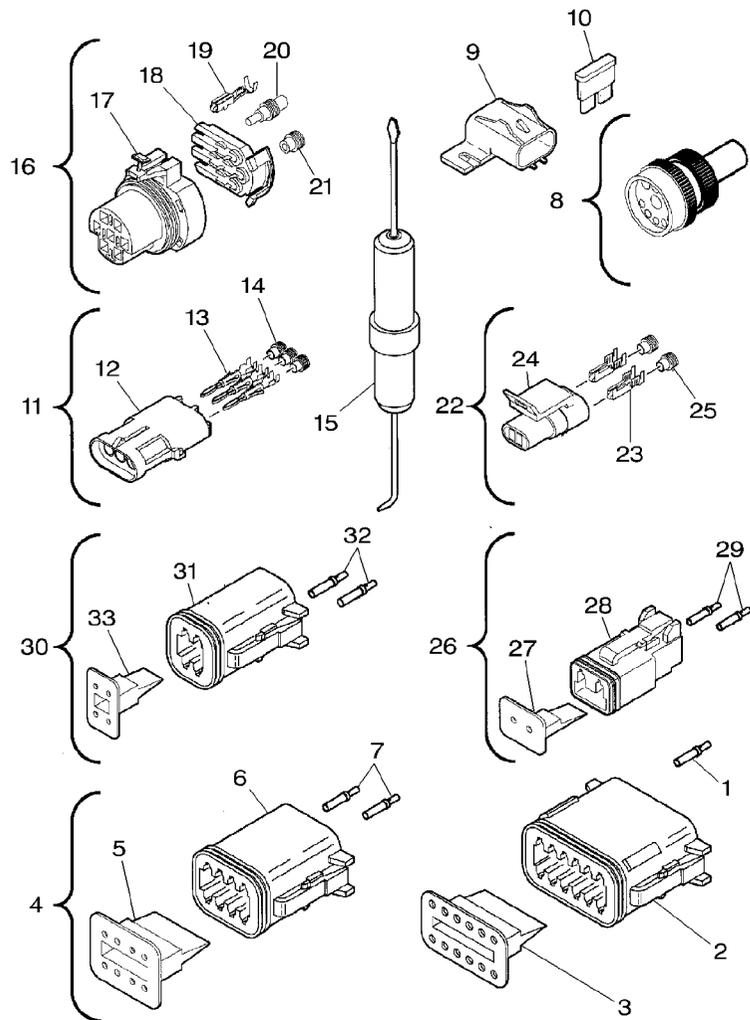

25	N857459	22	2	SEAL	JOINT ETANCHEITE	DICHTRING
26	700720800	(2 PIN)	1	KIT, REPAIR	ANELLO RACCORD	ARENDELA D'JUNTA
27	700720654	26	1	CLIP	JEU REPARATION	REPARATURSATZ
28	700720655	26	1	HOUSING	KIT RIPARAZIONE	JUEGO REPARACION
29	700719870	26 (16-18) FEMALE	2	CONNECTOR	CLIP	SCHELLE
29	N858482	26 (14-16) FEMALE	2	CONNECTOR	FERMAGLIO	CLIP
30	700720801	(4 PIN)	1	KIT, REPAIR	CARTER	GEHAUSE
31	700720765	30	1	HOUSING	CARCASSA	ALOJAMIENTO
32	700719870	30 (16-18) FEMALE	4	CONNECTOR	BORNE	DOPPELNIPPEL
32	N858482	30 (14-16) FEMALE	4	CONNECTOR	MORSETTO	CONECTOR
33	700720766	30	1	CLIP	BORNE	DOPPELNIPPEL
					MORSETTO	CONECTOR
					JEU REPARATION	REPARATURSATZ
					KIT RIPARAZIONE	JUEGO REPARACION
					CARTER	GEHAUSE
					CARCASSA	ALOJAMIENTO
					BORNE	DOPPELNIPPEL
					MORSETTO	CONECTOR
					BORNE	DOPPELNIPPEL
					MORSETTO	CONECTOR
					CLIP	SCHELLE
					FERMAGLIO	CLIP

--	--	--

40

Transmission
Transmission
Getriebe
Transmissione
Transmission

40-5

Feeder - Up To 190lb-50146
Ameneur - Jusqu' Au 190lb-50146
Zubringer - Bis 190lb-50146
Infaldatore - Fino All 190lb-50146
Embocador - Hasta 190lb-50146

5-BA01-012-B

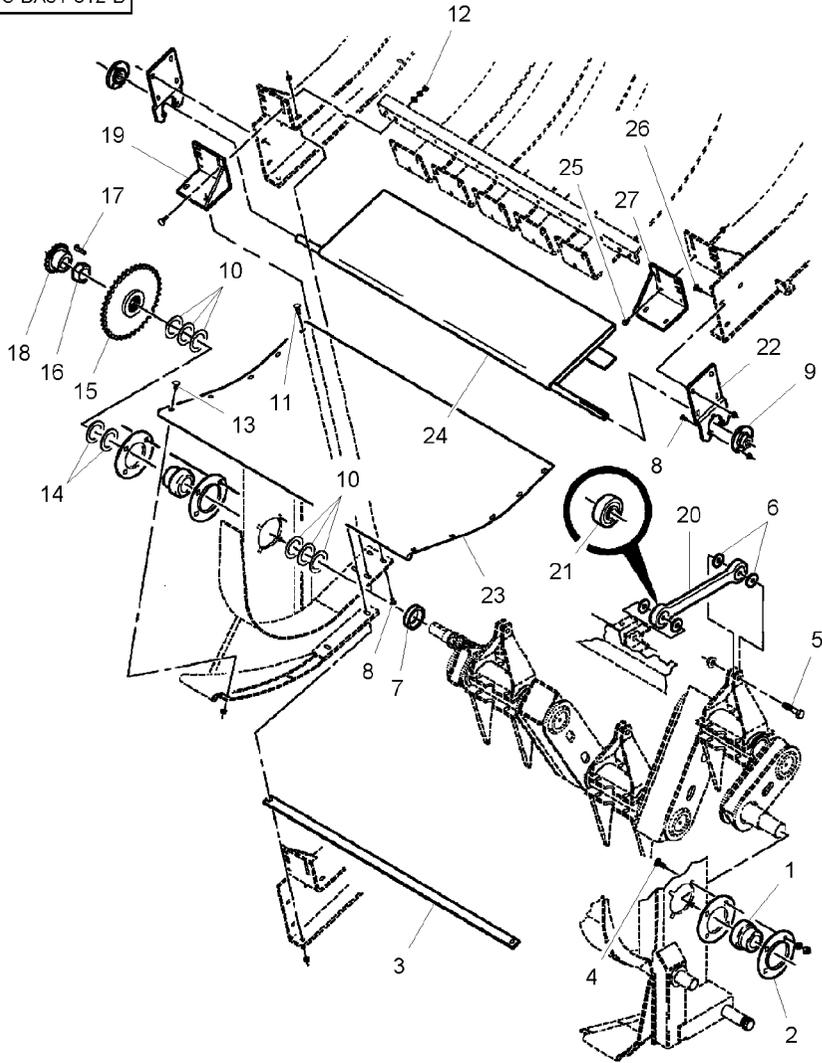

1★712158		2 BEARING	COUSSINET	LAGER
2★714360		4 FLANGE	CUSCINETTO	COJINETE
3★6525455		1 SHANK	FLASQUE	FLANSCH
4★68619	1/2"-13 X 1-1/4	8 BOLT	FLANGIA	PLETINA
4★Y705046	1/2"	8 LOCK WASHER	ANGLE	SCHAFT
4★704031	1/2"-13	8 NUT	FUSO	MANGO
5★70921360	5/8"-11 X 2-1/4	6 CAPSCREW	BOULON	MASCH.SCHRAUBE
5★7774482	5/8"-11	6 LOCKNUT	BULLONE	ESPIGA/BULON
6★700124038		12 BUSH	RONDELLE FREIN	FEDERRING
7★700113666P		1 SPACER	ROSETTA DENTELL.	ARANDELA GROWER
8★7700461	5/16"-18 X 3/4	14 BOLT	ECROU	MUTTER
8★70931277	5/16"-18	14 NUT	DADO	TUERCA
9★50393		2 BEARING	VIS BOUCHON	HUTSCHRAUBE
10★Y52548	2" X 14	6 WASHER	TAPPO A VITE	TORNILLO TAPON
11★70923220	3/8"-16 X 1-1/4	2 BOLT	ECROU BLOCCAGE	SICHERUNGSMUTTER
11★704247	3/8"-16	2 NUT	AUTOBLOCCANTE	CONTRATUERCA
12★70923220	3/8"-16 X 1-1/4	2 BOLT	BAGUE	BUCHSE
12★Y705533	3/8"	2 WASHER	BOCCOLA	CASQUILLO
12★70916965	3/8"	2 LOCK WASHER	ENTRETOISE	ABSTANDSTUECK
12★70916950	3/8"-16	2 NUT	DISTANZIALE	DISCO ESPACIADOR
13★70922784	3/8"-16 X 3/4	8 BOLT	BOULON	MASCH.SCHRAUBE
13★704247	3/8"-16	8 NUT	BULLONE	ESPIGA/BULON
14★740407	2" X 10	2 BUSH	ECROU	MUTTER
15★700113663	38	1 SPROCKET	DADO	TUERCA
16★700113661	1"-5/8-12	1 NUT	BOULON	MASCH.SCHRAUBE
17★61572	3/8" X 1-3/4	1 KEY	BULLONE	ESPIGA/BULON
			RONDELLE	UNTERLEGSCHIEBE
			RONDELLA	ARANDELA
			BOULON	MASCH.SCHRAUBE
			BULLONE	ESPIGA/BULON
			ECROU	MUTTER
			DADO	TUERCA
			BOULON	MASCH.SCHRAUBE
			BULLONE	ESPIGA/BULON
			RONDELLE	UNTERLEGSCHIEBE
			RONDELLA	ARANDELA
			RONDELLE FREIN	FEDERRING
			ROSETTA DENTELL.	ARANDELA GROWER
			ECROU	MUTTER
			DADO	TUERCA
			BOULON	MASCH.SCHRAUBE
			BULLONE	ESPIGA/BULON
			ECROU	MUTTER
			DADO	TUERCA
			BAGUE	BUCHSE
			BOCCOLA	CASQUILLO
			BARBOTIN	KETTENRAD
			RUOTA MOTRICE	RUEDA DE CADENA
			ECROU	MUTTER
			DADO	TUERCA
			CLAVETTE	PASSKEIL
			CHIAVETTA	CLAVE

Transmission
 Transmission
 Getriebe
 Transmissione
 Transmission

40-5

Feeder - Up To 190lb-50146
 Ameneur - Jusqu' Au 190lb-50146
 Zubringer - Bis 190lb-50146
 Infaldatore - Fino All 190lb-50146
 Embocador - Hasta 190lb-50146

5-BA01-012-B

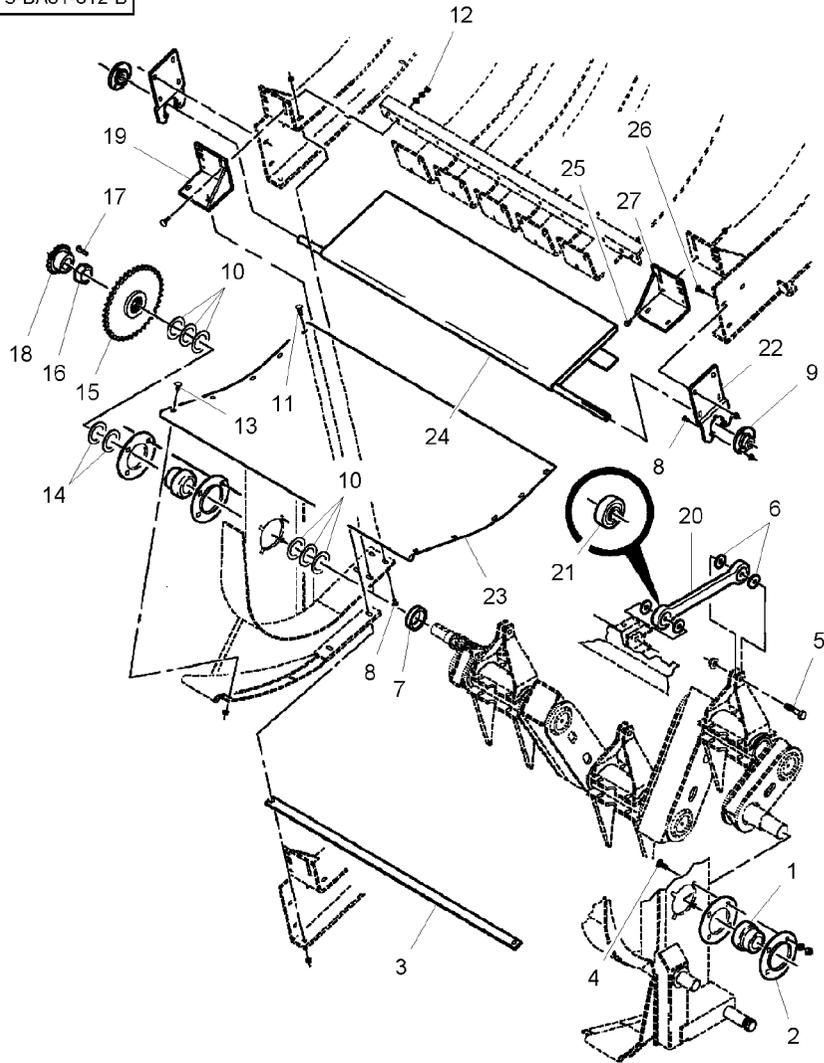

18★700706097	15	1 SPROCKET	BARBOTIN	KETTENRAD
19★700112826P	▶	1 ANGLE.	RUOTA MOTRICE	RUEDA DE CADENA
20★700124036P		3 LINK	EQUERRE	WINKEL
21★1109055	20	2 BEARING	ANGOLO	ANGULO
22★700112815P		2 SUPPORT	MAILLON	GLIED
23★700112812		1 PANEL	MAGLIA	ENLACE
24★6525471P		1 PANEL	COUSSINET	LAGER
25★Y703132	5/16"-18 X 3/4	4 SCREW	CUSCINETTO	COJINETE
26★70931277	5/16"-18	4 NUT	SUPPORT	LAGERUNG
27★700112825P	▶	1 ANGLE.	SUPPORTO	DISPOS.DE SOSTEN
			PANNEAU	VERKL.BLECH
			PANNELLO	PANELAJE
			PANNEAU	VERKL.BLECH
			PANNELLO	PANELAJE
			VIS	SCHRAUBE
			VITE	TORNILLO
			ECROU	MUTTER
			DADO	TUERCA
			BOULON	MASCH.SCHRAUBE
			BULLONE	ESPIGA/BULON
			ECROU	MUTTER
			DADO	TUERCA
			EQUERRE	WINKEL
			ANGOLO	ANGULO

Transmission
 Transmission
 Getriebe
 Transmissione
 Transmission

40-10

Feeder - From 190lb-50147 - Up To H.N 91100
 Ameneur - A Partir Du 190lb-50147 - Jusqu'au H.N 91100
 Zubringer - Ab 190lb-50147 - Bis Den H.N 91100
 Infaldatore - Dalla 190lb-50147 - Fino Alla H.N 91100
 Embocador - A Partir Del 190lb-50147 - Hasta H.N 91100

5-BA01-034-B

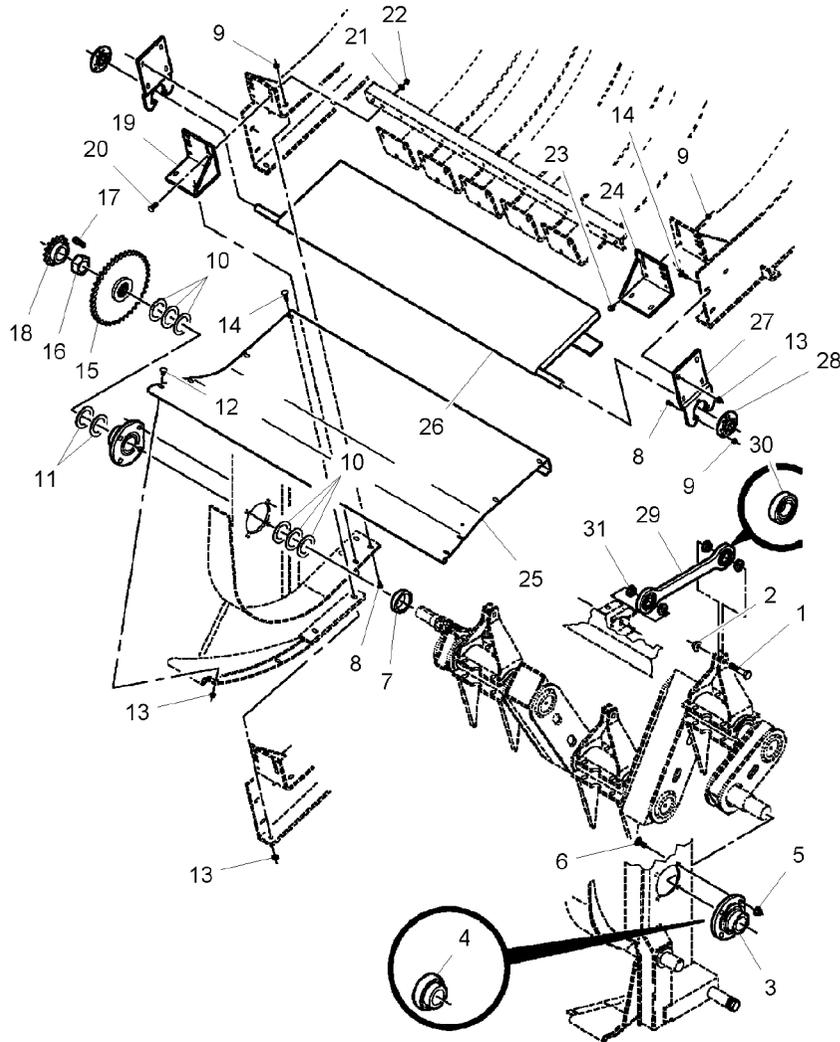

1	★70921360	5/8"-11 X 2-1/4	6	CAPSCREW	VIS BOUCHON	HUTSCHRAUBE
2	7774482	5/8"-11	6	LOCKNUT	TAPPO A VITE	TORNILLO TAPON
3	700109753P		4	BEARING FLANGE	ECROU BLOCAGE	SICHERUNGSMUTTER
4	712158	3		AUTOBLOCCANTE	FLASQUE ROULT	CONTRATUERCA
5	700714586	1/2"-13	2	BEARING	BEARING FLANGE	LAGERFLANSCH
6	★70926838	1/2"-13 X 1-1/2		COUSSINET	BEARING FLANGE	BEARING FLANGE
7	700113666P			CUSCINETTO	LAGER	LAGER
8	★7700461	5/16"-18 X 3/4	8	NUT	COJINETE	COJINETE
9	70931277	5/16"-18		ECROU	MUTTER	MUTTER
10	Y52548	2" X 14		DADO	TUERCA	TUERCA
11	740407	2" X 10	8	BOLT	BOULON	MASCH.SCHRAUBE
12	70922784	3/8"-16 X 3/4		BULLONE	BULLONE	ESPIGA/BULON
13	704247	3/8"-16	1	SPACER	ENTRETROISE	ABSTANDSTUECK
14	70922786	3/8"-16 X 1	14	BOLT	DISTANZIALE	DISCO ESPACIADOR
15	700113663	➔ HK 91220	18	NUT	BOULON	MASCH.SCHRAUBE
15	700138873P	➔ HK 91221		DADO	BULLONE	ESPIGA/BULON
16	700113661	➔ 38	6	WASHER	ECROU	MUTTER
17	61572	➔ 31		RONDELLE	DADO	TUERCA
18	700706097	➔ HK 91220	8	BOLT	BOULON	MASCH.SCHRAUBE
18	700726187	➔ HK 91221	1	SPROCKET	BULLONE	ESPIGA/BULON
19	700112826P	➔ 15	16	NUT	BARBOTIN	KETTENRAD
20	★70923220	➔ 14		DADO	RUOTA MOTRICE	RUEDA DE CADENA
21	Y705533	▶	1	SPROCKET	BARBOTIN	KETTENRAD
22	700711238		1	NUT	RUOTA MOTRICE	RUEDA DE CADENA
23	Y703132		1	KEY	ECROU	MUTTER
24	700112825P	▶	1	ANGLE.	DADO	TUERCA
			1	KEY	CLAVETTE	PASSKEIL
			1	SPROCKET	CHIAVETTA	CLAVE
			1	SPROCKET	BARBOTIN	KETTENRAD
			1	SPROCKET	RUOTA MOTRICE	RUEDA DE CADENA
			1	SPROCKET	BARBOTIN	KETTENRAD
			1	SPROCKET	RUOTA MOTRICE	RUEDA DE CADENA
			1	ANGLE.	EQUERRE	WINKEL
			2	BOLT	ANGOLO	ANGULO
			2	WASHER	BOULON	MASCH.SCHRAUBE
			2	LOCKNUT	BULLONE	ESPIGA/BULON
			4	SCREW	RONDELLE	UNTERLEGSCHIEBE
			4	SCREW	RONDELLE	ARANDELA
			1	ANGLE.	ECROU BLOCAGE	SICHERUNGSMUTTER
			1	ANGLE.	AUTOBLOCCANTE	CONTRATUERCA
			1	ANGLE.	VIS	SCHRAUBE
			1	ANGLE.	VITE	TORNILLO
			1	ANGLE.	EQUERRE	WINKEL
			1	ANGLE.	ANGOLO	ANGULO

Transmission
 Transmission
 Getriebe
 Transmissione
 Transmission

40-10

Feeder - From 190lb-50147 - Up To H.N 91100
 Ameneur - A Partir Du 190lb-50147 - Jusqu'au H.N 91100
 Zubringer - Ab 190lb-50147 - Bis Den H.N 91100
 Infaldatore - Dalla 190lb-50147 - Fino Alla H.N 91100
 Embocador - A Partir Del 190lb-50147 - Hasta H.N 91100

5-BA01-034-B

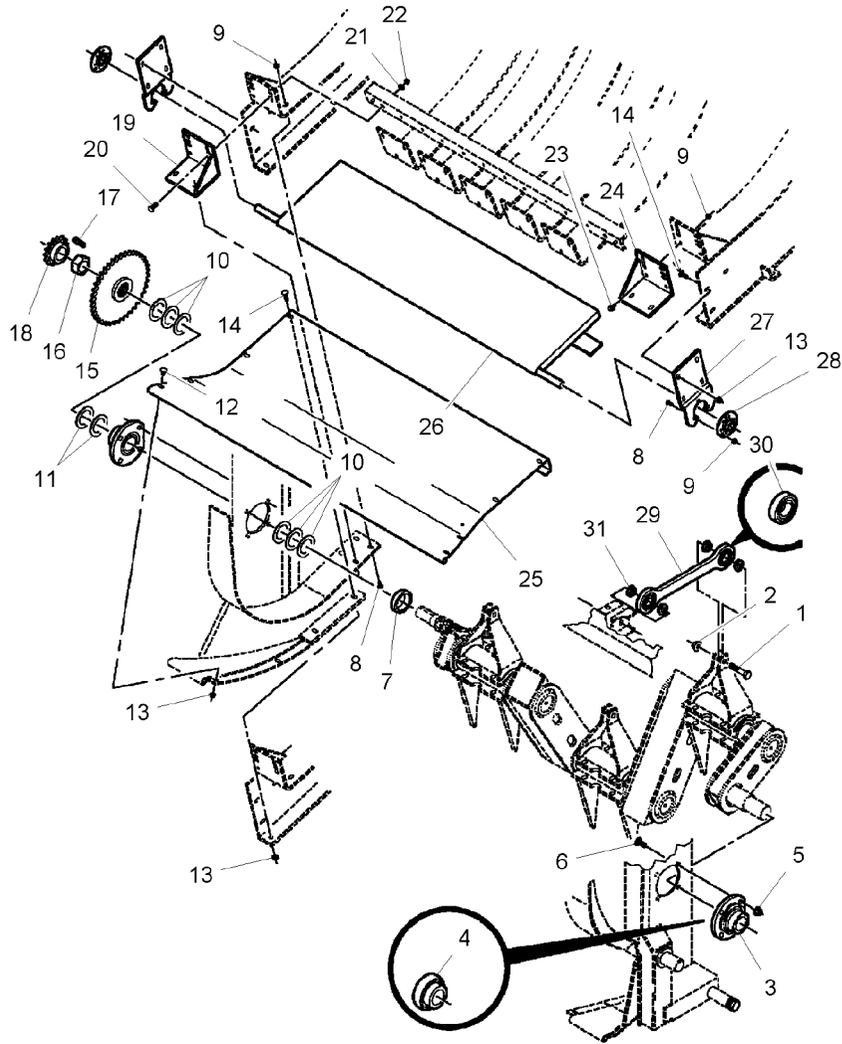

25	700134962P	1	PANEL	PANNEAU	VERKL.BLECH
26	6525471P	1	PANEL	PANNELLO	PANELAJE
27	700112815P	2	SUPPORT	PANNEAU	VERKL.BLECH
28	50393	2	BEARING	PANNELLO	PANELAJE
29	700124036P	3	LINK	SUPPORT	LAGERUNG
30	1109055	6	BEARING	SUPPORTO	DISPOS.DE SOSTEN
31	700124038	12	BUSH	COUSSINET	LAGER
				CUSCINETTO	COJINETE
				MAILLON	GLIED
				MAGLIA	ENLACE
				COUSSINET	LAGER
				CUSCINETTO	COJINETE
				BAGUE	BUCHSE
				BOCCOLA	CASQUILLO

Transmission
Transmission
Getriebe
Transmissione
Transmission

40-15

Feeder - From H.N 91101
Ameneur - A Partir Du H.N 91101
Zubringer - Ab H.N 91101
Infaldatore - Dalla H.N 91101
Embocador - A Partir Del H.N 91101

5-BA01-062-A

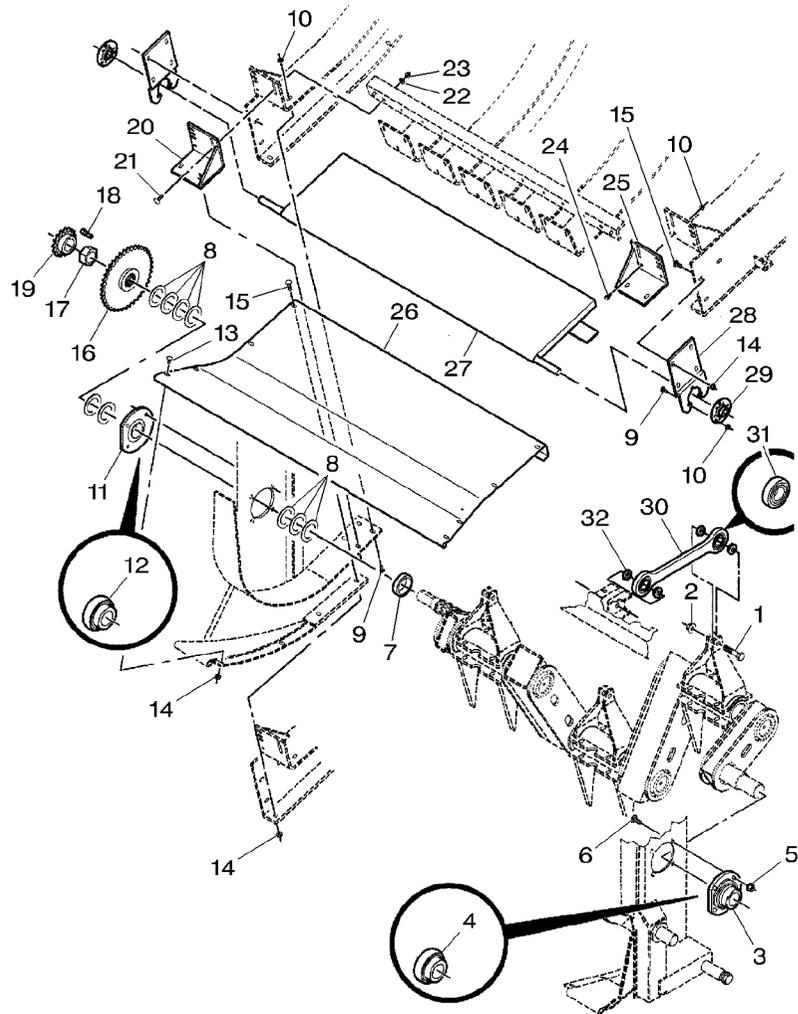

1	70921360	5/8"-11 X 2-1/4	6	CAPSCREW	VIS BOUCHON	HUTSCHRAUBE
2	7774482	5/8"-11	6	LOCKNUT	TAPPO A VITE	TORNILLO TAPON
3	700109753P		1	BEARING FLANGE	ECROU BLOCCAGE	SICHERUNGSMUTTER
4	712158	3	1	BEARING	AUTOBLOCCANTE	CONTRATUERCA
5	700714586	1/2"-13	1	BEARING FLANGE	FLASQUE ROULT	LAGERFLANSCH
6	70926838	1/2"-13 X 1-1/2	1	BEARING	BEARING FLANGE	BEARING FLANGE
7	700137336P		1	BEARING	COUSSINET	LAGER
8	Y852947	2"-1/4 X 14	8	NUT	CUSCINETTO	COJINETE
9	7700461	5/16"-18 X 3/4	8	BOLT	ECROU	MUTTER
10	70931277	5/16"-18	8	BOLT	DADO	TUERCA
11	700716611		8	BOLT	BOULON	MASCH.SCHRAUBE
12	700704263	11	8	BOLT	BULLONE	ESPIGA/BULON
13	70922784	3/8"-16 X 3/4	1	SPACER	BULLONE	ESPIGA/BULON
14	704247	3/8"-16	1	SPACER	ENTRETROISE	ABSTANDSTUECK
15	70922786	3/8"-16 X 1	9	BUSH	DISTANZIALE	DISCO ESPACIADOR
16	700157788P	31	9	BUSH	BAGUE	BUCHSE
17	700715751		14	BOLT	BOCCOLA	CASQUILLO
18	61572	3/8" X 1-3/4	14	BOLT	BOULON	MASCH.SCHRAUBE
19	700726187	14	18	NUT	BULLONE	ESPIGA/BULON
20	700112826P		1	BEARING FLANGE	ECROU	MUTTER
21	70923220	3/8"-16 X 1-1/4	1	BEARING FLANGE	DADO	TUERCA
22	Y705533	3/8"	1	BEARING	BOULON	MASCH.SCHRAUBE
23	700711238	3/8"-16	1	BEARING	BULLONE	ESPIGA/BULON
24	Y703132	5/16"-18 X 3/4	1	BEARING FLANGE	BARBOTIN	KETTENRAD
25	700112825P		1	BEARING	RUOTA MOTRICE	RUEDA DE CADENA
26	700134962P		1	BEARING	ECROU	MUTTER
			1	BEARING FLANGE	DADO	TUERCA
			1	BEARING FLANGE	CLAVETTE	PASSKEIL
			1	BEARING	CHIAVETTA	CLAVE
			1	BEARING	BARBOTIN	KETTENRAD
			1	BEARING	RUOTA MOTRICE	RUEDA DE CADENA
			1	BEARING	EQUERRE	WINKEL
			1	BEARING	ANGOLO	ANGULO
			2	BOLT	BOULON	MASCH.SCHRAUBE
			2	WASHER	BULLONE	ESPIGA/BULON
			2	LOCKNUT	RONDELLE	UNTERLEGSCHIEBE
			4	SCREW	RONDELLE	ARANDELA
			1	ANGLE.	ECROU BLOCCAGE	SICHERUNGSMUTTER
			1	PANEL	AUTOBLOCCANTE	CONTRATUERCA
			1	PANEL	VIS	SCHRAUBE
			1	PANEL	VITE	TORNILLO
			1	PANEL	EQUERRE	WINKEL
			1	PANEL	ANGOLO	ANGULO
			1	PANEL	PANNEAU	VERKL.BLECH
			1	PANEL	PANNELLO	PANELAJE

Transmission
 Transmission
 Getriebe
 Transmisione
 Transmission

40-15

Feeder - From H.N 91101
 Ameneur - A Partir Du H.N 91101
 Zubringer - Ab H.N 91101
 Infaldatore - Dalla H.N 91101
 Embocador - A Partir Del H.N 91101

5-BA01-062-A

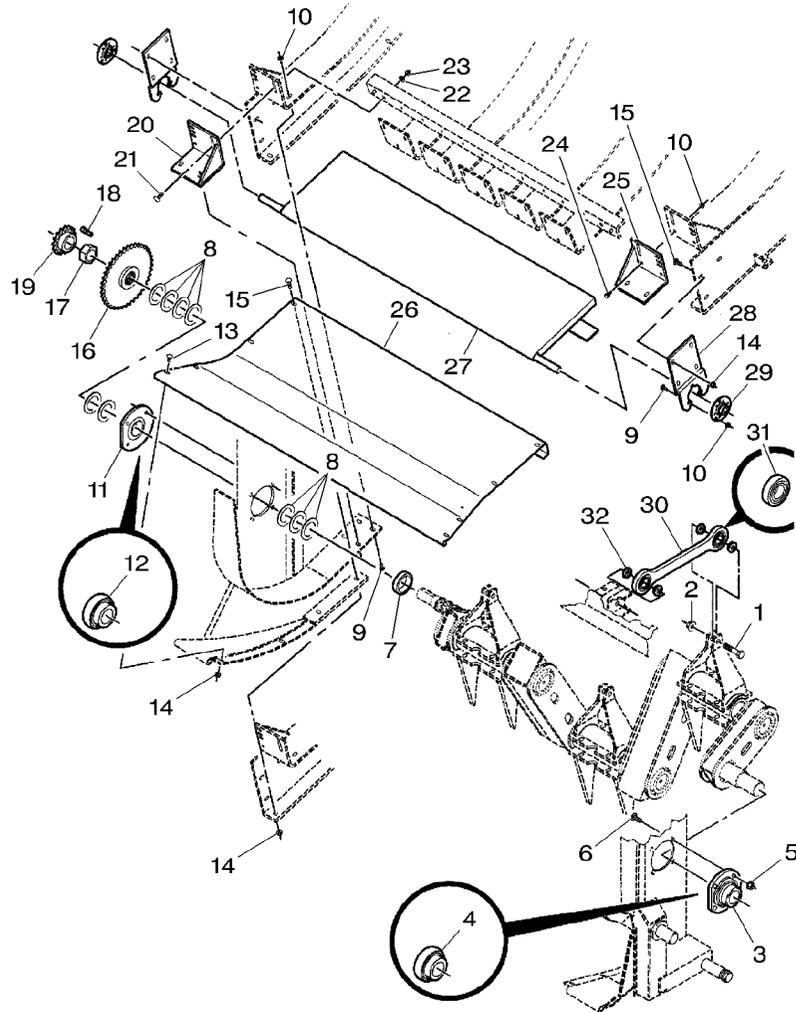

27 6525471P

28 700112815P

29 50393

30 700124036P

31 1109055 30

32 700124038

1 PANEL

2 SUPPORT

2 BEARING

3 LINK

2 BEARING

12 BUSH

PANNEAU
 PANNELLO
 SUPPORTO
 SUPPORTO
 COUSSINET
 CUSCINETTO
 MAILLON
 MAGLIA
 COUSSINET
 CUSCINETTO
 BAGUE
 BOCCOLA

VERKL.BLECH
 PANELAJE
 LAGERUNG
 DISPOS.DE SOSTEN
 LAGER
 COJINETE
 GLIED
 ENLACE
 LAGER
 COJINETE
 BUCHSE
 CASQUILLO

Transmission
 Transmission
 Getriebe
 Transmissions
 Transmisión

40-20

Crankshaft
 Vilebrequin
 Kurbelwelle
 Albero A Gomito
 Ciguenal

5-BA01-011-C

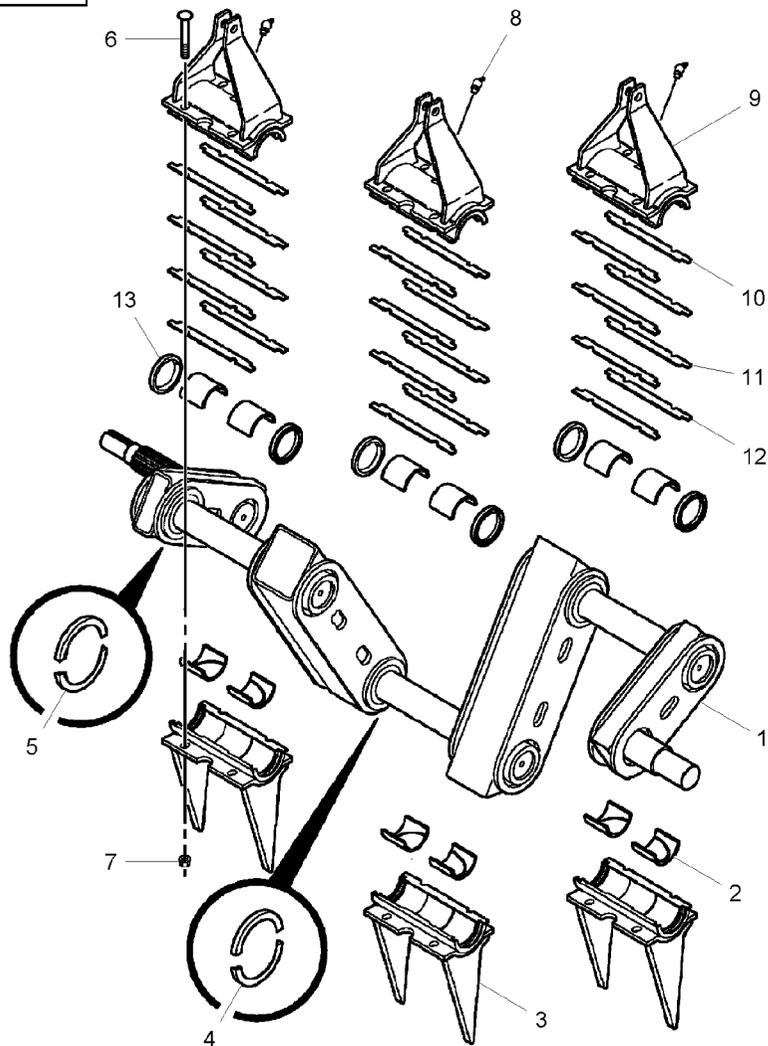

1	700112823	➡ HN 91100	1	CRANK	MANIVELLE	KURBEL
1	★700157785P	➡ HN 91101	1	CRANK	MANOVELLA	MANIVELA
2	700706131		1	CRANK	MANIVELLE	KURBEL
3	700112787P		6	BEARING	MANOVELLA	MANIVELA
4	700122667	1 ∅ INT 76,2 MM	3	FINGER	COUSSINET	LAGER
5	700122669	1 ∅ INT 82,5 MM	3	FINGER	CUSCINETTO	COJINETE
6	364982X1	1/2"-13 X 3-3/4	1	KIT	DOIGT	FINGER
7	Y704742	1/2"-13	1	KIT	DITO	DEDO
8	19575X	[A] 1/8" X 45°	1	KIT	JEU	SATZ
9	700112817P		1	KIT	KIT	JUEGO
10	700706850	∅ 0.51/.020	1	KIT	JEU	SATZ
11	700706133	∅ 0.25/.010	1	KIT	KIT	JUEGO
12	700706134	∅ 0.13/.005	12	BOLT	BOULON	MASCH.SCHRAUBE
13	700706096		12	LOCKNUT	BULLONE	ESPIGA/BULON
			12	LOCKNUT	ECROU BLOCAGE	SICHERUNGSMUTTER
			3	GREASE NIPPLE	AUTOBLOCCANTE	CONTRATUERCA
			3	ARM	GRAISSEUR DROIT	FETT-NIPPEL
			3	ARM	INGRASSAT.	ENGRASADOR
			3	ARM	BRAS	ARM
			12	SHIM	BRACCIO	BRAZO
			6	SHIM	CALE REGLAGE	EINSTELLBLECH
			6	SHIM	SPESSORE	CALCE
			6	SHIM	CALE REGLAGE	EINSTELLBLECH
			6	SHIM	SPESSORE	CALCE
			6	SHIM	CALE REGLAGE	EINSTELLBLECH
			6	SHIM	SPESSORE	CALCE
			6	SEAL	JOINT ETANCHEITE	DICHTRING
			6	SEAL	ANELLO RACCORD	ARENDELA D'JUNTA

[A] USED ONLY ON UNIT WITHOUT CENTRALIZED LUBRICATION SYSTEM
 UTILISE A DEFAUT DE LUBRIFICATION CENTRALISE
 VERWENDEN WENN KEINE ZENTRALSCHMIERUNG
 UTILIZZARE SE NON LUBRIFICAZIONE CENTRALE
 USAR SI NO ENGRASE CENTRAL

Finger
Ameneurs
Zubringer
Infaldatore
Embocador

40-25

Left Side
Cote Gauche
Linke Seite
Lato Sinistro
Lado Izquierdo

5-BA29-003-C

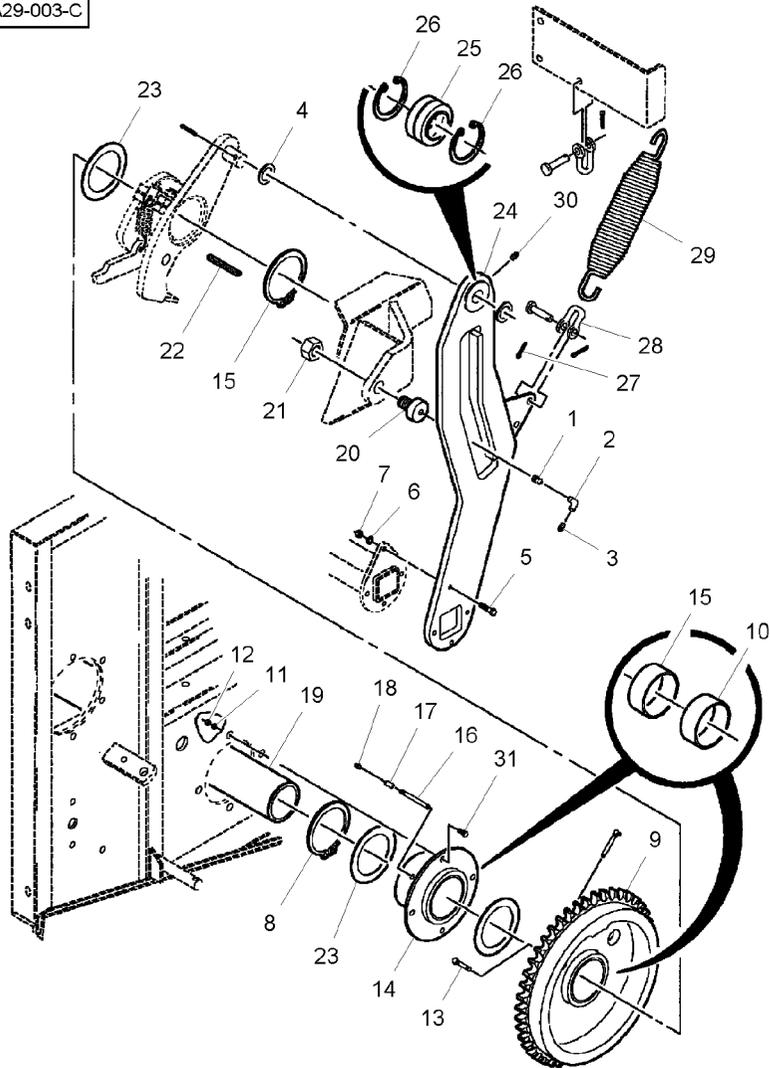

1	70930680	3/16"	1	PIN	GOUILLE	BOLZEN
2	700706279		1	COUPLER	PERNO	PASADOR
3	70923219	1/4"-28	1	GREASER	ACCOUPLMENT	KUPPLUNGSTUECK
4	Y52324	1"-1/4 X 10	1	ACCOPIATORE	ACCOPIADORE	ACOPLADOR
5	★70921969	3/8"-16 X 1-1/2	1	GRAISSEUR	INGRASSATORE	FETTNIPEL
6	★70916965	3/8"	2	INGRASSATORE	BAGUE	ENGRASADOR
7	★70916950	3/8"-16	4	BOCCOLA	BOCCOLA	BUCHSE
8	7852148		4	CASQUILLO	VIS BOUCHON	CASQUILLO
9	700112880P		4	HUTSCHRAUBE	TAPPO A VITE	HUTSCHRAUBE
10	700112892	9	4	TORNILLO TAPON	RONDELLE FREIN	FEDERRING
11	★Y705046	1/2"	4	ARANDELA GROWER	ROSETTA DENTELL.	ARANDELA GROWER
12	★704031	1/2"-13	4	MUTTER	ECROU	MUTTER
13	77388	1/8"-27 X 90°	2	TUERCA	DADO	TUERCA
14	700112876P	👁 40-35 No 14	2	RING	ANNEAU	RING
15	700112892	14	2	ARO	ANELLO	ARO
16	8746042	[A]	1	KETTENRAD	BARBOTIN	KETTENRAD
17	70915955	[A]	2	RUEDA DE CADENA	RUOTA MOTRICE	RUEDA DE CADENA
18	70914465	[A]	2	LAGER	COUSSINET	LAGER
19	700112881	1/8" X 90°	4	COJINETE	CUSCINETTO	COJINETE
20	7713837	1/8"-27	4	FEDERRING	RONDELLE FREIN	FEDERRING
21	★70929602	1"-1/8-12	4	ARANDELA GROWER	ROSETTA DENTELL.	ARANDELA GROWER
22	6201404	5/16X5/16X3-3/4	4	MUTTER	ECROU	MUTTER
23	700112885P		2	TUERCA	DADO	TUERCA
24	700112842	➡ 190LB-50100 👁 40-35 No 14 ➡ 190LB-50101	2	ANSCHL.VERSCHRBBG	MONTAGE	ANSCHL.VERSCHRBBG
25	712810	24	1	ACCESORIO.	RACCORDO.	ACCESORIO.
			1	LAGERUNG	SUPPORT	LAGERUNG
			2	DISPOS.DE SOSTEN	SUPPORTO	DISPOS.DE SOSTEN
			2	LAGER	COUSSINET	LAGER
			1	COJINETE	CUSCINETTO	COJINETE
			1	NIPPEL	GRAISSEUR COUDE	NIPPEL
			1	NIPLE	NIPPLO	NIPLE
			1	WINKELSTUECK	COUDE	WINKELSTUECK
			1	CODO	GOMITO	CODO
			1	FETT-NIPPEL	GRAISSEUR DROIT	FETT-NIPPEL
			1	ENGRASADOR	INGRASSAT.	ENGRASADOR
			1	WELLE	ARBRE	WELLE
			1	ARBOL	ALBERO	ARBOL
			1	LAGER	COUSSINET	LAGER
			1	COJINETE	CUSCINETTO	COJINETE
			1	MUTTER	ECROU	MUTTER
			1	TUERCA	DADO	TUERCA
			3	PASSKEIL	CLAVETTE	PASSKEIL
			1	CLAVE	CHIAVETTA	CLAVE
			1	ARM	BRAS	ARM
			1	BRAS	BRACCIO	BRAS
			1	BRACCIO	BRAS	BRACCIO
			1	BRAS	BRACCIO	BRAS
			1	BRAZO	BAGUE	BRAZO
			1	BUCHSE	BOCCOLA	BUCHSE
			1	CASQUILLO	BOCCOLA	CASQUILLO

Finger
Ameneurs
Zubringer
Infaldatore
Embocador

40-25

Left Side
Cote Gauche
Linke Seite
Lato Sinistro
Lado Izquierdo

5-BA29-003-C

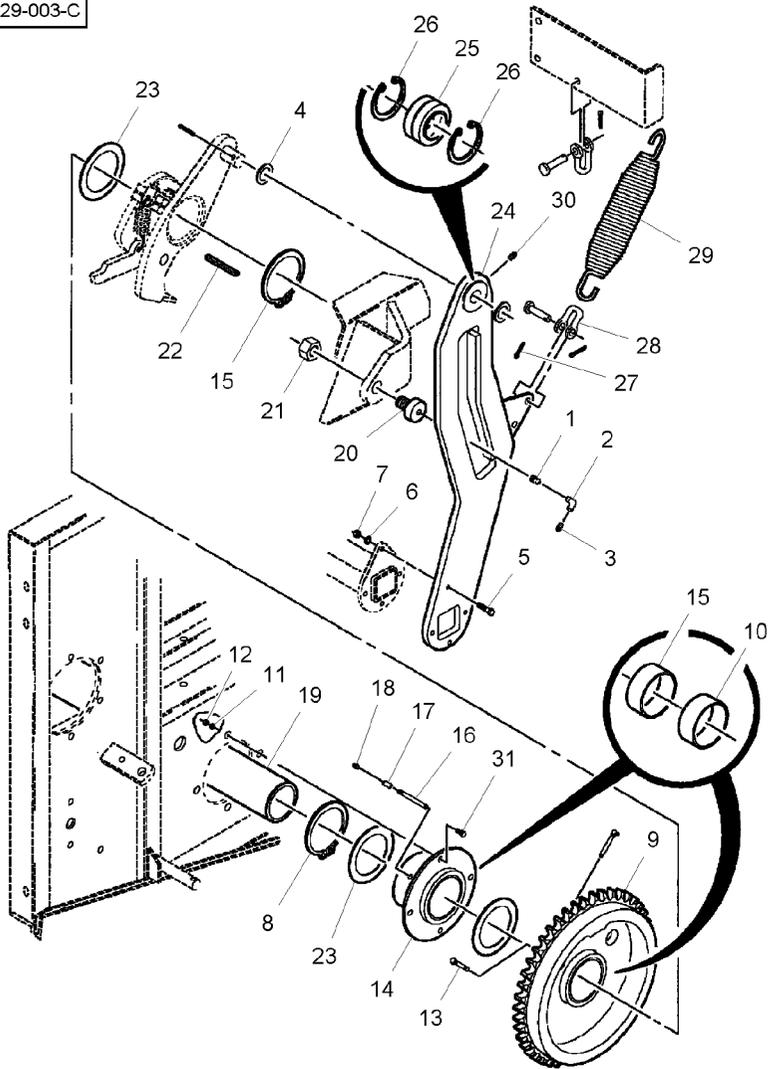

26	70927700	24	2	RING	ANNEAU	RING
27	62307	1/4" X 2	1	PIN	ANELLO	ARO
28	Y766113		1	CLEVIS	GOUPILLE	BOLZEN
29	7758758		2	CLEVIS	PERNO	PASADOR
30	70915276	1/8"-27 X 90°	1	SPRING	CHAPE	GABELSTUECK
31	70921176	1/2"-13 X 1-1/4	1	NIPPLE	GANCIO D'ATTACCO	GANCHO SEGUR.
			1	SPRING	RESSORT	FEDER
			1	NIPPLE	MOLLA	RESORTE
			1	NIPPLE	GRAISSEUR COUDE	NIPPEL
			4	CAPSCREW	NIPPLO	NIPLE
					VIS BOUCHON	HUTSCHRAUBE
					TAPPO A VITE	TORNILLO TAPON

[A] USED ONLY ON UNIT WITHOUT CENTRALIZED LUBRICATION SYSTEM
 UTILISE A DEFAUT DE LUBRIFICATION CENTRALISE
 VERWENDEN WENN KEINE ZENTRALSCHMIERUNG
 UTIZZARE SE NON LUBRIFICAZIONE CENTRALE
 USAR SI NO ENGRASE CENTRAL

Hay Check
Reteneur Escamotable
Pressgut-Rueckhalter
Controllo Fieno
Control

40-30

5-BA30-003-D

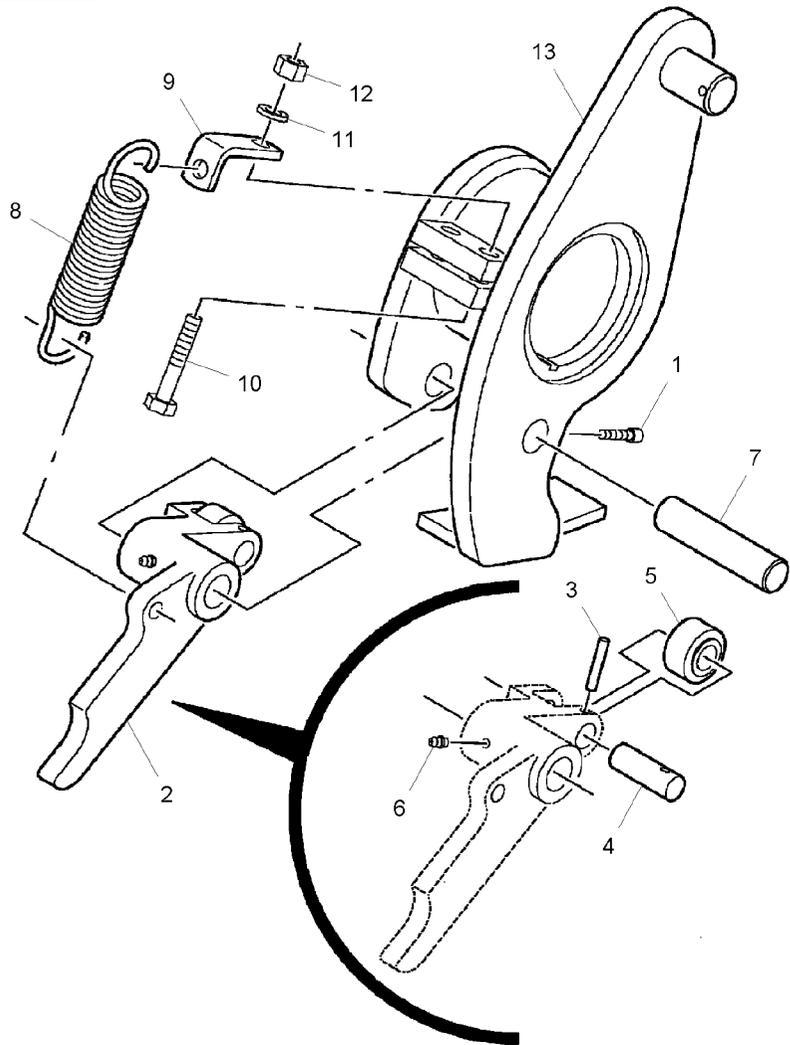

1	Y708230	5/16"-18 X 3/4	1	SETSCREW	VIS DE BLOCAGE	STELLSCHRAUBE
2	700124058P	➡ 190LB-50101	1	ARM	INSIEME VITI	SET SCREW
3	70916171	2 1/4" X 1-1/2	1	PIN	BRAS	ARM
4	700112857	2	1	SHAFT	BRACCIO	BRAZO
5	700112856P	2	1	ROLLER	GOUPILLE	BOLZEN
6	70923219	2 1/4"-28	1	GREASER	PERNO	PASADOR
7	700112858		1	SHAFT	ARBRE	WELLE
8	758268		1	TENSION SPRING	ALBERO	ARBOL
9	700112859P		1	SUPPORT	GALET	ROLLE
10	70921211	1/2"-13 X 2-1/2	2	CAPSCREW	RULLO	RODILLO
11	Y705046	1/2"	2	LOCK WASHER	GRAISSEUR	FETTNIPPEL
12	704031	1/2"-13	2	NUT	INGRASSATORE	ENGRASADOR
13	700112887P	◀	1	ARM	ARBRE	WELLE
			1	ARM	ALBERO	ARBOL
			1	TENSION SPRING	RESSORT TRACTION	ZUGFEDER
			1	SUPPORT	MOLLA TENDITRICE	MUELLE TENSION
			2	CAPSCREW	SUPPORT	LAGERUNG
			2	LOCK WASHER	SUPPORTO	DISPOS.DE SOSTEN
			2	NUT	VIS BOUCHON	HUTSCHRAUBE
			1	ARM	TAPPO A VITE	TORNILLO TAPON
			2	LOCK WASHER	RONDELLE FREIN	FEDERRING
			2	NUT	ROSETTA DENTELL.	ARANDELA GROWER
			2	NUT	ECROU	MUTTER
			1	ARM	DADO	TUERCA
			1	ARM	BRAS	ARM
			1	ARM	BRACCIO	BRAZO

Finger
Ameneurs
Zubringer
Infaldatore
Embocador

40-35

Right Side
Cote Droit
Rechte Seite
Lato Destro
Lado Derecho

5-BA29-004-C

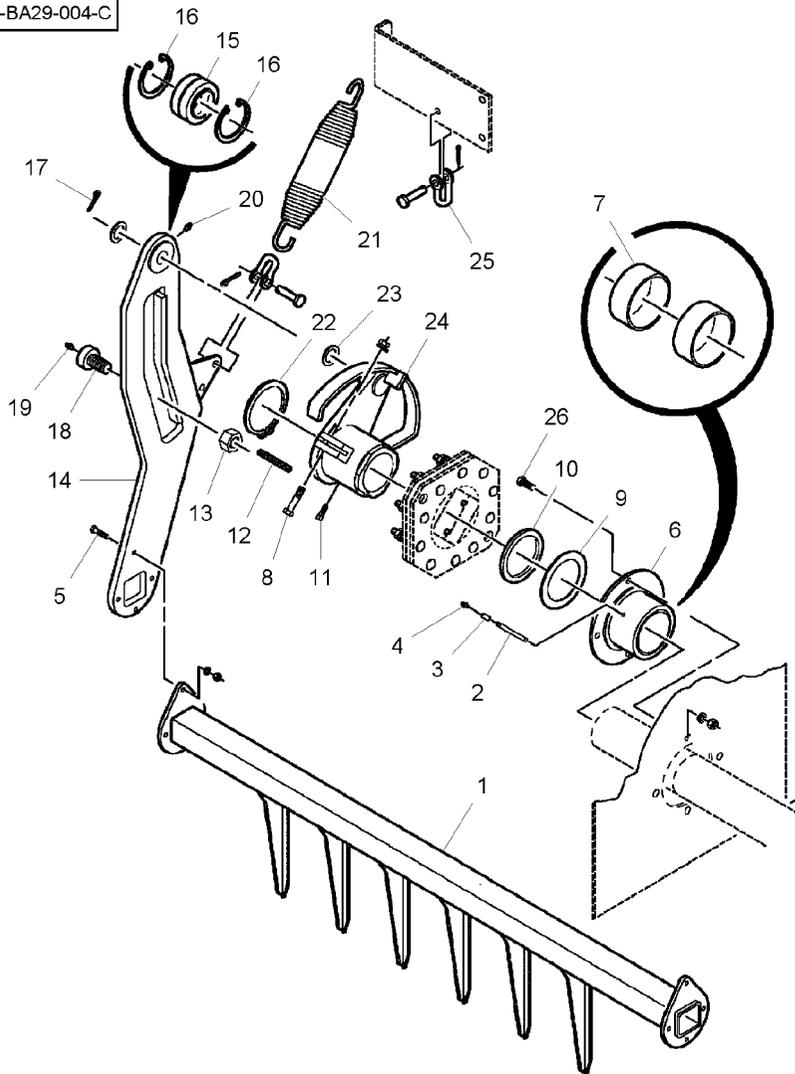

1	★700112840P		1	FINGER	DOIGT	FINGER
2	8746042	[A]	1	NIPPLE	DITO	DEDO
3	70915955	[A]	1	NIPPLE	GRAISSEUR COUDE	NIPPEL
4	70914465	[A]	1	ELBOW	NIPPLO	NIPLE
5	★70921969	1/8" X 90°	1	GREASE NIPPLE	COUDE	WINKELSTUECK
5	★70916965	1/8"-27	1	GREASE NIPPLE	GOMITO	CODO
5	★70916950	3/8"-16 X 1-1/2	1	GREASE NIPPLE	GRAISSEUR DROIT	FETT-NIPPEL
6	★700112876P	3/8"	4	CAPSCREW	INGRASSAT.	ENGRASADOR
7	★700112892	3/8"-16	4	CAPSCREW	VIS BOUCHON	HUTSCHRAUBE
8	★70924864	190LB-50100	4	LOCK WASHER	TAPPO A VITE	TORNILLO TAPON
8	★70922645	1/2"-13 X 2-1/4	4	LOCK WASHER	RONDELLE FREIN	FEDERRING
8	★Y705046	190LB-50101	4	LOCK WASHER	ROSETTA DENTELL.	ARANDELA GROWER
8	★704031	1/2"	4	NUT	ECROU	MUTTER
9	★700112885P	1/2"-13	1	SUPPORT	DADO	TUERCA
10	★700112886P		1	SUPPORT	SUPPORT	LAGERUNG
11	★70923326	3/8"-16 X 1	2	BEARING	SUPPORTO	DISPOS.DE SOSTEN
12	6201404	5/16X5/16X3-3/4	2	BEARING	COUSSINET	LAGER
13	★70929602	1"-1/8-12	2	CAPSCREW	CUSCINETTO	COJINETE
14	★700138869		2	CAPSCREW	VIS BOUCHON	HUTSCHRAUBE
15	712810	14	2	CAPSCREW	TAPPO A VITE	TORNILLO TAPON
16	70927700	14	2	CAPSCREW	VIS BOUCHON	HUTSCHRAUBE
17	62307	1/4" X 2	2	LOCK WASHER	TAPPO A VITE	TORNILLO TAPON
18	7713837		2	LOCK WASHER	RONDELLE FREIN	FEDERRING
19	★70930680	3/16"	2	NUT	ROSETTA DENTELL.	ARANDELA GROWER
20	★70915276	1/8"-27 X 90°	2	NUT	ECROU	MUTTER
21	★7758758		1	WASHER	DADO	TUERCA
			1	WASHER	RONDELLE	UNTERLEGSCHIEBE
			1	SPACER	RONDELLA	ARANDELA
			1	SETSCREW	ENTRETROISE	ABSTANDSTUECK
			1	KEY	DISTANZIALE	DISCO ESPACIADOR
			1	NUT	VIS DE BLOCAGE	STELLSCHRAUBE
			1	ARM	INSIEME VITI	SET SCREW
			1	ARM	CLAVETTE	PASSKEIL
			1	BUSH	CHIAVETTA	CLAVE
			1	BUSH	ECROU	MUTTER
			1	BUSH	DADO	TUERCA
			2	RING	BRAS	ARM
			1	PIN	BRACCIO	BRAZO
			1	BEARING	BAGUE	BUCHSE
			1	PIN	BOCCOLA	CASQUILLO
			1	PIN	ANNEAU	RING
			1	NIPPLE	ANELLO	ARO
			1	SPRING	GOUPILLE	BOLZEN
			1	SPRING	PERNO	PASADOR
			1	SPRING	COUSSINET	LAGER
			1	SPRING	CUSCINETTO	COJINETE
			1	SPRING	GOUPILLE	BOLZEN
			1	SPRING	PERNO	PASADOR
			1	SPRING	GRAISSEUR COUDE	NIPPEL
			1	SPRING	NIPPLO	NIPLE
			1	SPRING	RESSORT	FEDER
			1	SPRING	MOLLA	RESORTE

Finger
Ameneurs
Zubringer
Infaldatore
Embocador

40-35

Right Side
Cote Droit
Rechte Seite
Lato Destro
Lado Derecho

5-BA29-004-C

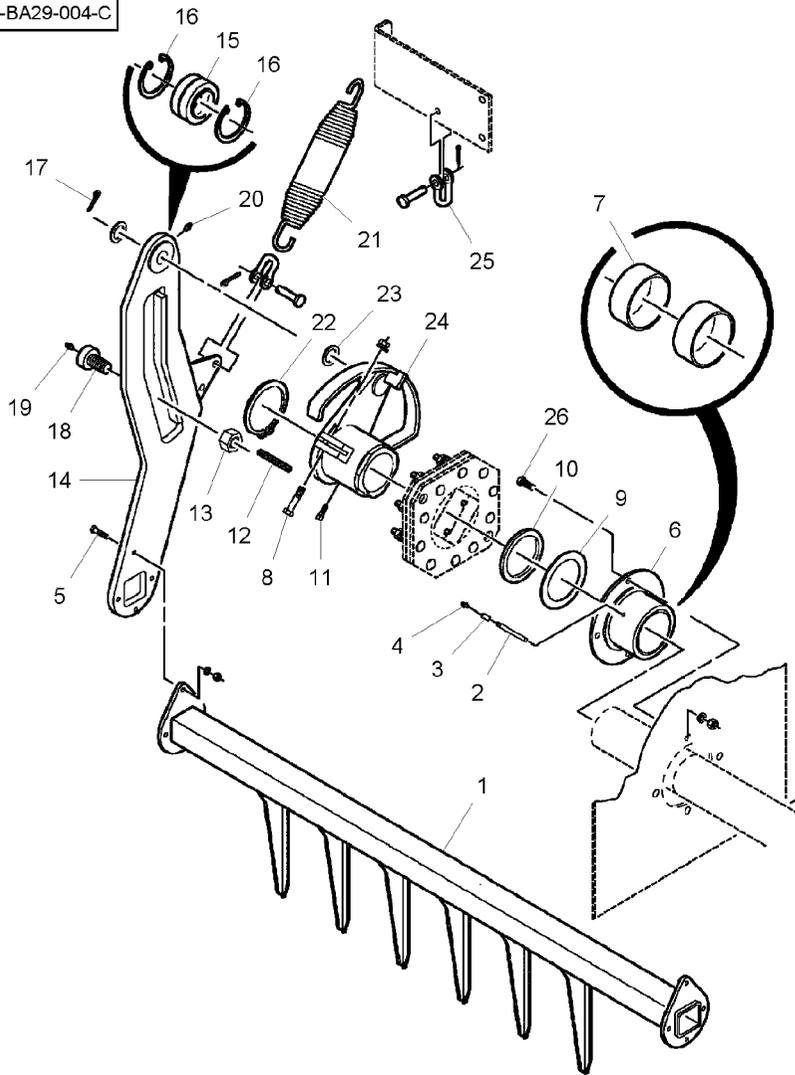

22★7852148

23★Y52324

1"-1/4 X 10

24★700112860P



25★Y766113

26★70921176

1/2"-13 X 1-1/4

26★Y705046

1/2"

26★704031

1/2"-13

1 RING

2 BUSH

1 CRANK

2 CLEVIS

4 CAPSCREW

4 LOCK WASHER

4 NUT

ANNEAU

ANELLO

BAGUE

BOCCOLA

MANIVELLE

MANOVELLA

CHAPE

GANCIO D'ATTACCO

VIS BOUCHON

TAPPO A VITE

RONDELLE FREIN

ROSETTA DENTELL.

ECROU

DADO

RING

ARO

BUCHSE

CASQUILLO

KURBEL

MANIVELA

GABELSTUECK

GANCHO SEGURI.

HUTSCHRAUBE

TORNILLO TAPON

FEDERRING

ARANDELA GROWER

MUTTER

TUERCA

[A] USED ONLY ON UNIT WITHOUT CENTRALIZED LUBRICATION SYSTEM
UTILISE A DEFAUT DE LUBRIFICATION CENTRALISE
VERWENDEN WENN KEINE ZENTRALSCHMIERUNG
UTIZZARE SE NON LUBRIFICAZIONE CENTRALE
USAR SI NO ENGRASE CENTRAL

Finger
Ameneurs
Zubringer
Infaldatore
Embocador

40-40

Brakes
Frein
Bremse
Freni
Freno

5-BA29-017-A

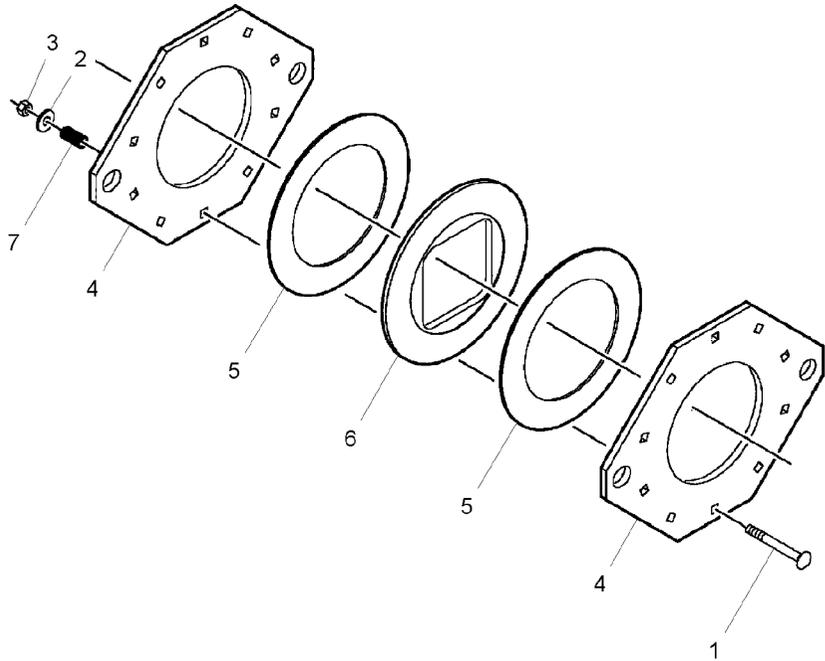

1	★70931359	3/8"-16 X 3-1/2	10	BOLT	BOULON	MASCH.SCHRAUBE
2	★70917378	3/8"	10	FLAT WASHERS	BULLONE	ESPIGA/BULON
3	★70919439	3/8"-16			RONDELLES PLATES	UNTERLEGSCHIEBEN
4	★6818561				RONDELLE PIANA	ARANDELAS PLANAS
5	★700710946		10	NUT	ECROU	MUTTER
6	★700112875P		2	PLATE	DADO	TUERCA
7	★758011		2	CLUTCH DISC	PLAQUE	PLATTE
					PIASTRA	PLATO
			2	BRAKE DISC	DISQUE EMBRAYAGE	KUPPLUNGSSCHIEBE
			1	SPRING	DISCO FRIZIONE	DISCO DE EMBRAGU
					DISQUE DE FREIN	BREMSSCHIEBE
					DISCO FRENO	DISCO DE FRENO
					RESSORT	FEDER
					MOLLA	RESORTE

Charge And Plunger
Alimentation
Zubringer
Alimentatore
Alimentazione

40-45

5-BA04-003-C

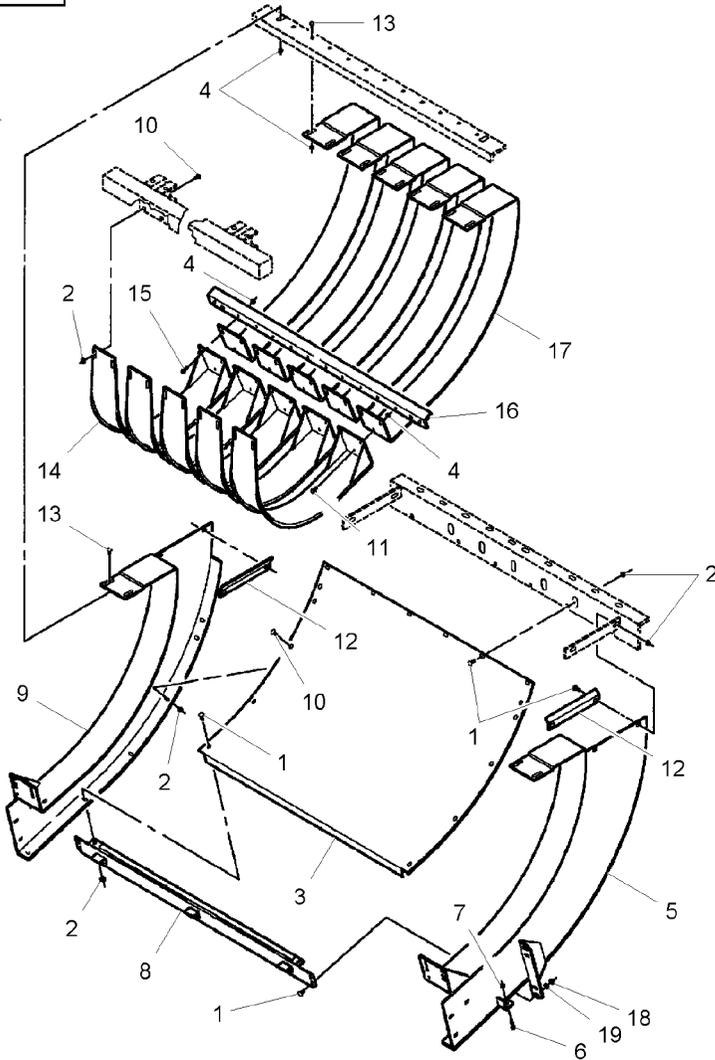

1	70922786	3/8"-16 X 1	16 BOLT	BOULON BULLONE	MASCH.SCHRAUBE ESPIGA/BULON
2	704247	3/8"-16	26 NUT	ECROU DADO	MUTTER TUERCA
3	700112814P		1 PANEL	PANNEAU PANNELLO	VERKL.BLECH PANELAJE
4	70931277	5/16"-18	29 NUT	ECROU DADO	MUTTER TUERCA
5	700112802	➡ 190LB-50146	1 PANEL	PANNEAU PANNELLO	VERKL.BLECH PANELAJE
5	700134987P	➡ 190LB-50147	1 PANEL	PANNEAU PANNELLO	VERKL.BLECH PANELAJE
6	772434	3/8"-16 X 1-1/4	1 CAPSCREW	VIS BOUCHON TAPPO A VITE	HUTSCHRAUBE TORNILLO TAPON
7	70916950	3/8"-16	1 NUT	ECROU DADO	MUTTER TUERCA
8	6844724	➡ 190LB-50146	1 SUPPORT	SUPPORT SUPPORTO	LAGERUNG DISPOS.DE SOSTEN
8	700134990P	➡ 190LB-50147	1 SUPPORT	SUPPORT SUPPORTO	LAGERUNG DISPOS.DE SOSTEN
9	700112803	➡ 190LB-50146	1 PANEL	PANNEAU PANNELLO	VERKL.BLECH PANELAJE
9	700134988	➡ 190LB-50147	1 PANEL	PANNEAU PANNELLO	VERKL.BLECH PANELAJE
10	70922784	3/8"-16 X 3/4	14 BOLT	BOULON BULLONE	MASCH.SCHRAUBE ESPIGA/BULON
11	Y703132	5/16"-18 X 3/4	5 SCREW	VIS VITE	SCHRAUBE TORNILLO
12	6579742P		2 ANGLE.	EQUERRE ANGOLO	WINKEL ANGULO
13	7700461	5/16"-18 X 3/4	14 BOLT	BOULON BULLONE	MASCH.SCHRAUBE ESPIGA/BULON
14	700112800P		5 WRAPPER	COUVERTURE IMBALLATORE	UMSCHLAG ENVASE
15	7772049	5/16"-18 X 1	10 CAPSCREW	VIS BOUCHON TAPPO A VITE	HUTSCHRAUBE TORNILLO TAPON
16	700112819P		1 ANGLE.	EQUERRE ANGOLO	WINKEL ANGULO
17	700112811P		5 STRAP	PATTE CORREGGIA	LASCHE FAJA
18	700711238	➡ 190LB-50147 3/8"-16	4 LOCKNUT	ECROU BLOCAGE AUTOBLOCCANTE	SICHERUNGSMUTTER CONTRATUERCA
19	Y705533	➡ 190LB-50147 3/8"	4 WASHER	RONDELLE RONDELLA	UNTERLEGSCHIBE ARANDELA

Charge And Plunger
Alimentation
Zubringer
Alimentatore
Alimentacione

40-50

Mechanism
Mecanisme
Mechanismus
Meccanismo
Mecanismo

5-BA04-004-B

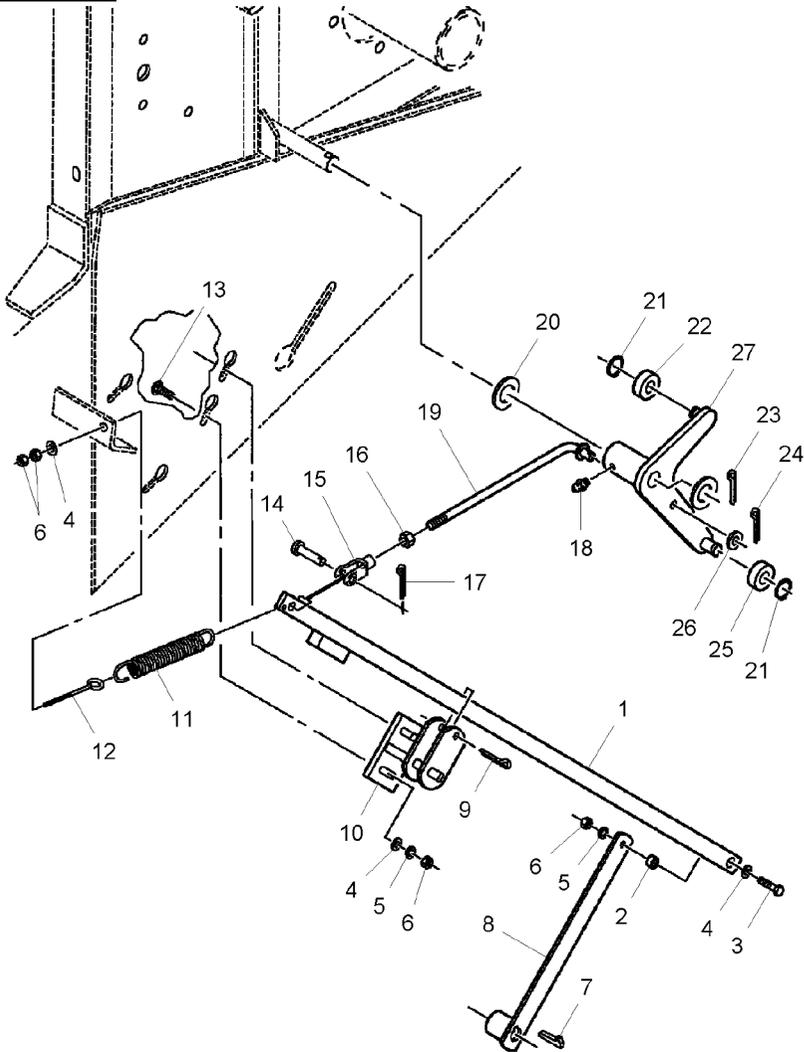

1	700112872P		1	ARM	BRAS	ARM
2	6179832P		1	SPACER	BRACCIO	BRAZO
3	★70921969	3/8"-16 X 1-1/2	1	CAPSCREW	ENTRETOISE	ABSTANDSTUECK
4	Y705533	3/8"			DISTANZIALE	DISCO ESPACIADOR
5	★70916965	3/8"	1	WASHER	VIS BOUCHON	HUTSCHRAUBE
6	★70916950	3/8"-16	4	WASHER	TAPPO A VITE	TORNILLO TAPON
7	61978	1/4" X 2-1/2			RONDELLE	UNTERLEGSCHIEBE
8	6524946P		3	LOCK WASHER	RONDELLA	ARANDELA
9	62307	1/4" X 2			RONDELLE FREIN	FEDERRING
10	700112869P		5	NUT	ROSETTA DENTELL.	ARANDELA GROWER
11	858308				ECROU	MUTTER
12	766485	3/8" X 5	1	KEY	DADO	TUERCA
13	★70923220	3/8"-16 X 1-1/4	1	ARM	CLAVETTE	PASSKEIL
14	70929593	1/2" X 1-1/2			CHIAVETTA	CLAVE
15	70937465		1	ARM	BRAS	ARM
16	★704031	1/2"-13	1	PIN	BRACCIO	BRAZO
17	★70918452	1/8" X 1	1	STOP	GOUPILLE	BOLZEN
18	70914465	[A] 1/8"-27	1	STOP	PERNO	PASADOR
19	700112882P		1	STOP	BUTEE	ANSCHLAG
20	705574	1"	1	SPRING	STOP	PARO
21	★70927732		1	SPRING	RESSORT	FEDER
22	6525042P		1	SPRING	MOLLA	RESORTE
23	★932036	3/16" X 1-1/2	1	EYE BOLT	BOULON A OEIL	AUGENSCHRAUBE
24	354076X1	3/16" X 1	2	BOLT	GOLFARE	CANCAMO
25	6524870P		1	BOLT	BOULON	MASCH.SCHRAUBE
26	705541	1/2"	1	PIN	BULLONE	ESPIGA/BULON
			1	PIN	GOUPILLE	BOLZEN
			1	YOKE	PERNO	PASADOR
			1	NUT	CHAPE ARTICULAT	GELENKGABEL
			1	PIN	FORCELLA	YUGO
			1	GREASE NIPPLE	ECROU	MUTTER
			1	ROD	DADO	TUERCA
			2	FLAT WASHERS	GOUPILLE	BOLZEN
			2	SNAPRING	PERNO	PASADOR
			1	ROLLER	GRAISSEUR DROIT	FETT-NIPPEL
			1	PIN	INGRASSAT.	ENGRASADOR
			1	PIN	TRINGLE	STANGE
			1	PIN	ASTA	VARILLA
			1	ROLLER	RONDELLES PLATES	UNTERLEGSCHIEBEN
			1	WASHER	RONDELLE PIANA	ARANDELAS PLANAS
					SEGMENT ARRET	SPRENGRING
					ANELLO SIEGER	ANILLA RETENCION
					GALET	ROLLE
					RULLO	RODILLO
					GOUPILLE	BOLZEN
					PERNO	PASADOR
					GOUPILLE	BOLZEN
					PERNO	PASADOR
					GALET	ROLLE
					RULLO	RODILLO
					RONDELLE	UNTERLEGSCHIEBE
					RONDELLA	ARANDELA

Charge And Plunger
Alimentation
Zubringer
Alimentatore
Alimentazione

40-50

Mechanism
Mecanisme
Mechanismus
Meccanismo
Mecanismo

5-BA04-004-B

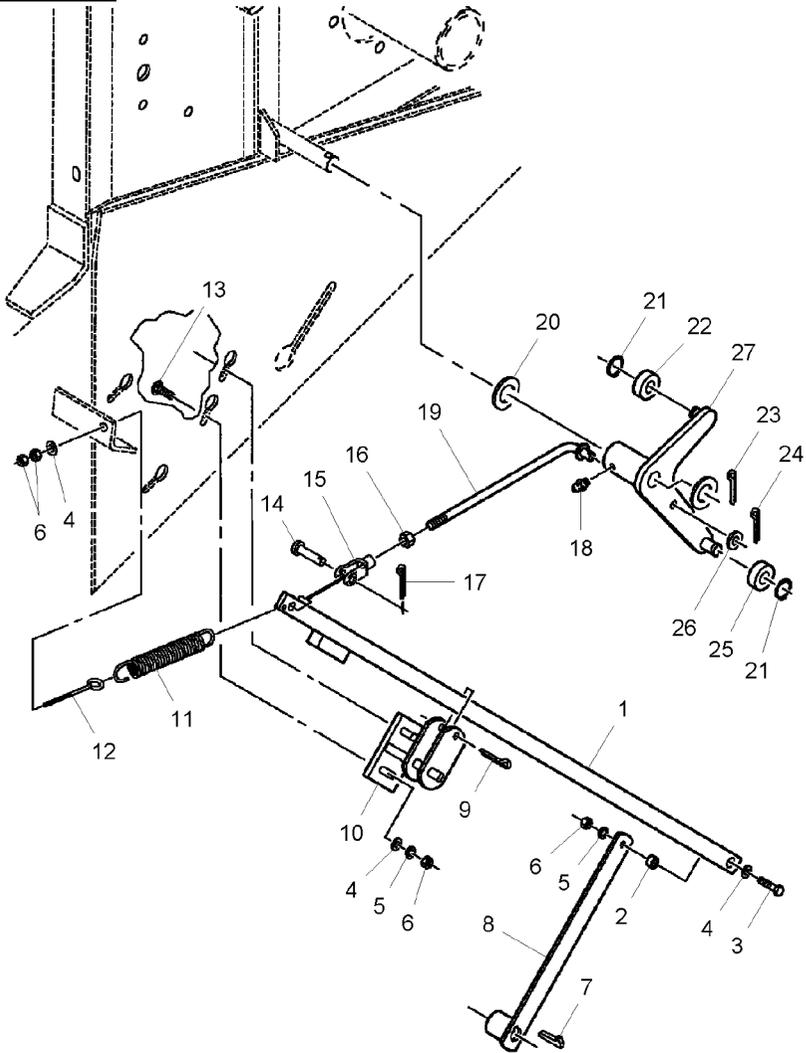

27 700112866P

1 ARM

BRAS
BRACCIO

ARM
BRAZO

[A] USED ONLY ON UNIT WITHOUT CENTRALIZED LUBRICATION SYSTEM
UTILISE A DEFAUT DE LUBRIFICATION CENTRALISE
VERWENDEN WENN KEINE ZENTRALSCHMIERUNG
UTIZZARE SE NON LUBRIFICAZIONE CENTRALE
USAR SI NO ENGRASE CENTRAL

Finger
Ameneurs
Zubringer
Infaldatore
Embocador

40-55

5-BA29-005-C

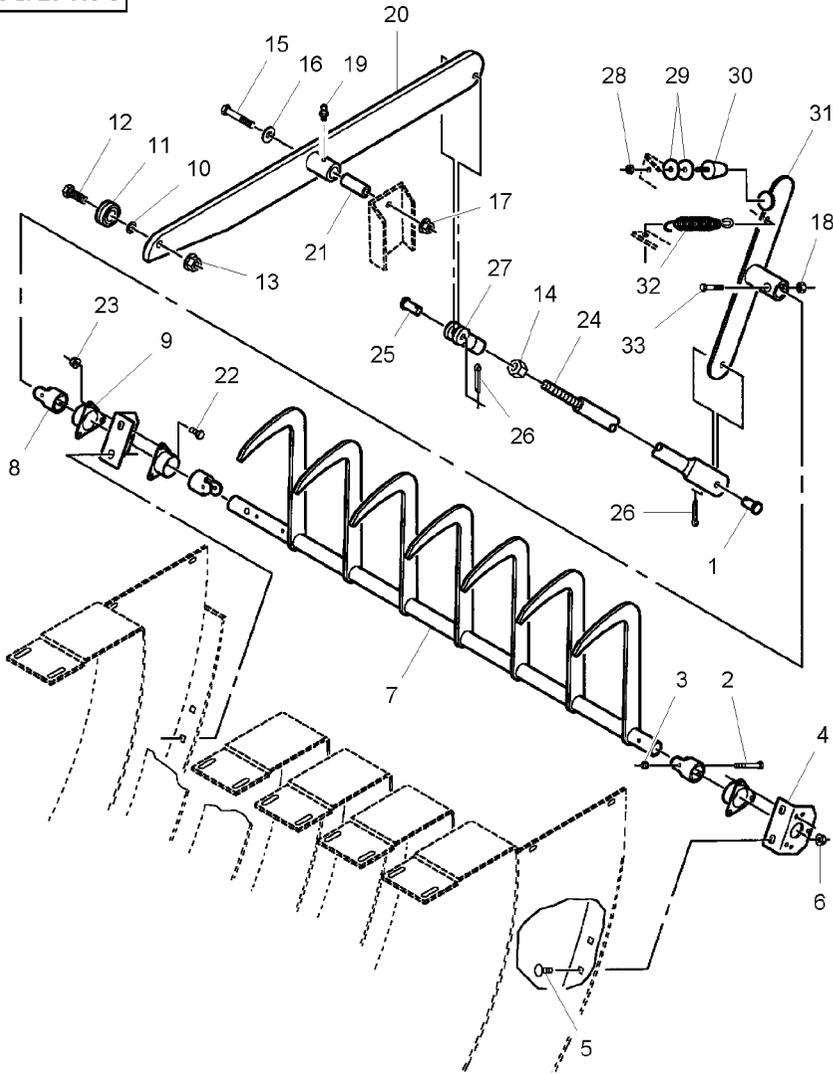

1	700708653	1/2" X 1-1/4	1	PIN	GOUPILLE	BOLZEN
2	★70921963	1/4"-20 X 2	3	CAPSCREW	PERNO	PASADOR
3	7774839	1/4"-20	3	LOCKNUT	VIS BOUCHON	HUTSCHRAUBE
4	6845507P		3	LOCKNUT	TAPPO A VITE	TORNILLO TAPON
5	70922786	3/8"-16 X 1	3	LOCKNUT	ECROU BLOCAGE	SICHERUNGSMUTTER
6	700711238	3/8"-16	2	BRACKET	AUTOBLOCCANTE	CONTRATUERCA
7	700122691P		2	BRACKET	SUPPORT FIXATION	HALTEAM
8	6105159		4	BOLT	STAFFETTA	SOPORTE
9	6105621P		4	BOLT	BOULON	MASCH.SCHRAUBE
10	52233	5/8" X 14	4	LOCKNUT	BULLONE	ESPIGA/BULON
11	711770		4	LOCKNUT	ECROU BLOCAGE	SICHERUNGSMUTTER
12	353727X1	5/8"-11 X 1-3/4	1	FINGER	AUTOBLOCCANTE	CONTRATUERCA
13	700703922	5/8"-11	1	FINGER	DOIGT	FINGER
14	★704031	1/2"-13	1	FINGER	DITO	DEDO
15	★70923320	1/2"-13 X 3	3	BEARING	COUSSINET	LAGER
16	★70918431	1/2"	3	BEARING	CUSCINETTO	COJINETE
17	Y704742	1/2"-13	3	FLANGE	FLASQUE	FLANSCH
18	704858	1/2"-13	3	FLANGE	FLANGIA	PLETINA
19	70914465	[A]	1	BUSH	BAGUE	BUCHSE
20	700112833P	1/8"-27	1	BUSH	BOCCOLA	CASQUILLO
21	700112838P		1	BEARING	COUSSINET	LAGER
22	70922925	➡ 190LB-50100	1	BEARING	CUSCINETTO	COJINETE
22	★70921332	5/16"-18 X 3/4	1	BOLT UNC	BOULON UNC	MASCH.SCHRB.UNC
22	★70921332	➡ 190LB-50101	1	BOLT UNC	BULLONE UNC	PERNO UNC
23	Y704726	5/16"-18	1	LOCKNUT	ECROU BLOCAGE	SICHERUNGSMUTTER
24	★6845630		1	LOCKNUT	AUTOBLOCCANTE	CONTRATUERCA
25	70929593	1/2" X 1-1/2	1	NUT	ECROU	MUTTER
			1	CAPSCREW	DADO	TUERCA
			1	CAPSCREW	VIS BOUCHON	HUTSCHRAUBE
			1	CAPSCREW	TAPPO A VITE	TORNILLO TAPON
			1	WASHER	RONDELLE	UNTERLEGSCHIEBE
			1	WASHER	RONDELLA	ARANDELA
			1	LOCKNUT	ECROU BLOCAGE	SICHERUNGSMUTTER
			1	LOCKNUT	AUTOBLOCCANTE	CONTRATUERCA
			1	LOCKNUT	ECROU BLOCAGE	SICHERUNGSMUTTER
			1	LOCKNUT	AUTOBLOCCANTE	CONTRATUERCA
			1	GREASE NIPPLE	GRAISSEUR DROIT	FETT-NIPPEL
			1	GREASE NIPPLE	INGRASSAT.	ENGRASADOR
			1	LEVER	LEVIER	HEBEL
			1	LEVER	LEVA	PALANCA
			1	SPACER	ENTRETOISE	ABSTANDSTUECK
			6	CAPSCREW	DISTANZIALE	DISCO ESPACIADOR
			6	CAPSCREW	VIS BOUCHON	HUTSCHRAUBE
			6	CAPSCREW	TAPPO A VITE	TORNILLO TAPON
			6	CAPSCREW	VIS BOUCHON	HUTSCHRAUBE
			6	CAPSCREW	TAPPO A VITE	TORNILLO TAPON
			6	LOCKNUT	ECROU BLOCAGE	SICHERUNGSMUTTER
			6	LOCKNUT	AUTOBLOCCANTE	CONTRATUERCA
			1	ROD	TRINGLE	STANGE
			1	ROD	ASTA	VARILLA
			1	PIN	GOUPILLE	BOLZEN
			1	PIN	PERNO	PASADOR

Finger
Ameneurs
Zubringer
Infaldatore
Embocador

40-55

5-BA29-005-C

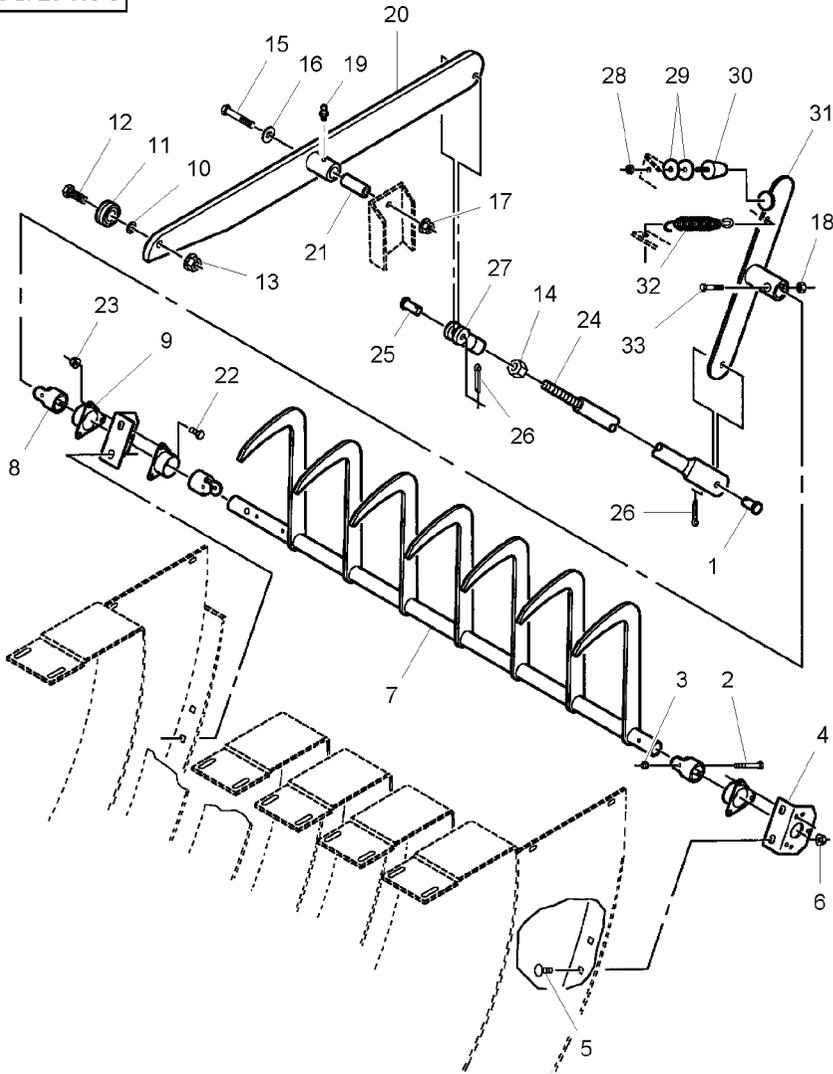

26	70918452	1/8" X 1	2	PIN	GOUILLE	BOLZEN
27	70937465	1/2"-13	1	YOKE	PERNO	PASADOR
28	704536	5/16"-24	1	LOCKNUT	CHAPE ARTICULAT	GELENKGABEL
29	700710049	3/8"	2	WASHER	FORCELLA	YUGO
30	827568		1	BUMPER	ECROU BLOCAGE	SICHERUNGSMUTTER
31	700123488		1	ARM	AUTOBLOCCANTE	CONTRATUERCA
32	7058985	➔ 190LB-50100	1	SPRING	RONDELLE	UNTERLEGSCHIEBE
32	700714987B	➔ 190LB-50101	1	SPRING	RONDELLA	ARANDELA
33	700706548	1/2"-13 X 2-1/4	1	CAPSCREW	PARE CHOC	STOSSFAENGER

[A] USED ONLY ON UNIT WITHOUT CENTRALIZED LUBRICATION SYSTEM
 UTILISE A DEFAUT DE LUBRIFCATION CENTRALISE
 VERWENDEN WENN KEINE ZENTRALSCHMIERUNG
 UTIZZARE SE NON LUBRIFCAZIONE CENTRALE
 USAR SI NO ENGRASE CENTRAL

GOUILLE	BOLZEN
PERNO	PASADOR
CHAPE ARTICULAT	GELENKGABEL
FORCELLA	YUGO
ECROU BLOCAGE	SICHERUNGSMUTTER
AUTOBLOCCANTE	CONTRATUERCA
RONDELLE	UNTERLEGSCHIEBE
RONDELLA	ARANDELA
PARE CHOC	STOSSFAENGER
PARAURTI	PARAGOLPES
BRAS	ARM
BRACCIO	BRAZO
RESSORT	FEDER
MOLLA	RESORTE
RESSORT	FEDER
MOLLA	RESORTE
VIS BOUCHON	HUTSCHRAUBE
TAPPO A VITE	TORNILLO TAPON

Plunger
Piston
Kolben
Pistone
Stantuffo

40-60

5-BA31-003-B

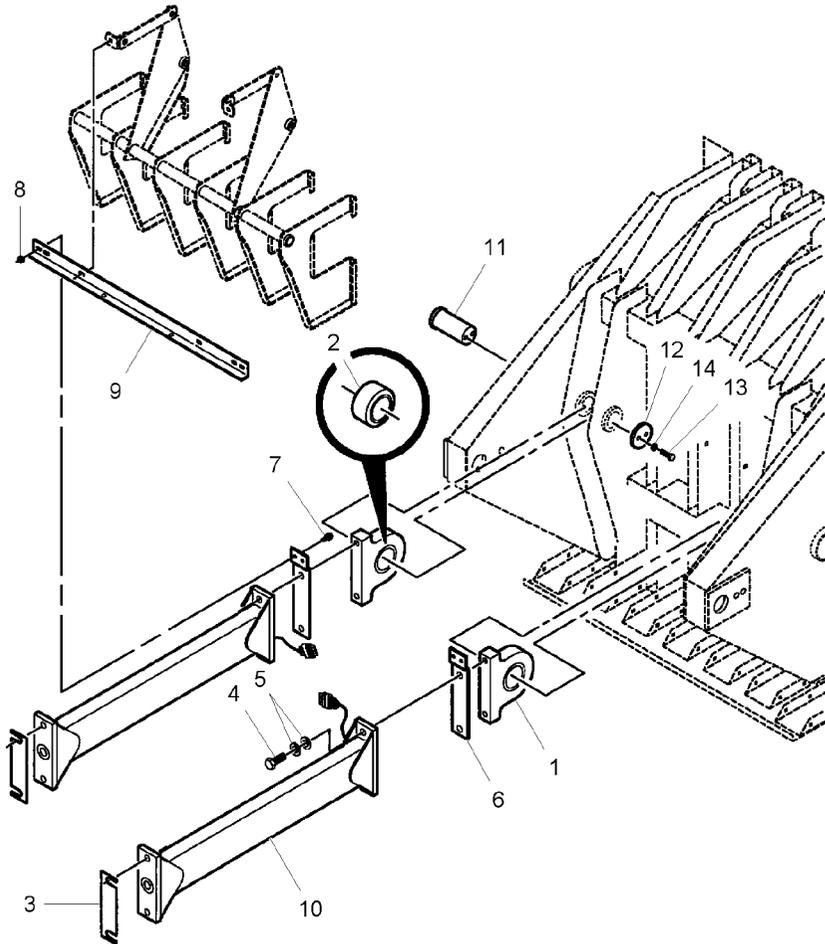

1	700113172P		2	BEARING FLANGE	FLASQUE ROULT	LAGERFLANSCH
2	700723350	1	2	BEARING	BEARING FLANGE	BEARING FLANGE
3	6565675P			COUSSINET	CUSCINETTO	LAGER
4	700706419	3/4"-10 X 2	1	SHIM	CALE REGLAGE	COJINETE
5	Y705566	3/4"		SPESSORE	CALE REGLAGE	EINSTELLBLECH
6	700113660P		8	CAPSCREW	VIS BOUCHON	HUTSCHRAUBE
7	7703424	3/8"-16 X 1		TAPPO A VITE	TAPPO A VITE	TORNILLO TAPON
8	704247	3/8"-16	16	WASHER	RONDELLE	UNTERLEGSCHIEBE
9	700113193P			RONDELLE	RONDELLE	ARANDELA
10	700137258		2	PLATE	PLAQUE	PLATTE
11	700121646			PIASTRA	PIASTRA	PLATO
12	700113192P		4	CAPSCREW	VIS BOUCHON	HUTSCHRAUBE
13	★701235	1/2"-13 X 1-1/2		TAPPO A VITE	TAPPO A VITE	TORNILLO TAPON
14	★Y705046	1/2"	4	NUT	ECROU	MUTTER
				DADO	DADO	TUERCA
			1	ANGLE.	EQUERRE	WINKEL
				ANGOLO	ANGOLO	ANGULO
			2	ROD	TRINGLE	STANGE
				ASTA	ASTA	VARILLA
			2	SHAFT	ARBRE	WELLE
				ALBERO	ALBERO	ARBOL
			2	PLATE	PLAQUE	PLATTE
				PIASTRA	PIASTRA	PLATO
			4	BOLT	BOULON	MASCH.SCHRAUBE
				BULLONE	BULLONE	ESPIGA/BULON
			4	LOCK WASHER	RONDELLE FREIN	FEDERRING
				ROSETTA DENTELL.	ROSETTA DENTELL.	ARANDELA GROWER

Plunger
Piston
Kolben
Pistone
Stantuffo

40-65

5-BA31-004-C

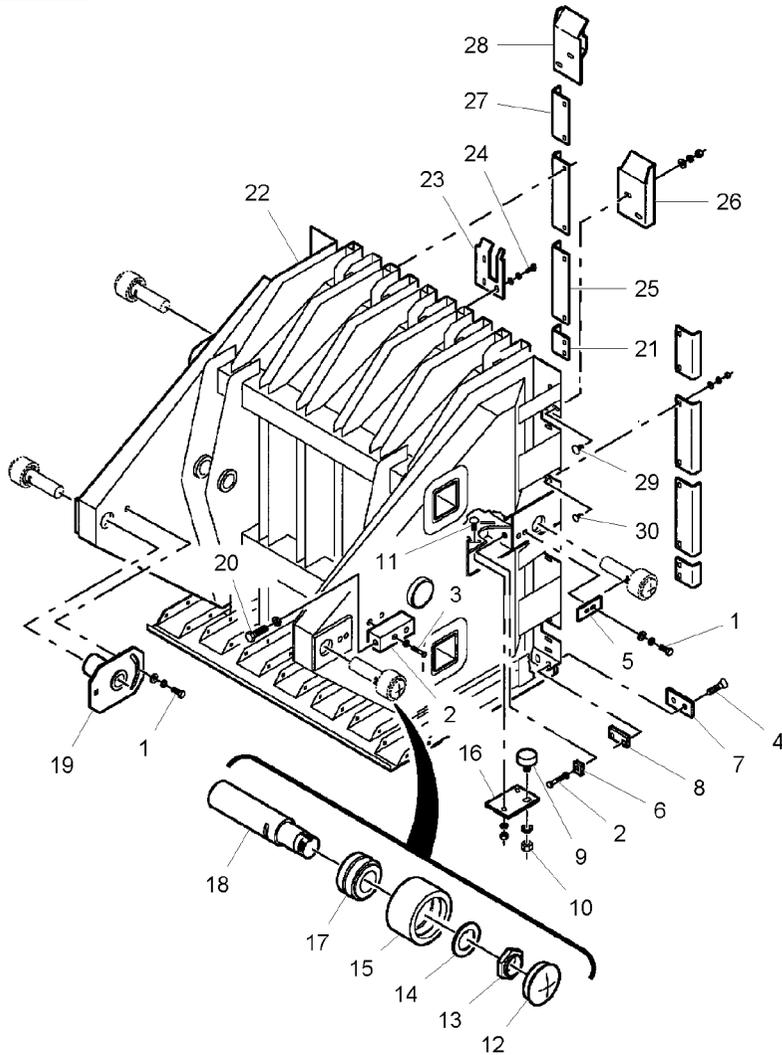

1★70921176	1/2"-13 X 1-1/4	10 CAPSCREW	VIS BOUCHON	HUTSCHRAUBE
1★Y705046	1/2"	10 LOCK WASHER	TAPPO A VITE	TORNILLO TAPON
1★705541	1/2"	10 WASHER	RONDELLE FREIN	FEDERRING
2★700124023		2 BLOCK	ROSETTA DENTELL.	ARANDELA GROWER
3★70921971	3/8"-16 X 1-3/4	4 CAPSCREW	RONDELLE	UNTERLEGSCHIEBE
3★70916965	3/8"	4 LOCK WASHER	RONDELLA	ARANDELA
4★700706852	5/8"-11 X 1-1/2	14 CAPSCREW	BLOC	BLOCK
5★700124022P		4 PLATE	TASSELLO	BLOQUE
6★700124027P		2 PLATE	VIS BOUCHON	HUTSCHRAUBE
7★700113188P		7 KNIFE	TAPPO A VITE	TORNILLO TAPON
8★700113189		7 BAR	RONDELLE FREIN	FEDERRING
9★7713829		2 BEARING	ROSETTA DENTELL.	ARANDELA GROWER
10★70919332	3/4"	2 LOCK WASHER	VIS BOUCHON	HUTSCHRAUBE
10★70930253	3/4"-16	2 LOCKNUT	TAPPO A VITE	TORNILLO TAPON
11★68619	1/2"-13 X 1-1/4	4 BOLT	PLAQUE	PLATTE
11★Y705046	1/2"	4 LOCK WASHER	PIASTRA	PLATO
11★704031	1/2"-13	4 NUT	COUTEAU	MESSER
12★26922		4 CAP	COLTELLO	CUCHILLA
13★700113171	1"-5/16-18	4 NUT	BARRE	STAB
14★700706125		4 WASHER	BARRA	BARRA
15★700113170		4 ROLLER	COUSSINET	LAGER
16★700113176P		2 PLATE	CUSCINETTO	COJINETE
17★700706124		4 BEARING ASSY	RONDELLE FREIN	FEDERRING
18★700124026		4 SHAFT	ROSETTA DENTELL.	ARANDELA GROWER
19★700121644P		2 SUPPORT	ECROU BLOCAGE	SICHERUNGSMUTTER
20★70920415	3/8"-16 X 1-1/4	2 CAPSCREW	AUTOBLOCCANTE	CONTRATUERCA
			BOULON	MASCH.SCHRAUBE
			BULLONE	ESPIGA/BULON
			RONDELLE FREIN	FEDERRING
			ROSETTA DENTELL.	ARANDELA GROWER
			ECROU	MUTTER
			DADO	TUERCA
			CHAPEAU	KAPPE
			CAPUCHON	TAPA
			ECROU	MUTTER
			DADO	TUERCA
			RONDELLE	UNTERLEGSCHIEBE
			RONDELLA	ARANDELA
			GALET	ROLLE
			RULLO	RODILLO
			PLAQUE	PLATTE
			PIASTRA	PLATO
			ROULEMENT	RADIALLAGER
			CUSCINETTO COMPL	RODAMIENTO RAD
			ARBRE	WELLE
			ALBERO	ARBOL
			SUPPORT	LAGERUNG
			SUPPORTO	DISPOS.DE SOSTEN
			VIS BOUCHON	HUTSCHRAUBE
			TAPPO A VITE	TORNILLO TAPON

Plunger
Piston
Kolben
Pistone
Stantuffo

40-65

5-BA31-004-C

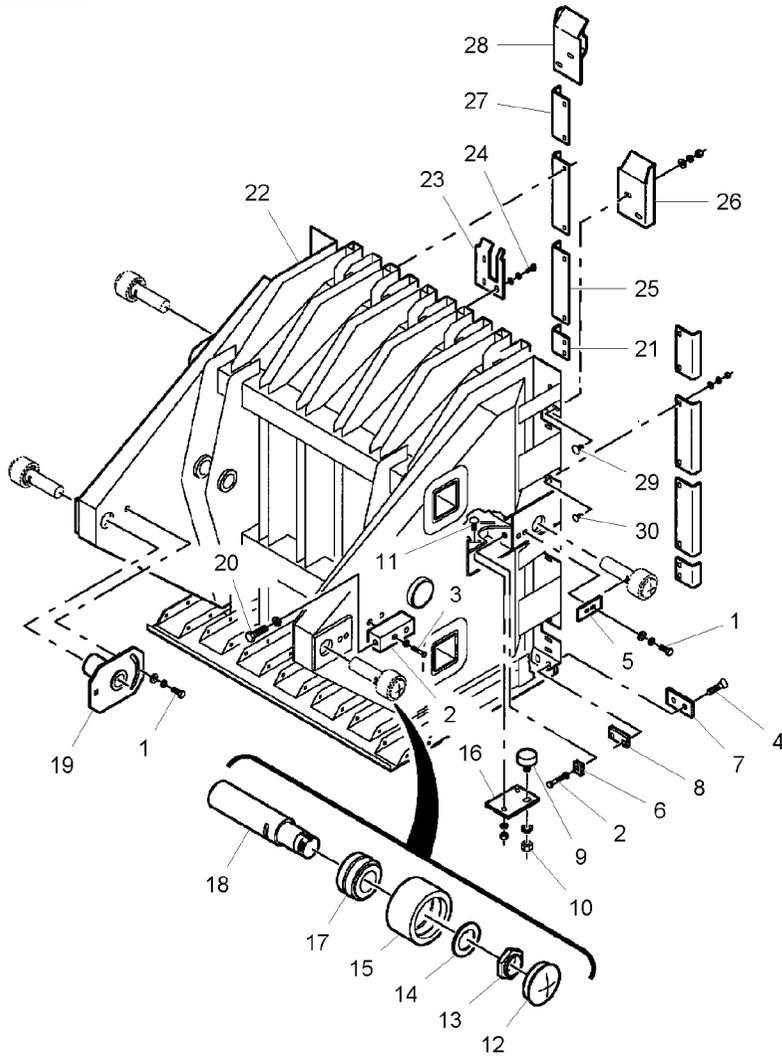

20★70917421	3/8"-16	2 NUT	ECROU DADO	MUTTER TUERCA
21★700113186P		2 ANGLE.	EQUERRE ANGOLO	WINKEL ANGULO
22★700121641		1 PLUNGER	PLONGEUR STANTUFFO	TAUCHKOLBEN EMBOLO
23★700113187P		5 PLATE	PIASTRA PIASTRA	PLATTE PLATO
24★70921210	3/8"-16 X 1	15 CAPSCREW	VIS BOUCHON TAPPO A VITE	HUTSCHRAUBE TORNILLO TAPON
24★70916965	3/8"	15 LOCK WASHER	RONDELLE FREIN ROSETTA DENTELL.	FEDERRING ARANDELA GROWER
24★Y705533	3/8"	15 WASHER	RONDELLE RONDELLA	UNTERLEGSCHIEBE ARANDELA
25★700113185P		4 ANGLE.	EQUERRE ANGOLO	WINKEL ANGULO
26★700113177	◀	1 PLATE	PLAQUE PIASTRA	PLATTE PLATO
27★700113184P		2 ANGLE.	EQUERRE ANGOLO	WINKEL ANGULO
28★700113178	▶	1 PLATE	PLAQUE PIASTRA	PLATTE PLATO
29★70928367	1/2"-13 X 1	4 BOLT	BOULON BULLONE	MASCH.SCHRAUBE ESPIGA/BULON
29★705541	1/2"	4 WASHER	RONDELLE RONDELLA	UNTERLEGSCHIEBE ARANDELA
29★Y705046	1/2"	4 LOCK WASHER	RONDELLE FREIN ROSETTA DENTELL.	FEDERRING ARANDELA GROWER
29★704031	1/2"-13	4 NUT	ECROU DADO	MUTTER TUERCA
30★70922786	3/8"-16 X 1	16 BOLT	BOULON BULLONE	MASCH.SCHRAUBE ESPIGA/BULON
30★Y705533	3/8"	16 WASHER	RONDELLE RONDELLA	UNTERLEGSCHIEBE ARANDELA
30★70916965	3/8"	16 LOCK WASHER	RONDELLE FREIN ROSETTA DENTELL.	FEDERRING ARANDELA GROWER
30★70916950	3/8"-16	16 NUT	ECROU DADO	MUTTER TUERCA

Plunger
Piston
Kolben
Pistone
Stantuffo

40-70

5-BA31-005-B

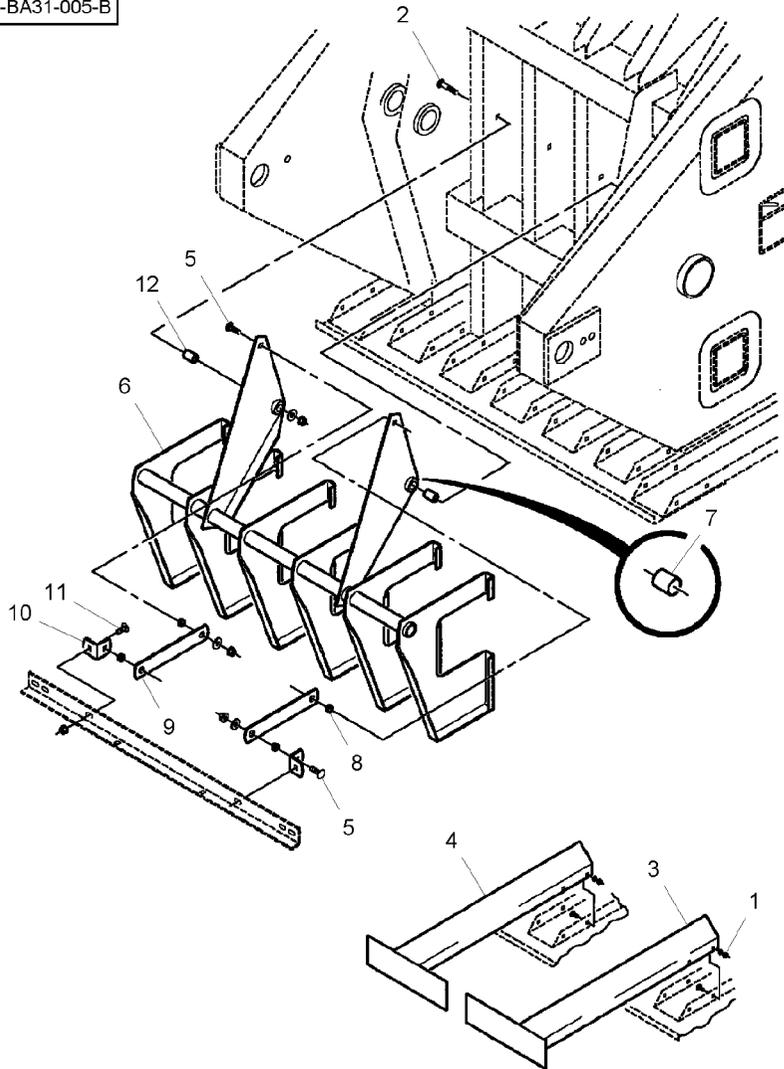

1★7883325	5/16"-18 X 3/4	8 SCREW	VIS	SCHRAUBE
1★Y704726	5/16"-18	8 LOCKNUT	VITE	TORNILLO
2★7700073	3/8"-16 X 2	2 BOLT	ECROU BLOCAGE	SICHERUNGSMUTTER
2★70917378	3/8"	2 FLAT WASHERS	AUTOBLOCCANTE	CONTRATUERCA
2★Y704734	3/8"-16	2 LOCKNUT	BOULON	MASCH.SCHRAUBE
3★700114014P	◀	1 SCRAPER	BULLONE	ESPIGA/BULON
4★700114015	▶	1 SCRAPER	RONDELLES PLATES	UNTERLEGSCHIEBEN
5★70923220	3/8"-16 X 1-1/4	4 BOLT	RONDELLE PIANA	ARANDELAS PLANAS
5★70917378	3/8"	4 FLAT WASHERS	ECROU BLOCAGE	SICHERUNGSMUTTER
5★Y704734	3/8"-16	4 LOCKNUT	AUTOBLOCCANTE	CONTRATUERCA
6★700122582		1 BLADE	RACLEUR	ABSTREICHER
7★Y740787	6	2 BUSH	RUSPA	RASPADOR
8★6232946P		4 BUSH	RACLEUR	ABSTREICHER
9★700122587P		2 STRAP	RUSPA	RASPADOR
10★700122588P		2 ANGLE.	BOULON	MASCH.SCHRAUBE
11★70922786	3/8"-16 X 1	2 BOLT	BULLONE	ESPIGA/BULON
11★Y704734	3/8"-16	2 LOCKNUT	RONDELLES PLATES	UNTERLEGSCHIEBEN
12★6518302B		2 SPACER	RONDELLE PIANA	ARANDELAS PLANAS
			ECROU BLOCAGE	SICHERUNGSMUTTER
			AUTOBLOCCANTE	CONTRATUERCA
			ENTRETOISE	ABSTANDSTUECK
			DISTANZIALE	DISCO ESPACIADOR

--	--	--

50

Needle
Aiguille
Nadeln
Ago
Aguja

50-5

➔ 190LB-50100

5 BA35 002 A

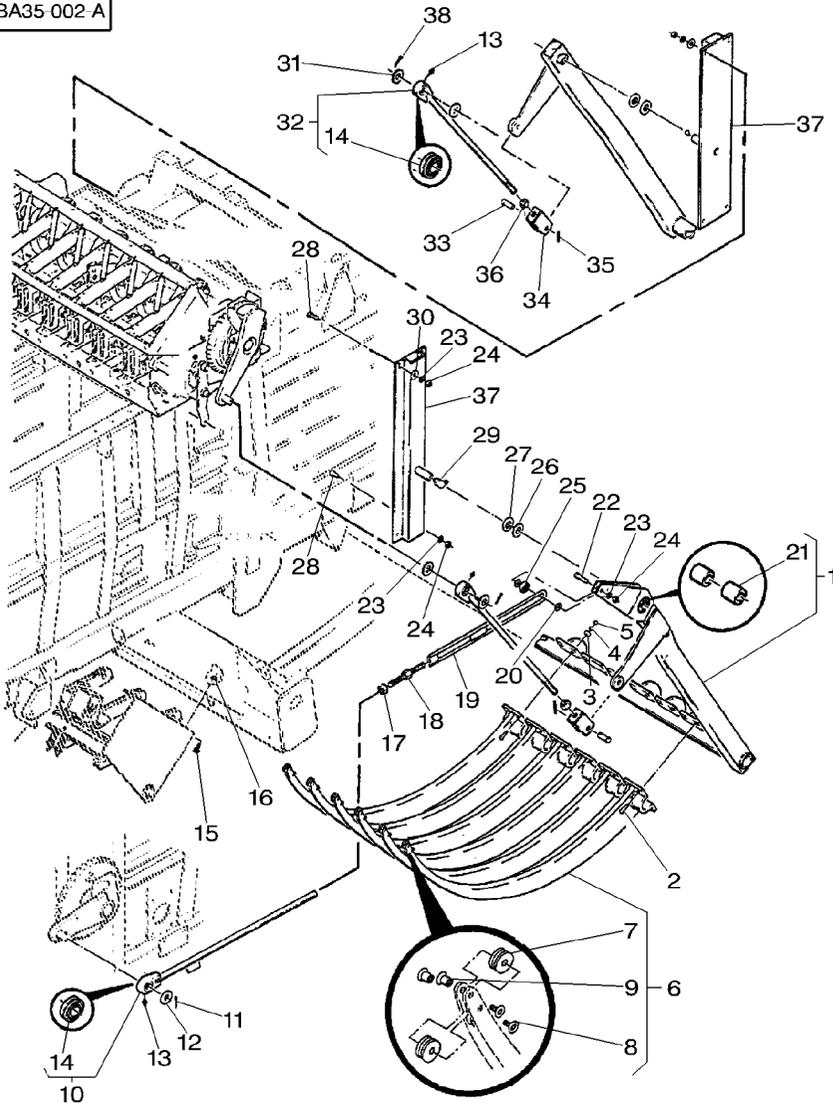

1	★700153217		1	SUPPORT	SUPPORT	LAGERUNG
2	700710413	1/2"-13 X 2-1/2	24	BOLT	SUPPORTO	DISPOS.DE SOSTEN
3	★705541	1/2"	24	WASHER	BOULON	MASCH.SCHRAUBE
4	700703458	1/2"-13			BULLONE	ESPIGA/BULON
5	700710414	1/2"-13	24	NUT	RONDELLE	UNTERLEGSCHIEBE
6	★700122690				RONDELLA	ARANDELA
7	700722661	6	24	NUT	ECROU	MUTTER
8	8701476	6 No 10-32 X 1/2			DADO	TUERCA
9	866566	6	24	NUT	ECROU	MUTTER
10	★6530398P				DADO	TUERCA
11	62307	1/4" X 2	6	NEEDLE	AIGUILLE	NADEL
12	7705197	1"-1/4			AGO	AGUJA
13	70914465	[A]	12	BALL BEARING	ROULEMENT BILLES	KUGELLAGER
14	712810	1/8"-27			CUSCINETTO SFERE	COJINETE DE BOLA
15	7703424	3/8"-16 X 1	12	CAPSCREW	VIS BOUCHON	HUTSCHRAUBE
16	704247	3/8"-16			TAPPO A VITE	TORNILLO TAPON
17	7774391	7/8"-14	12	FASTENER	AGRAFE	HALTEKLAMMER
18	6530604				LACCIO	CIERRE
19	700113098P		1	ROD	TRINGLE	STANGE
20	52233	5/8" X 14			ASTA	VARILLA
21	6849160	1	1	PIN	GOUPILLE	BOLZEN
22	353729X1	5/8"-11 X 2-1/2			PERNO	PASADOR
23	353433X1	5/8"	1	WASHER	RONDELLE	UNTERLEGSCHIEBE
24	375099X1	5/8"-11			RONDELLA	ARANDELA
25	711770		3	GREASE NIPPLE	GRAISSEUR DROIT	FETT-NIPPEL
26	700706146				INGRASSAT.	ENGRASADOR
			2	BUSH	BAGUE	BUCHSE
					BOCCOLA	CASQUILLO
			4	CAPSCREW	VIS BOUCHON	HUTSCHRAUBE
					TAPPO A VITE	TORNILLO TAPON
			4	NUT	ECROU	MUTTER
					DADO	TUERCA
			1	NUT	ECROU	MUTTER
					DADO	TUERCA
			1	ROD	TRINGLE	STANGE
					ASTA	VARILLA
			1	STRAP	PATTE	LASCHE
					CORREGGIA	FAJA
			2	BUSH	BAGUE	BUCHSE
					BOCCOLA	CASQUILLO
			4	BEARING	COUSSINET	LAGER
					CUSCINETTO	COJINETE
			1	BOLT UNC	BOULON UNC	MASCH.SCHRB.UNC
					BULLONE UNC	PERNO UNC
			9	LOCK WASHER	RONDELLE FREIN	FEDERRING
					ROSETTA DENTELL.	ARANDELA GROWER
			9	NUT UNC	ECROU UNC	MUTTER UNC
					DADO UNC	TUERCA UNC
			1	BEARING	COUSSINET	LAGER
					CUSCINETTO	COJINETE
			2	WASHER	RONDELLE	UNTERLEGSCHIEBE
					RONDELLA	ARANDELA

Needle
Aiguille
Nadeln
Ago
Aguja

50-5

➔ 190LB-50100

5 BA35 002 A

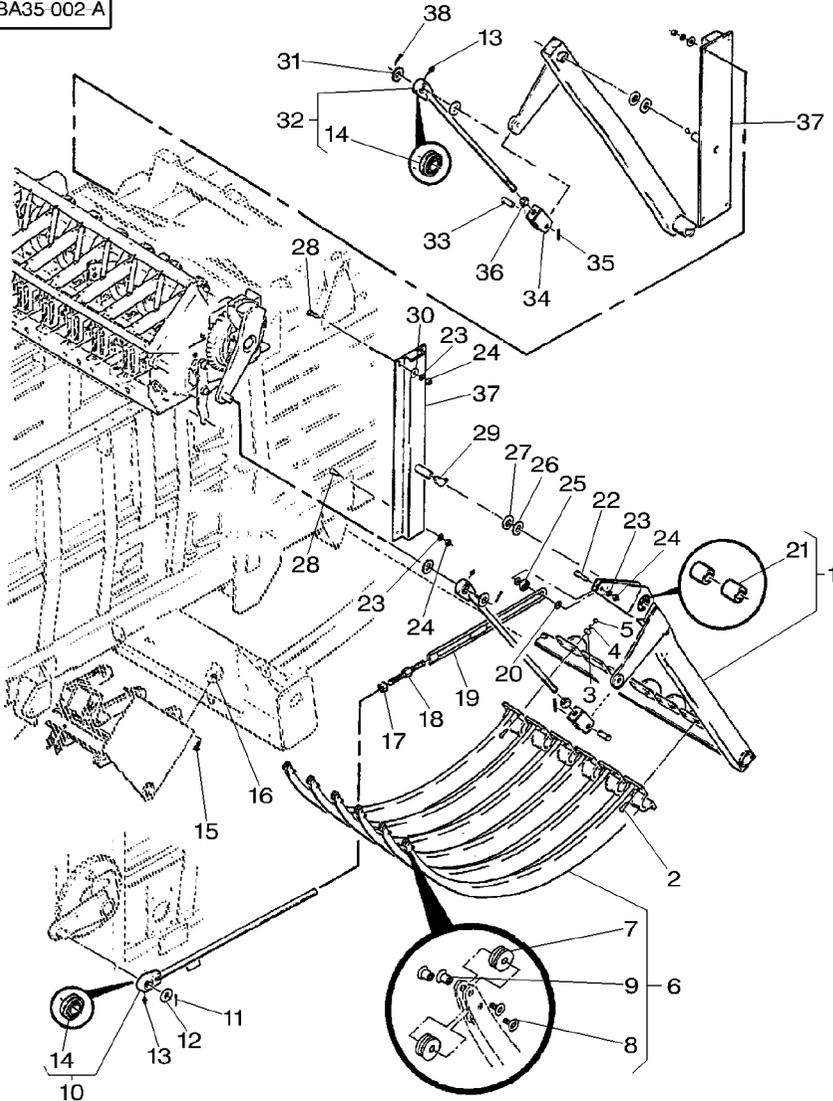

27	Y52944	1"-3/4 X 10	2	BUSH	BAGUE	BUCHSE
28	353726X1	5/8"-11 X 1-1/2	8	BOLT UNC	BOCCOLA	CASQUILLO
29	70915276	[A] 1/8"-27 X 90°	2	NIPPLE	BOULON UNC	MASCH.SCHRB.UNC
30	Y705582	5/8"	2	NIPPLE	BULLONE UNC	PERNO UNC
31	Y52324	1"-1/4 X 10	4	WASHER	GRAISSEUR COUDE	NIPPEL
32	★700113095		4	BUSH	NIPPLLO	NIPLE
33	700709960		2	ROD	RONDELLE	UNTERLEGSCHIEBE
34	6530364P		2	PIN	RONDELLE	ARANDELA
35	70922949	1/4" X 1-1/2	2	CLEVIS	BAGUE	BUCHSE
36	Y704684	1"-8	2	NUT	BOCCOLA	CASQUILLO
37	★700150621		2	PIVOT	TRINGLE	PASADOR
38	70918463	1/4" X 1-3/4	2	PIN	ASTA	VARILLA
					GOUPILLE	BOLZEN
					PERNO	PASADOR
					CHAPE	GABELSTUECK
					GANCIO D'ATTACCO	GANCHO SEGURI.
					GOUPILLE	BOLZEN
					PERNO	PASADOR
					ECROU	MUTTER
					DADO	TUERCA
					PIVOT	DREHZAPFEN
					CARDINE	PIVOTE
					GOUPILLE	BOLZEN
					PERNO	PASADOR

[A] USED ONLY ON UNIT WITHOUT CENTRALIZED LUBRICATION SYSTEM
 UTILISE A DEFAUT DE LUBRIFICATION CENTRALISE
 VERWENDEN WENN KEINE ZENTRALSCHMIERUNG
 UTILIZZARE SE NON LUBRIFICAZIONE CENTRALE
 USAR SI NO ENGRASE CENTRAL

Needle
Aiguille
Nadeln
Ago
Aguja

50-10

➔ 190LB-50101

5-BA35-004-B

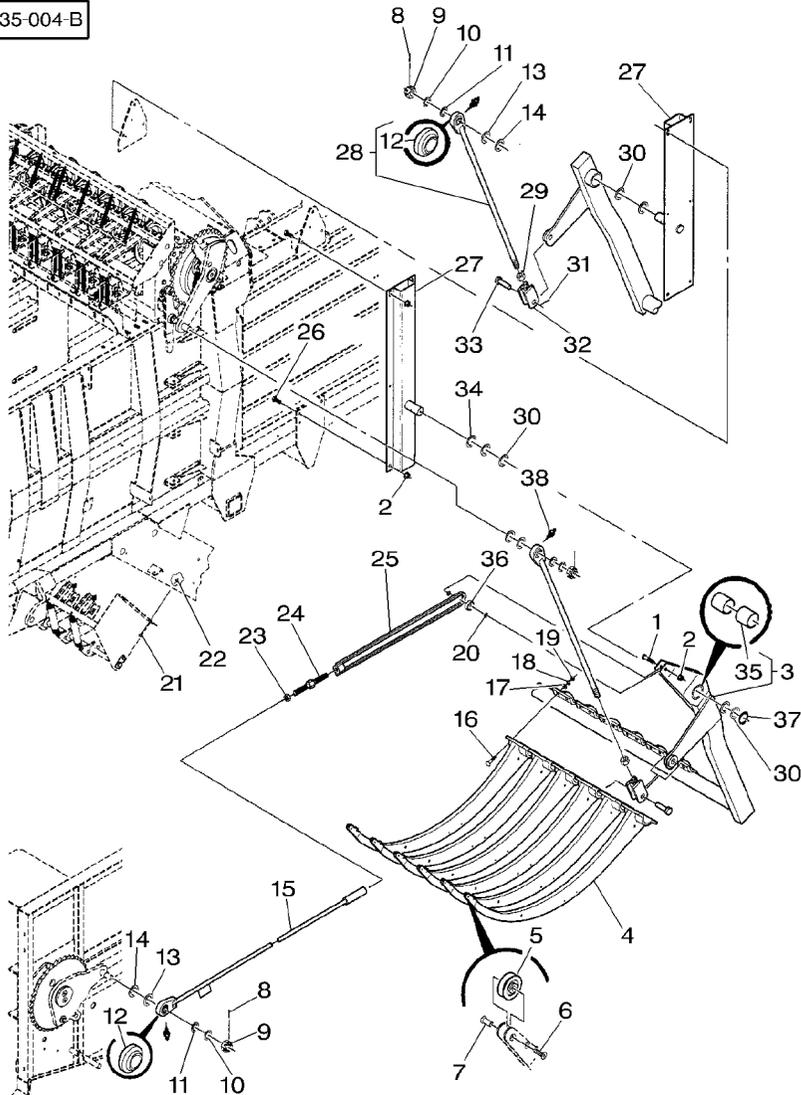

1	★353729X1	5/8"-11 X 2-1/2	1 BOLT UNC	BOULON UNC	MASCH.SCHRB.UNC
2	700703922	5/8"-11	9 LOCKNUT	BULLONE UNC	PERNO UNC
3	★700153217		1 SUPPORT	ECROU BLOCAGE	SICHERUNGSMUTTER
4	★700122690		6 NEEDLE	AUTOBLOCCANTE	CONTRATUERCA
5	700722661	4	12 BALL BEARING	SUPPORT	LAGERUNG
6	8701476	4 No 10-32 X 1/2	12 CAPSCREW	SUPPORTO	DISPOS.DE SOSTEN
7	866566	4 No 10-32	12 FASTENER	AIGUILLE	NADEL
8	62786	1/4" X 2-1/2	3 PIN	AGO	AGUJA
9	704692	1"-14	3 NUT	ROULEMENT BILLES	KUGELLAGER
10	Y52258	1" X 14	3 BUSH	CUSCINETTO SFERE	COJINETE DE BOLA
11	Y52316	1" X 10	3 BUSH	VIS BOUCHON	HUTSCHRAUBE
12	712810		2 BUSH	TAPPO A VITE	TORNILLO TAPON
13	Y52266	1"-1/4 X 14	3 BUSH	AGRAFE	HALTEKLAMMER
14	Y52324	1"-1/4 X 10	3 BUSH	LACCIO	CIERRE
15	★6530398P		1 ROD	GOUPILLE	BOLZEN
16	700710413	1/2"-13 X 2-1/2	24 BOLT	PERNO	PASADOR
17	705541	1/2"	24 WASHER	ECROU	MUTTER
18	700703458	1/2"-13	24 NUT	DADO	TUERCA
19	700710414	1/2"-13	24 NUT	BAGUE	BUCHSE
20	52233	5/8" X 14	2 BUSH	BOCCOLA	CASQUILLO
21	7883382	3/8"-16 X 1	4 SCREW	BAGUE	BUCHSE
22	Y704734	3/8"-16	4 LOCKNUT	BOCCOLA	CASQUILLO
23	7774391	7/8"-14	1 NUT	BOCCOLA	CASQUILLO
24	6530604		1 ROD	BAGUE	BUCHSE
25	700113098P		1 STRAP	BOCCOLA	CASQUILLO
26	★70924744	5/8"-11 X 1-1/2	8 CAPSCREW	TRINGLE	STANGE
				ASTA	VARILLA
				PATTE	LASCHE
				CORREGGIA	FAJA
				VIS BOUCHON	HUTSCHRAUBE
				TAPPO A VITE	TORNILLO TAPON

Needle
Aiguille
Nadeln
Ago
Aguja

50-10

➔ 190LB-50101

5-BA35-004-B

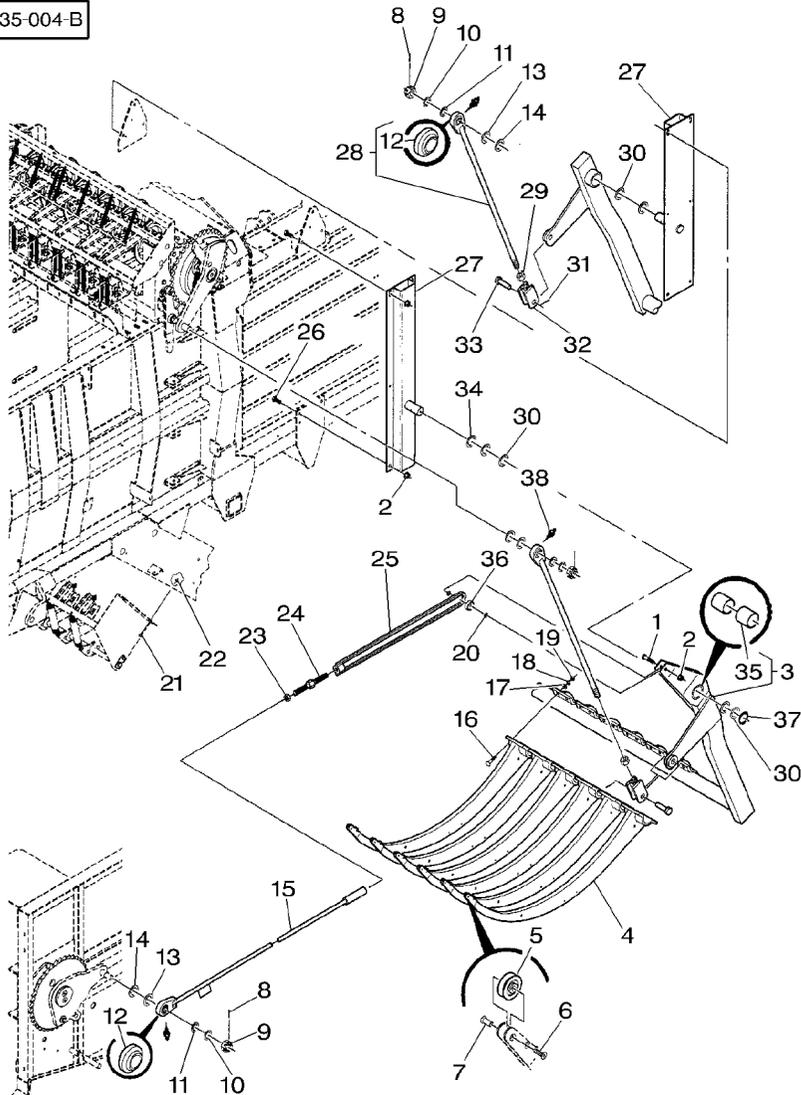

27 *700150621

28 *700113095

29 Y704684

1"-8

30 Y52944

1"-3/4 X 10

31 70922949

1/4" X 1-1/2

32 6530364P

33 700709960

34 700706146

35 **6849160**

3

36 **711770**

37 **700718131**

38 70914465

1/8"-27

2 PIVOT

2 ROD

2 NUT

6 BUSH

2 PIN

2 CLEVIS

2 PIN

3 WASHER

4 BEARING

1 BEARING

2 CIRCLIP

3 GREASE NIPPLE

PIVOT

CARDINE

TRINGLE

ASTA

ECROU

DADO

BAGUE

BOCCOLA

GOUPILLE

PERNO

CHAPE

GANCIO D'ATTACCO

GOUPILLE

PERNO

RONDELLE

RONDELLA

COUSSINET

CUSCINETTO

COUSSINET

CUSCINETTO

CIRCLIP

ANELLO ELASTICO

GRAISSEUR DROIT

INGRASSAT.

DREHZAPFEN

PIVOTE

STANGE

VARILLA

MUTTER

TUERCA

BUCHSE

CASQUILLO

BOLZEN

PASADOR

GABELSTUECK

GANCHO SEGUR.

BOLZEN

PASADOR

UNTERLEGSCHIEBE

ARANDELA

LAGER

COJINETE

LAGER

COJINETE

SEEGERING

GRAPA CIRCULAR

FETT-NIPPEL

ENGRASADOR

Lubrification
 Lubrification
 Schmierer
 Lubrificazione
 Engrase

50-15

Knotter
 Noueur
 Binder
 Legatore
 Anudadora

5-BA16-013-B

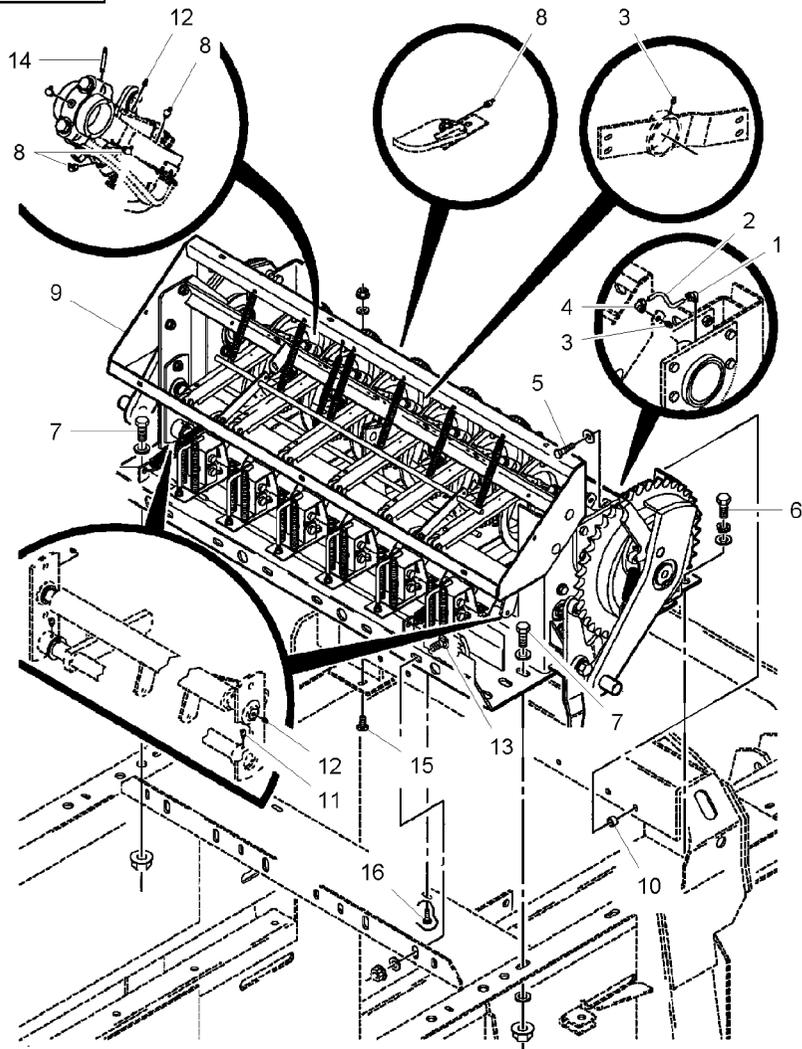

- 1 ★7746035
- 2 ★6845929
- 3 ★70914465
- 4 ★7746829
- 5 ★70919089 1/2"-13 X 1-3/4
- 5 ★70918431 1/2"
- 6 ★70926127 3/4"-10 X 1-3/4
- 6 ★70919332 3/4"
- 6 ★Y705566 3/4"
- 7 ★70926127 3/4"-10 X 1-3/4
- 7 ★Y705566 3/4"
- 7 ★700703923 3/4"-10
- 8 ★77057 1/4"-28 X 90°
- 9 ★700113307M ➡ 190LB-50100
- 9 ★700150608P ➡ 190LB-50101
- 10 ★6591614P
- 11 ★70925731 1/4"-28 X 65°
- 12 ★70923219 1/4"-28
- 13 ★70921703 5/8"-11 X 1-1/2
- 13 ★Y705582 5/8"
- 13 ★7704919 5/8"-11
- 14 ★70921744 1/4"-28 X 1-5/8
- 15 ★68619 1/2"-13 X 1-1/4
- 15 ★705541 1/2"
- 15 ★700714586 1/2"-13
- 16 ★70923220 3/8"-16 X 1-1/4

- | | | |
|-----------------|------------------|-------------------|
| 1 ELBOW | COUDE | WINKELSTUECK |
| | GOMITO | CODO |
| 1 TUBE | TUBE | ROHR |
| | TUBO | TUBO |
| 2 GREASE NIPPLE | GRAISSEUR DROIT | FETT-NIPPEL |
| | INGRASSAT. | ENGRASADOR |
| 1 ELBOW | COUDE | WINKELSTUECK |
| | GOMITO | CODO |
| 7 CAPSCREW | VIS BOUCHON | HUTSCHRAUBE |
| | TAPPO A VITE | TORNILLO TAPON |
| 7 WASHER | RONDELLE | UNTERLEGSCHIEBE |
| | RONDELLA | ARANDELA |
| 2 CAPSCREW | VIS BOUCHON | HUTSCHRAUBE |
| | TAPPO A VITE | TORNILLO TAPON |
| 2 LOCK WASHER | RONDELLE FREIN | FEDERRING |
| | ROSETTA DENTELL. | ARANDELA GROWER |
| 2 WASHER | RONDELLE | UNTERLEGSCHIEBE |
| | RONDELLA | ARANDELA |
| 4 CAPSCREW | VIS BOUCHON | HUTSCHRAUBE |
| | TAPPO A VITE | TORNILLO TAPON |
| 8 WASHER | RONDELLE | UNTERLEGSCHIEBE |
| | RONDELLA | ARANDELA |
| 4 LOCKNUT | ECROU BLOCAGE | SICHERUNGSMUTTER |
| | AUTOBLOCCANTE | CONTRATUERCA |
| 24 FITTING | MONTAGE | ANSCHL.VERSCHRBBG |
| | RACCORDO. | ACCESORIO. |
| 1 KNOTTER | NOUEUR | BINDER |
| | LEGATORE | ANUDADOR |
| 1 KNOTTER | NOUEUR | BINDER |
| | LEGATORE | ANUDADOR |
| 7 SPACER | ENTRETOISE | ABSTANDSTUECK |
| | DISTANZIALE | DISCO ESPACIADOR |
| 2 GREASER | GRAISSEUR | FETTNIPEL |
| | INGRASSATORE | ENGRASADOR |
| 8 GREASER | GRAISSEUR | FETTNIPEL |
| | INGRASSATORE | ENGRASADOR |
| 6 BOLT | BOULON | MASCH.SCHRAUBE |
| | BULLONE | ESPIGA/BULON |
| 6 WASHER | RONDELLE | UNTERLEGSCHIEBE |
| | RONDELLA | ARANDELA |
| 6 NUT | ECROU | MUTTER |
| | DADO | TUERCA |
| 6 GREASER | GRAISSEUR | FETTNIPEL |
| | INGRASSATORE | ENGRASADOR |
| 2 BOLT | BOULON | MASCH.SCHRAUBE |
| | BULLONE | ESPIGA/BULON |
| 2 WASHER | RONDELLE | UNTERLEGSCHIEBE |
| | RONDELLA | ARANDELA |
| 2 NUT | ECROU | MUTTER |
| | DADO | TUERCA |
| 2 BOLT | BOULON | MASCH.SCHRAUBE |
| | BULLONE | ESPIGA/BULON |

Lubrification
 Lubrification
 Schmieren
 Lubrificazione
 Engrase

50-15

Knotter
 Noueur
 Binder
 Legatore
 Anudadora

5-BA16-013-B

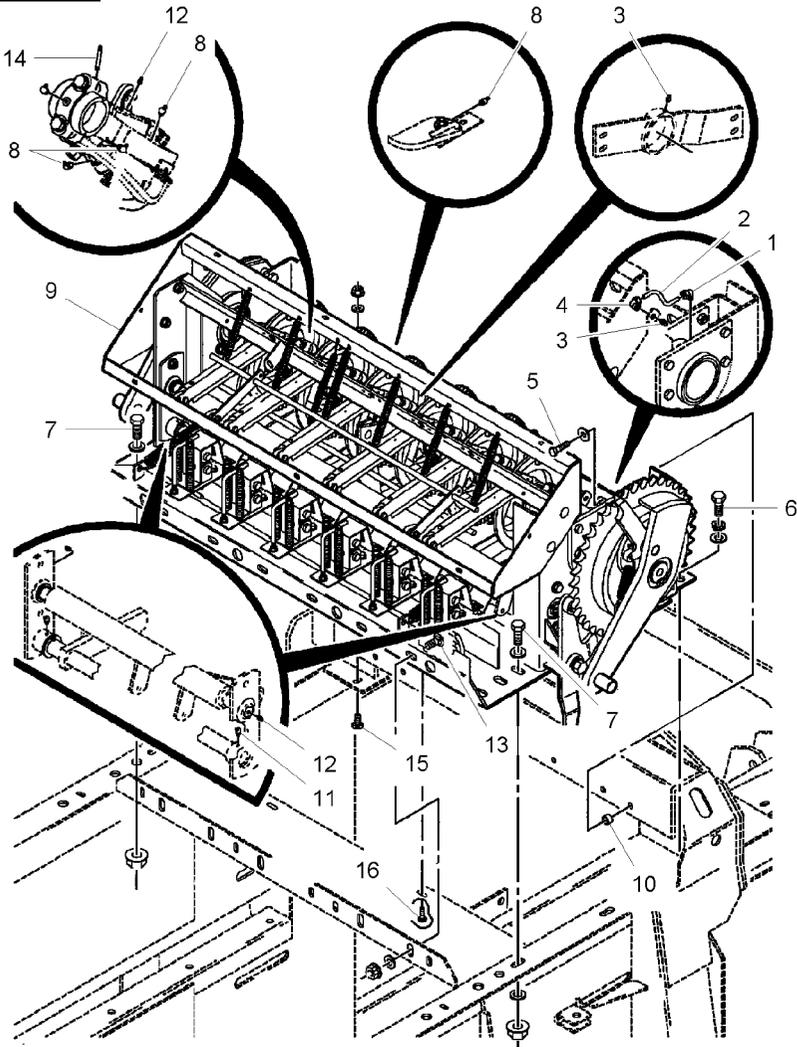

16★Y705533

3/8"

2 WASHER

RONDELLE
 RONDELLA
 ECROU BLOCCAGE
 AUTOBLOCCANTE

UNTERLEGSCHIEBE
 ARANDELA
 SICHERUNGSMUTTER
 CONTRATUERCA

16★700711238

3/8"-16

2 LOCKNUT

Frame
Chassis
Rahmen
Telaio
Bastidor

50-20

5-BA26-004-C

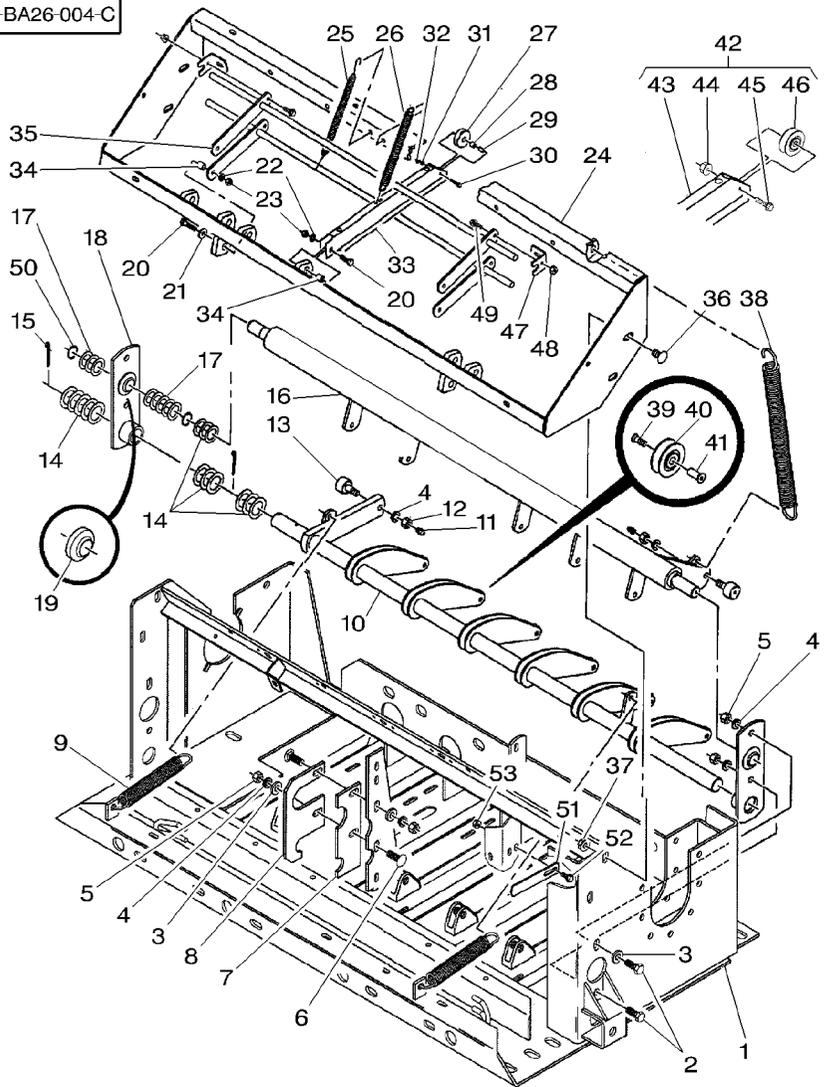

1 ★700113311	➡ HL 91399	1 FRAME	BATI	RAHMEN
1 ★700154495	➡ HL 91400	1 FRAME	CORNICE	BASTIDOR
2 ★70921176	1/2"-13 X 1-1/4	4 CAPSCREW	BATI	RAHMEN
3 705541	1/2"	4 WASHER	CORNICE	BASTIDOR
4 ★Y705046	1/2"	8 LOCK WASHER	VIS BOUCHON	HUTSCHRAUBE
5 ★704031	1/2"-13	6 NUT	TAPPO A VITE	TORNILLO TAPON
6 ★70926838	1/2"-13 X 1-1/2	2 BOLT	RONDELLE	UNTERLEGSCHIEBE
7 6845713P		1 PLATE	RONDELLA	ARANDELA
8 6845721P		1 BRACKET	RONDELLE FREIN	FEDERRING
9 858308		2 SPRING	ROSETTA DENTELL.	ARANDELA GROWER
10 700113336P		1 ARM	ECROU	MUTTER
11 70930680	3/16"	2 PIN	DADO	TUERCA
12 ★70919423	1/2"-20	2 NUT	BOULON	MASCH.SCHRAUBE
13 8050866		2 BEARING	BULLONE	ESPIGA/BULON
14 Y740068	1"-1/4 X 18	11 BUSH	PLAQUE	PLATTE
15 ★70925721	5/32" X 1-3/4	2 PIN	PIASTRA	PLATO
16 ★700113330P		1 SHAFT	SUPPORT FIXATION	HALTEAM
17 Y52209	1" X 18	11 BUSH	STAFFETTA	SOPORTE
18 700113342P		2 SUPPORT	RESSORT	FEDER
19 700706269	18	1 BALL JOINT	MOLLA	RESORTE
20 ★70921977	5/16"-18 X 1-1/4	10 CAPSCREW	BRAS	ARM
21 ★70917642	5/16"	4 WASHER	BRACCIO	BRAZO
22 ★70917356	5/16"	10 LOCK WASHER	GOUPILLE	BOLZEN
23 Y704015	5/16"-18	10 NUT	PERNO	PASADOR
24 6844971		1 BRACKET	ECROU	MUTTER
25 700712484		1 TENSION SPRING	DADO	TUERCA
			SUPPORT FIXATION	HALTEAM
			STAFFETTA	SOPORTE
			RESSORT TRACTION	ZUGFEDER
			MOLLA TENDITRICE	MUELLE TENSION

Frame
Chassis
Rahmen
Telaio
Bastidor

50-20

5-BA26-004-C

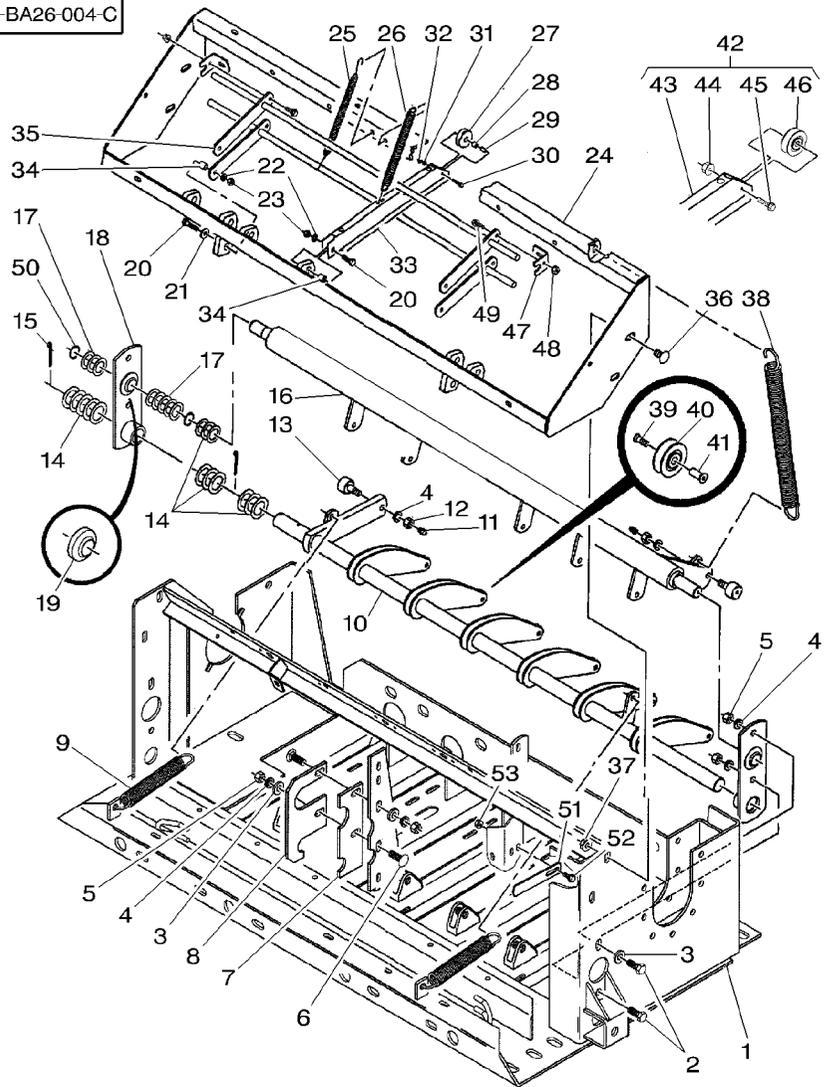

26	758482		6	TENSION SPRING	RESSORT TRACTION	ZUGFEDER
27	6529945	➔ 190LB-50214	6	ROLLER	MOLLA TENDITRICE	MUELLE TENSION
28	7849656	➔ 190LB-50214	6	SLEEVE	GALET	ROLLE
29	7849110	➔ 190LB-50214	6	BUSH	RULLO	RODILLO
30	771345	➔ 190LB-50214 No 10-24 X 1	6	CAPSCREW	MANCHON	HUELSE
31	705004	➔ 190LB-50214 No 10	6	LOCK WASHER	MANICOTTO	MANCHA
32	354120X1	➔ 190LB-50214 No 10-24	6	NUT	BAGUE	BUCHSE
33	700150609	➔ 190LB-50214	6	ARM	BOCCOLA	CASQUILLO
34	6523799		10	BUSH	VIS BOUCHON	HUTSCHRAUBE
35	700113346		2	ROD	TAPPO A VITE	TORNILLO TAPON
36	70928367	1/2"-13 X 1	4	BOLT	RONDELLE FREIN	FEDERRING
37	704254	1/2"-13	4	LOCKNUT	ROSETTA DENTELL.	ARANDELA GROWER
38	58859	➔ 190LB-50100	1	SPRING	ECROU	MUTTER
38	700714985B	➔ 190LB-50101	1	SPRING	DADO	TUERCA
39	8701476	10 No 10-32 X 1/2	6	CAPSCREW	BRAS	ARM
40	700722661	10	6	BALL BEARING	BRACCIO	BRAZO
41	866566	10 No 10-32	6	FASTENER	BAGUE	BUCHSE
42	700150609	➔ 190LB-50215	6	ARM	BOCCOLA	CASQUILLO
43	700150610P	42	6	FASTENER	TRINGLE	STANGE
44	1703354	42 1/4"-20	6	ARM	ASTA	VARILLA
45	7883283	42 1/4"-20 X 1	6	FASTENER	BOULON	MASCH.SCHRAUBE
46	700722661	42	6	ARM	BULLONE	ESPIGA/BULON
47	700153509	➔ 190LB-50215	6	ARM	ECROU BLOCAGE	SICHERUNGSMUTTER
48	7883275	➔ 190LB-50215 1/4"-20 X 3/4	6	FASTENER	AUTOBLOCCANTE	CONTRATUERCA
49	1703354	➔ 190LB-50215 1/4"-20	6	ARM	RESSORT	FEDER
50	738633		6	ARM	MOLLA	RESORTE
			6	ARM	RESSORT	FEDER
			6	ARM	MOLLA	RESORTE
			6	ARM	VIS BOUCHON	HUTSCHRAUBE
			6	ARM	TAPPO A VITE	TORNILLO TAPON
			6	ARM	ROULEMENT BILLES	KUGELLAGER
			6	ARM	CUSCINETTO SFERE	COJINETE DE BOLA
			6	ARM	AGRAFE	HALTEKLAMMER
			6	ARM	LACCIO	CIERRE
			6	ARM	BRAS	ARM
			6	ARM	BRACCIO	BRAZO
			6	ARM	BRAS	ARM
			6	ARM	BRACCIO	BRAZO
			6	ARM	ECROU	MUTTER
			6	ARM	DADO	TUERCA
			6	ARM	VIS	SCHRAUBE
			6	ARM	VITE	TORNILLO
			6	ARM	ROULEMENT BILLES	KUGELLAGER
			6	ARM	CUSCINETTO SFERE	COJINETE DE BOLA
			6	ARM	SUPPORT	LAGERUNG
			6	ARM	SUPPORTO	DISPOS.DE SOSTEN
			6	ARM	VIS	SCHRAUBE
			6	ARM	VITE	TORNILLO
			6	ARM	ECROU	MUTTER
			6	ARM	DADO	TUERCA
			6	ARM	ANNEAU	RING
			6	ARM	ANELLO	ARO

Frame
Chassis
Rahmen
Telaio
Bastidor

50-20

5-BA26-004-C

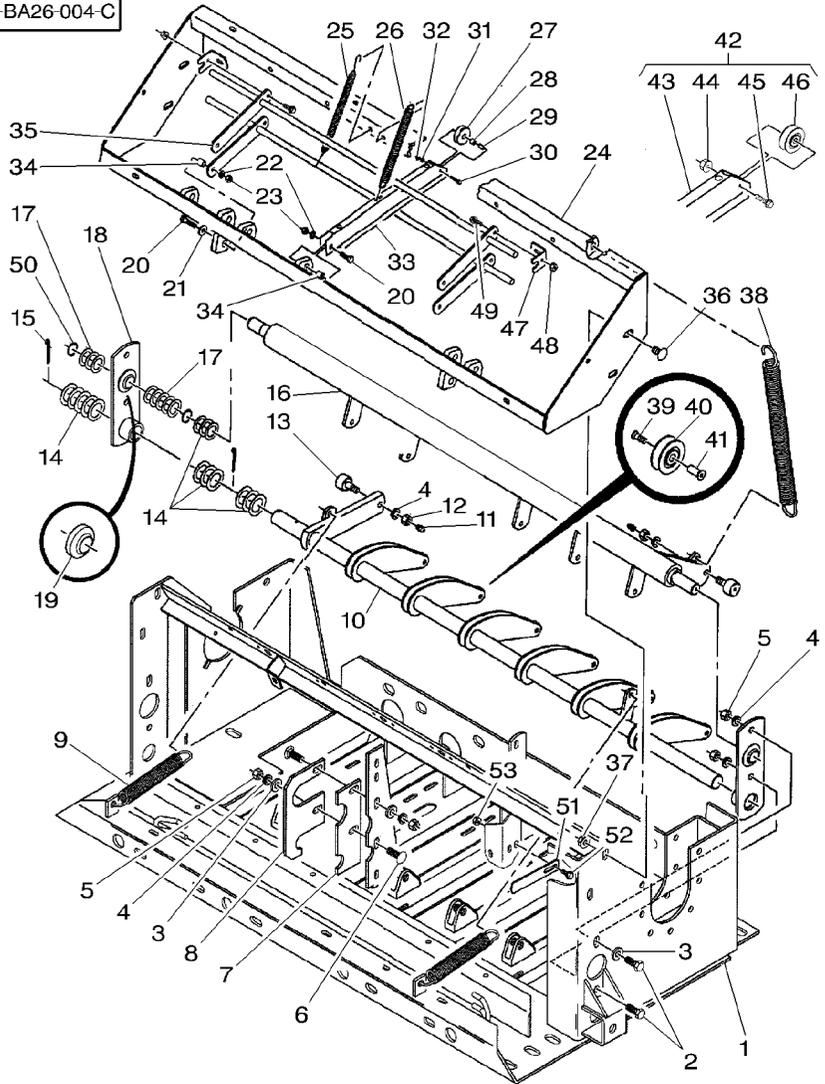

51 700153514

➡ 190LB-50215

1 STRAP

PATTE
CORREGGIA

LASCHE
FAJA

52 7883325

➡ 190LB-50215
5/16"-18 X 3/4

2 SCREW

VIS
VITE

SCHRAUBE
TORNILLO

53 Y704726

➡ 190LB-50215
5/16"-18

2 LOCKNUT

ECROU BLOCCAGE
AUTOBLOCCANTE

SICHERUNGSMUTTER
CONTRATUERCA

Knotter Control
 Commande Des Noueurs
 Binderantrieb
 Comando Legatore
 Mando Del Anudadora

Cam Assembly
 Ensemble Came
 Nocken Kpl
 Cammacomplet
 Levacjct

50-25

5 BA38 002 A

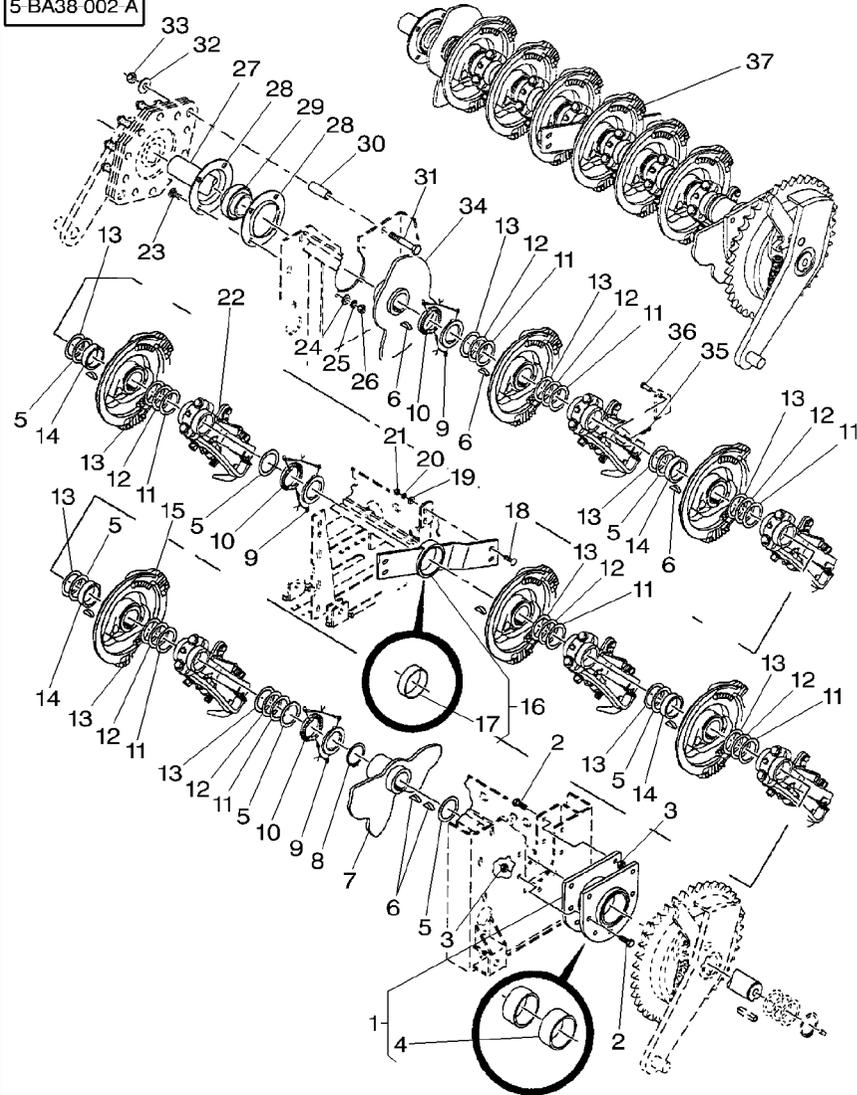

1	6844773P		1	BRACKET	SUPPORT FIXATION	HALTEAM
2	★70921176	1/2"-13 X 1-1/4	13	CAPSCREW	STAFFETTA	SOPORTE
3	Y704288	1/2"-13	13	LOCKNUT	VIS BOUCHON	HUTSCHRAUBE
4	6565014	1	2	BEARING	TAPPO A VITE	TORNILLO TAPON
5	6523500		13	LOCKNUT	ECROU BLOCCAGE	SICHERUNGSMUTTER
6	70910851	3/8" X 1-1/2	2	BEARING	AUTOBLOCCANTE	CONTRATUERCA
7	700113328P		7	BUSH	COUSSINET	LAGER
8	355919X1		9	KEY	CUSCINETTO	COJINETE
9	8701484	No 10 X 1/2	1	CAM	BAGUE	BUCHSE
10	6591457		6	SHIM	BOCCOLA	CASQUILLO
11	Y6613665	∆ .005	1	SNAPRING	CLAVETTE	PASSKEIL
12	6523534		1	CAM	CHIAVETTA	CLAVE
13	6523542	∆ .031	1	CAM	CAME	NOCKEN
14	6591549P		1	SNAPRING	CAMMA	LEVA
15	700138856P		1	SNAPRING	SEGMENT ARRET	SPRENGRING
16	★6591465		12	SCREW	ANELLO SIEGER	ANILLA RETENCION
17	6591564	16	6	SHIM	VIS	SCHRAUBE
18	★70923220	3/8"-16 X 1-1/4	6	SHIM	VITE	TORNILLO
19	Y705533	3/8"	6	SHIM	CALE REGLAGE	EINSTELLBLECH
20	★70916965	3/8"	16	SHIM	SPESSORE	CALCE
21	★70916950	3/8"-16	16	SHIM	CALE REGLAGE	EINSTELLBLECH
22	★700113321P	50-30 No 1 50-35 No 1	18	SHIM	SPESSORE	CALCE
23	★68619	1/2"-13 X 1-1/4	16	SHIM	CALE REGLAGE	EINSTELLBLECH
24	705541	1/2"	16	SPACER	SPESSORE	CALCE
25	★Y705046	1/2"	6	GEAR	ENTRETOISE	ABSTANDSTUECK
26	★704031	1/2"-13	6	GEAR	DISTANZIALE	DISCO ESPACIADOR
			1	BRACKET	INGRENAGE	ZAHNRAD
			1	BRACKET	INGRANAGGIO	ENGRANAJE
			1	BRACKET	SUPPORT FIXATION	HALTEAM
			1	BUSH	STAFFETTA	SOPORTE
			4	BOLT	BAGUE	BUCHSE
			4	WASHER	BOCCOLA	CASQUILLO
			4	LOCK WASHER	BOULON	MASCH.SCHRAUBE
			4	NUT	BULLONE	ESPIGA/BULON
			4	NUT	RONDELLE	UNTERLEGSCHIEBE
			4	NUT	RONDELLA	ARANDELA
			4	NUT	RONDELLE FREIN	FEDERRING
			4	NUT	ROSETTA DENTELL.	ARANDELA GROWER
			4	NUT	ECROU	MUTTER
			4	NUT	DADO	TUERCA
			4	NUT	DADO	TUERCA

Knotter Control
 Commande Des Noueurs
 Binderantrieb
 Comando Legatore
 Mando Del Anudadora

Cam Assembly
 Ensemble Came
 Nocken Kpl
 Cammacomplet
 Levacjt

50-25

5 BA38 002 A

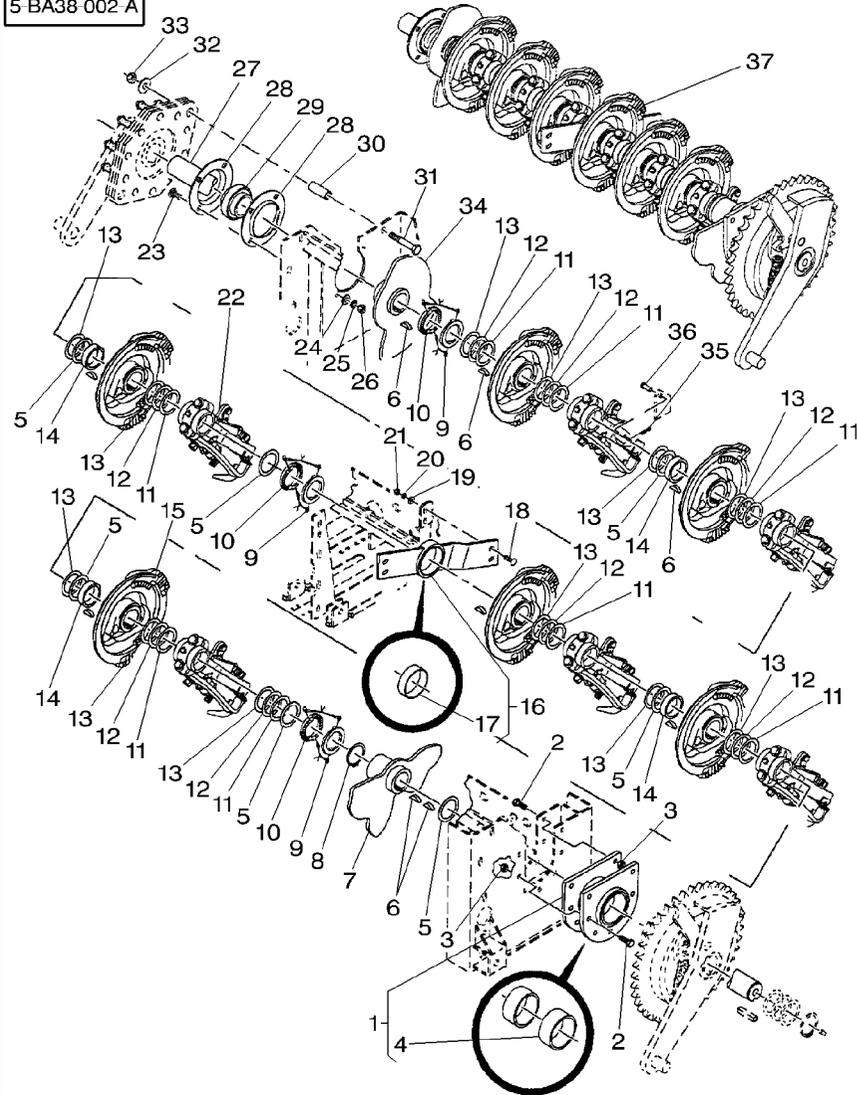

27 6591366

28 714360

29 8050478

30 235663

31 70924136

31 ★70923501

32 ★70918432

33 7774482

34 ★700113325

35 98-2107

36 63586

37 700113310

37 700134407

➡ 190LB-50100
 5/8"-11 X 3-3/4

➡ 190LB-50101
 5/8"-11 X 3-3/4
 5/8"

5/8"-11

.149

3/8" X 1-1/8

➡ 190LB-50100

➡ 190LB-50101

1 SHAFT

2 FLANGE

1 BEARING

2 BUSH

2 CAPSCREW

2 CAPSCREW

2 WASHER

2 LOCKNUT

1 CAM

1 PIN

1 CLEVIS PIN

1 KNOTTER

1 KNOTTER

ARBRE

ALBERO

FLASQUE

FLANGIA

COUSSINET

CUSCINETTO

BAGUE

BOCCOLA

VIS BOUCHON

TAPPO A VITE

VIS BOUCHON

TAPPO A VITE

RONDELLE

RONDELLA

ECROU BLOCAGE

AUTOBLOCCANTE

CAME

CAMMA

GOUPILLE

PERNO

PERNO D'ATTACCO

NOUEUR

LEGATORE

NOUEUR

LEGATORE

WELLE

ARBOL

FLANSCH

PLETINA

LAGER

COJINETE

BUCHSE

CASQUILLO

HUTSCHRAUBE

TORNILLO TAPON

HUTSCHRAUBE

TORNILLO TAPON

UNTERLEGSCHIEBE

ARANDELA

SICHERUNGSMUTTER

CONTRATUERCA

NOCKEN

LEVA

BOLZEN

PASADOR

SPLINTBOLZEN

BULON CILINDRICO

BINDER

ANUDADOR

BINDER

ANUDADOR

Knotter
 Noueur
 Binder
 Legatore
 Anudadora

50-30

5-BA06-006-C

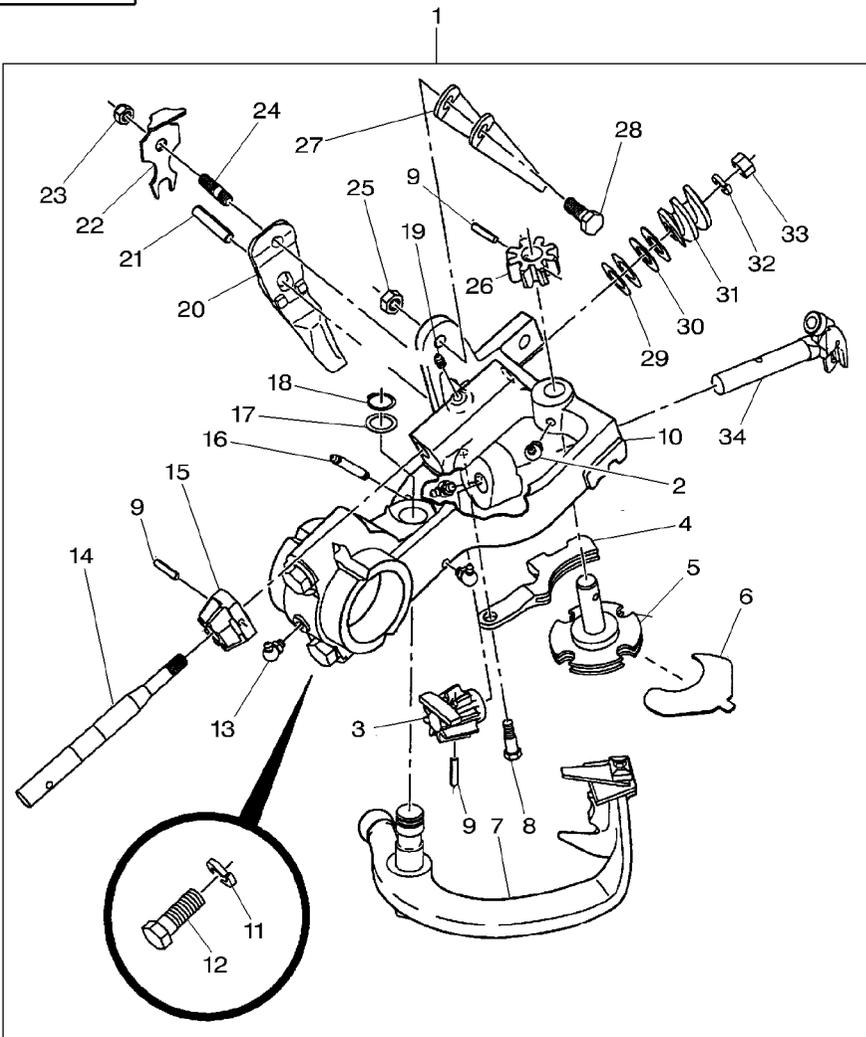

1	700113321P		1	HEAD	TETE	KOPF
2	77057	1 1/4"-28 X 90	1	FITTING	TESTA	CULATA
3	7894389	1	1	BEVEL GEAR	MONTAGE	ANSCHL.VERSCHRBG
4	8045148	1	1	HOLDER	RACCORDO.	ACCESORIO.
5	1712868	1	1	DISC	COURONNE CONIQUE	KEGELRAD
6	6523807	1	1	PLATE	COPPIA CONICA	ENGRANAJE CONICO
7	700138858	1	1	STRIPPER	PIECE SUPPORT	HALTER
8	702400022	1 5/16"-18	1	SCREW	SUPPORTO DI BASE	SUJETADOR
9	70922598	1 3/16" X 7/8	3	PIN	DISQUE	SCHEIBE
10	700138857	1	1	FRAME	DISCO	DISCO
11	Y705046	10 1/2"	2	LOCK WASHER	PLAQUE	PLATTE
12	70921024	10 1/2"-13 X 2	2	CAPSCREW	PIASTRA	PLATO
13	77057	1 1/4"-28 X 90	3	FITTING	DEBOURREUR	ABSTREIFER
14	6553267	1	1	SHAFT	SPOGLIATORE	DESBARBADOR
15	702700040	1	1	PINION	VIS	SCHRAUBE
16	70921744	1 1/4"-28 X 1-5/8	1	GREASER	VITE	TORNILLO
17	7852742	1 25/32"	1	BUSH	GOUPILLE	BOLZEN
18	70927732	1	1	SNAPRING	PERNO	PASADOR
19	70923219	1 1/4"-28	1	GREASER	BATI	RAHMEN
20	700113323P	1	1	CAM	CORNICE	BASTIDOR
21	70922135	1 5/16" X 1	1	PIN	RONDELLE FREIN	FEDERRING
22	7895733	1	1	TENSIONER	ROSETTA DENTELL.	ARANDELA GROWER
23	704486	1 5/16"-18	1	NUT	VIS BOUCHON	HUTSCHRAUBE
24	6523229	1	1	STUD	TAPPO A VITE	TORNILLO TAPON
25	70917421	1 3/8"-16	1	NUT	RACCORDO.	ANSCHL.VERSCHRBG
26	7894454	1	1	GEAR	ARBRE	WELLE
					ALBERO	ARBOL
					PIGNON	RITZEL
					PIGNONE	PINON
					GRAISSEUR	FETTNIPEL
					INGRASSATORE	ENGRASADOR
					BAGUE	BUCHSE
					BOCCOLA	CASQUILLO
					SEGMENT ARRET	SPRENGRING
					ANELLO SIEGER	ANILLA RETENCION
					GRAISSEUR	FETTNIPEL
					INGRASSATORE	ENGRASADOR
					CAME	NOCKEN
					CAMMA	LEVA
					GOUPILLE	BOLZEN
					PERNO	PASADOR
					TENDEUR	SPANNER
					TENDITORE	TENSOR
					ECROU	MUTTER
					DADO	TUERCA
					GOUJON	STEBBOLZEN
					PRIGIONIERO	CHAVETA ROSCADO
					ECROU	MUTTER
					DADO	TUERCA
					ENGRENAGE	ZAHNRAD
					INGRANAGGIO	ENGRANAJE

Knotter
 Noueur
 Binder
 Legatore
 Anudadora

50-30

5-BA06-006-C

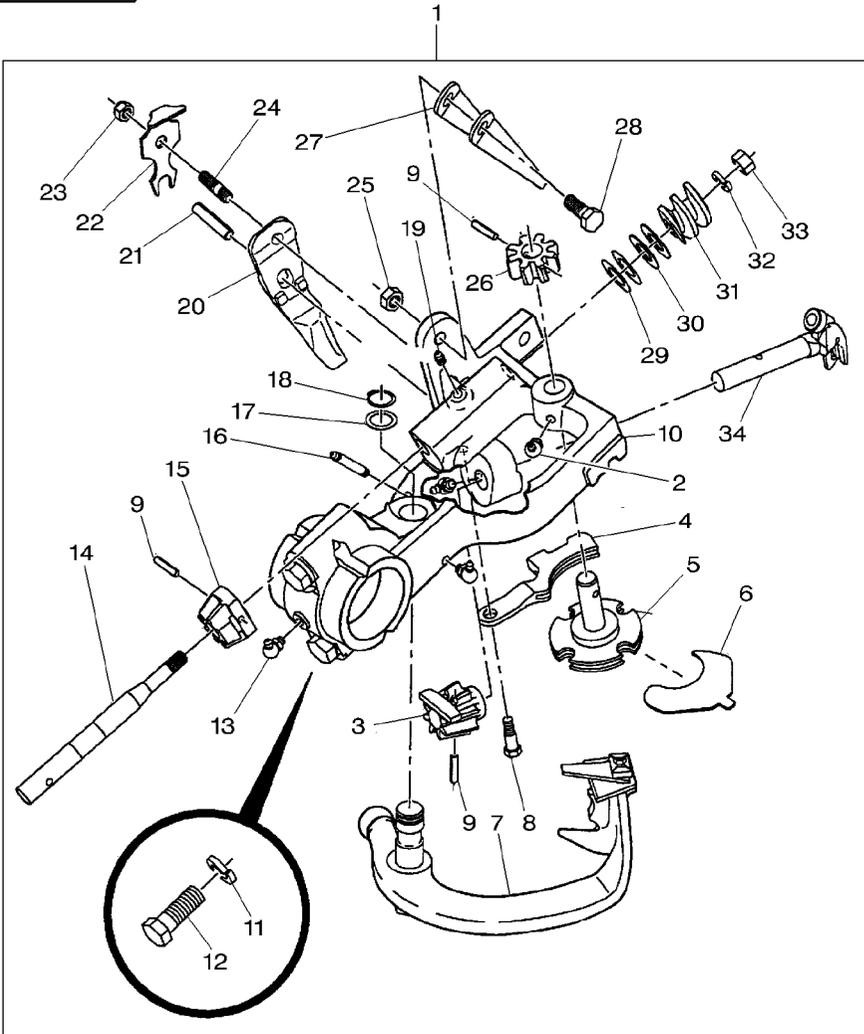

27	6553259P	1	2	SPRING	RESSORT	FEDER
28	★70921210	1	1	3/8"-16 X 1	MOLLA	RESORTE
29	6553275	1	1	CAPSCREW	VIS BOUCHON	HUTSCHRAUBE
30	7852163	1	2	SHIM	TAPPO A VITE	TORNILLO TAPON
31	7894413	1	2	BUSH	CALE REGLAGE	EINSTELLBLECH
32	★70916965	1	1	WORM GEAR	SPESSORE	CALCE
33	★70923434	1	2	BUSH	BAGUE	BUCHSE
34	700700968	1	1	LOCK WASHER	BOCCOLA	CASQUILLO
			1	NUT	PIGNON HELICOIDA	SCHNECKENRAD
			1	KNOTTER	INGRANAGGIO ELIC	ENGRANAJE SINFIN
					RONDELLE FREIN	FEDERRING
					ROSETTA DENTELL.	ARANDELA GROWER
					ECROU	MUTTER
					DADO	TUERCA
					NOUEUR	BINDER
					LEGATORE	ANUDADOR

Knotter
 Noueur
 Binder
 Legatore
 Anudadora

50-35

5-BA06-002-B

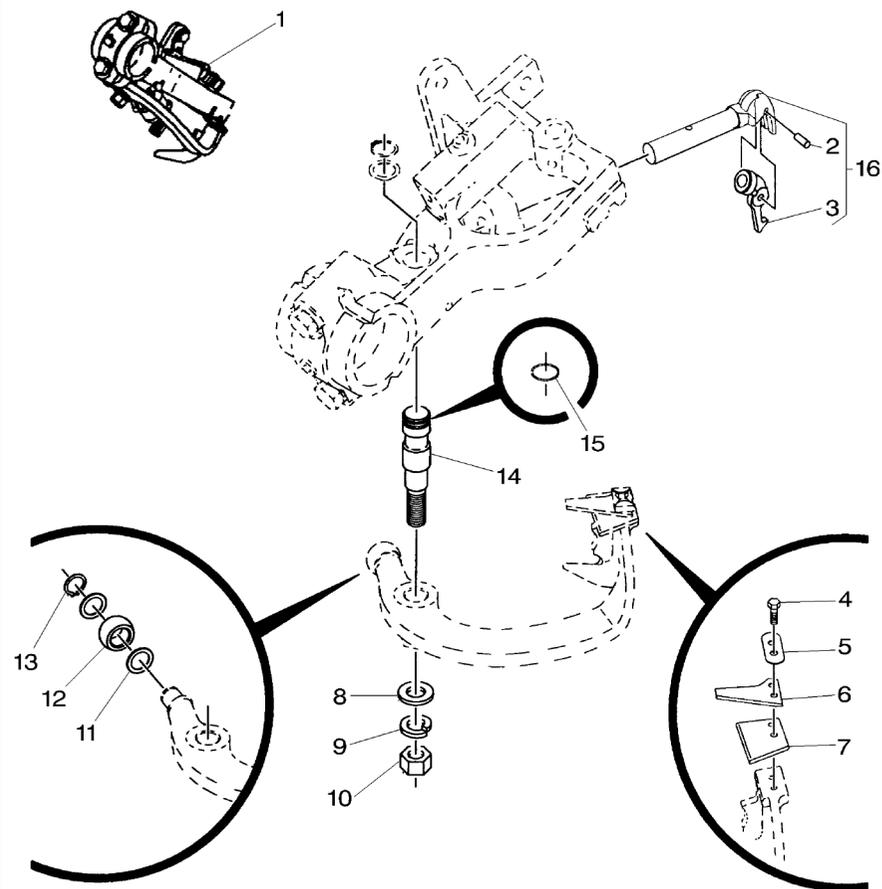

1	★700113321P	1	HEAD	TETE	KOPF
2	863738	16	3/16" X 1/2	TESTA	CULATA
3	1712835	16		PLOT	ZYLINDERSTIFT
4	8701625	1	No 10-32 X 1/2	SPINA	CENTRAJE
5	6613624P	1		CROCHET	HAKEN
6	700715627	1	➔ 22-07-98	GANCIO	GANCHO
6	700718710	1	➔ 23-07-98 ⚡ 1,5 MM	VIS	SCHRAUBE
7	700102136	1		VITE	TORNILLO
8	6591572	1		PLAQUE BLOCAGE	SICH.BLECH
9	★Y705046	1	1/2"	PIASTRA DI FERMO	PLACA DE BLOCAJE
10	★70919423	1	1/2"-20	COUTEAU	MESSER
11	7852593	1	9/16" X 20	COLTELLO	CUCHILLA
12	700122799	1		COUTEAU	MESSER
13	70927728	1		COLTELLO	CUCHILLA
14	6591580	1		SEMELLE	FUSSPLATTE
15	70923561	14		BASE	BASE
16	700700968	1		BASE	BASE
				RONDELLE	UNTERLEGSSCHEIBE
				RONDELLA	ARANDELA
				RONDELLE FREIN	FEDERRING
				ROSETTA DENTELL.	ARANDELA GROWER
				ECROU	MUTTER
				DADO	TUERCA
				BAGUE	BUCHSE
				BOCCOLA	CASQUILLO
				GALET	ROLLE
				RULLO	RODILLO
				SEGMENT ARRET	SPRENGRING
				ANELLO SIEGER	ANILLA RETENCION
				ARBRE	WELLE
				ALBERO	ARBOL
				JOINT TORIQUE	O-RING
				ANELLO TENUTA	ANILLO FORMA 'O'
				NOUEUR	BINDER
				LEGATORE	ANUDADOR

Hay Check
Reteneur Escamotable
Pressgut-Rueckhalter
Controllo Fieno
Control

50-40

5-BA30-002-B

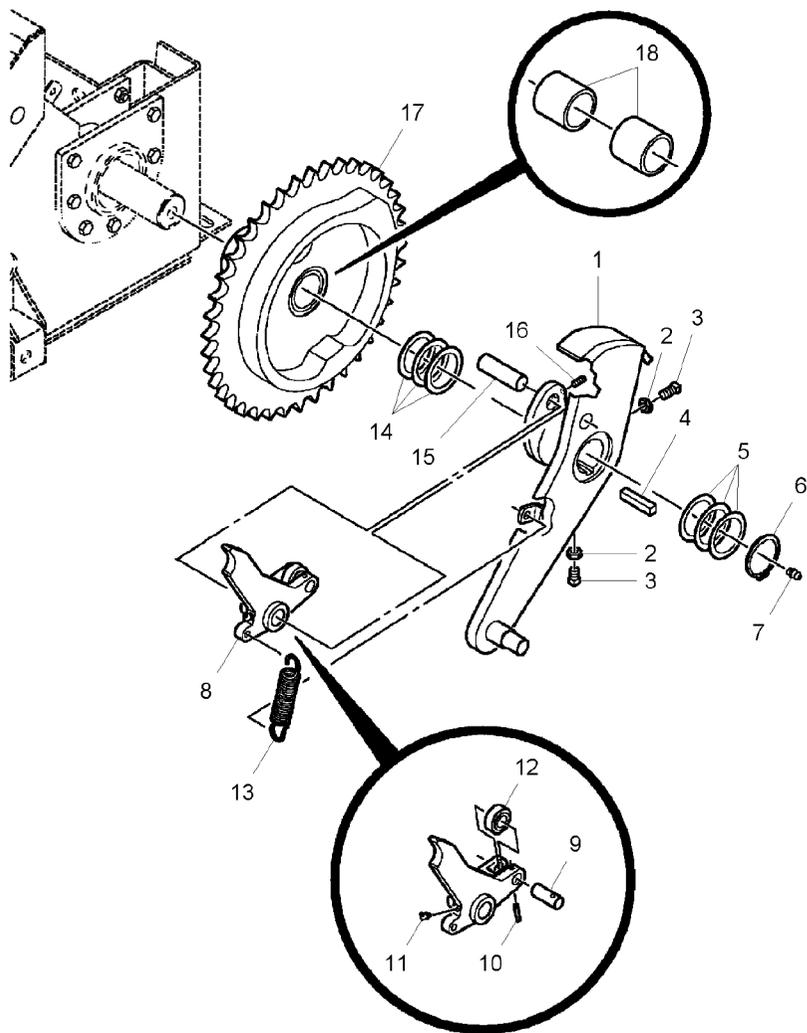

1	★6845598	➡ 09-DEC-1997	1	ARM	BRAS	ARM
1	★700134414P	➡ 10-DEC-1997	1	ARM	BRACCIO	BRAZO
2	★700710414	1/2"-13	2	NUT	BRAS	ARM
3	★70923306	➡ ...	2	SETSCREW	BRACCIO	BRAZO
3	★70922695	1/2"-13 X 1	2	SETSCREW	ECROU	MUTTER
4	★Y61879	➡ ...	2	SETSCREW	DADO	TUERCA
5	★6523534	1/2"-13 X 1-1/4	1	KEY	VIS DE BLOCAGE	STELLSCHRAUBE
6	★355919X1	1/2X1/2 X 2-1/2	2	SETSCREW	INSIEME VITI	SET SCREW
7	★70914465	1/8"-27	1	KEY	VIS DE BLOCAGE	STELLSCHRAUBE
8	★700124052P		1	SHIM	INSIEME VITI	SET SCREW
9	★6524649P	8	3	SHIM	CLAVETTE	PASSKEIL
10	★763987	8 1/4" X 1-1/4	1	SNAPRING	CHIAVETTA	CLAVE
11	★70925731	8 1/4"-28 X 65°	1	GREASER	CALE REGLAGE	EINSTELLBLECH
12	★6524623P	8	1	GREASE NIPPLE	SPESSORE	CALCE
13	★758268		1	ARM	SEGMENT ARRET	SPRENGRING
14	★6523500		1	ARM	ANELLO SIEGER	ANILLA RETENCION
15	★6523518		1	SHAFT	GRAISSEUR DROIT	FETT-NIPPEL
16	★Y708230	5/16"-18 X 3/4	1	SHAFT	INGRASSAT.	ENGRASADOR
17	★700113329	➡ 09-DEC-1997	1	PIN	BRAS	ARM
17	★700137486P	➡ 10-DEC-1997	1	GREASER	BRACCIO	BRAZO
18	★700122883	17	1	ROLLER	ARBRE	WELLE
			1	TENSION SPRING	ALBERO	ARBOL
			3	BUSH	GOUILLE	BOLZEN
			1	SHAFT	PERNO	PASADOR
			1	SETSCREW	GRAISSEUR	FETTNIPEL
			1	SPROCKET	INGRASSATORE	ENGRASADOR
			1	SPROCKET	GALET	ROLLE
			1	BEARING	RULLO	RODILLO
					RESSORT TRACTION	ZUGFEDER
					MOLLA TENDITRICE	MUELLE TENSION
					BAGUE	BUCHSE
					BOCCOLA	CASQUILLO
					ARBRE	WELLE
					ALBERO	ARBOL
					VIS DE BLOCAGE	STELLSCHRAUBE
					INSIEME VITI	SET SCREW
					BARBOTIN	KETTENRAD
					RUOTA MOTRICE	RUEDA DE CADENA
					BARBOTIN	KETTENRAD
					RUOTA MOTRICE	RUEDA DE CADENA
					COUSSINET	LAGER
					CUSCINETTO	COJINETE

Knotter
 Noueur
 Binder
 Legatore
 Anudadora

50-45

Brakes
 Frein
 Bremse
 Freni
 Freno

5-BA06-011-B

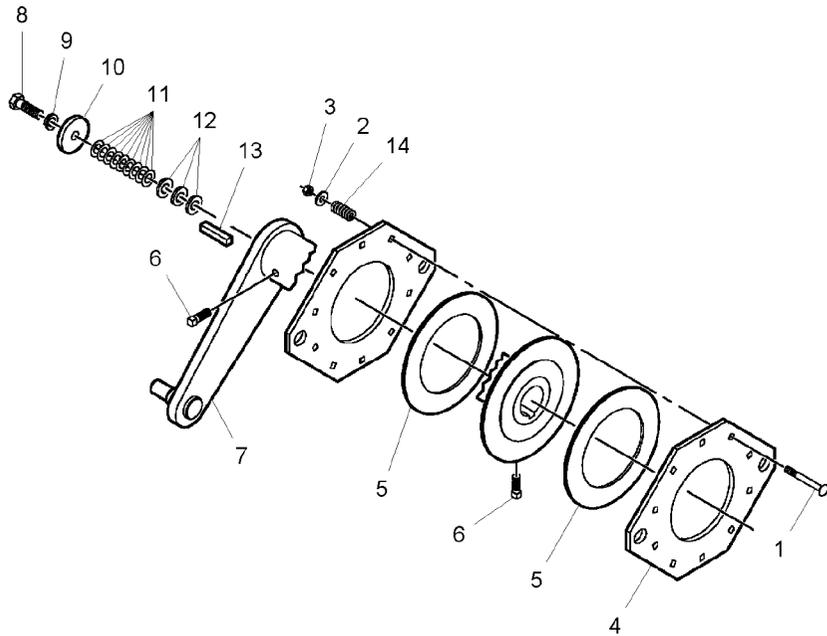

1 ★70931359	3/8" - 16 X 3-1/2	10 BOLT	BOULON	MASCH.SCHRAUBE
2 ★70917378	3/8"	10 FLAT WASHERS	BULLONE	ESPIGA/BULON
3 ★70919439	3/8" - 16	10 NUT	RONDELLES PLATES	UNTERLEGSCHIEBEN
4 ★6818561		2 PLATE	RONDELLE PIANA	ARANDELAS PLANAS
5 ★700710946		2 CLUTCH DISC	ECROU	MUTTER
6 ★70923056	➡ ...	1 SETSCREW	DADO	TUERCA
6 ★70922695	➡ ...	2 SETSCREW	PLAQUE	PLATE
7 ★6818546	➡ 190LB-50100	1 ARM	PIASTRA	PLATO
7 ★700134409P	➡ 190LB-50101	1 ARM	DISQUE EMBRAYAGE	KUPPLUNGSSCHIEBE
8 ★70922664	5/8" - 11 X 2	1 CAPSCREW	DISCO FRIZIONE	DISCO DE EMBRAGU
9 ★70917373	5/8"	1 LOCK WASHER	VIS DE BLOCAGE	STELLSCHRAUBE
10 ★6561351P		1 CAP	INSIEME VITI	SET SCREW
11 ★6553275		9 SHIM	VIS DE BLOCAGE	STELLSCHRAUBE
12 ★Y705582	5/8"	3 WASHER	INSIEME VITI	SET SCREW
13 ★Y61879	1/2 X 1/2 X 2-1/2	1 KEY	BRAS	ARM
14 ★58644		10 SPRING	BRACCIO	BRAZCO
			BRAS	ARM
			BRACCIO	BRAZO
			VIS BOUCHON	HUTSCHRAUBE
			TAPPO A VITE	TORNILLO TAPON
			RONDELLE FREIN	FEDERRING
			ROSETTA DENTELL.	ARANDELA GROWER
			CHAPEAU	KAPPE
			CAPUCHON	TAPA
			CALE REGLAGE	EINSTELLBLECH
			SPESSORE	CALCE
			RONDELLE	UNTERLEGSCHIEBE
			RONDELLA	ARANDELA
			CLAVETTE	PASSKEIL
			CHIAVETTA	CLAVE
			RESSORT	FEDER
			MOLLA	RESORTE

Knotter Control
 Commande Des Noueurs
 Binderantrieb
 Comando Legatore
 Mando Del Anudadora

Frame
 Bati
 Rahmen
 Telaio
 Bastidor

50-50

➔ HM 91616

5-BA37-002-B

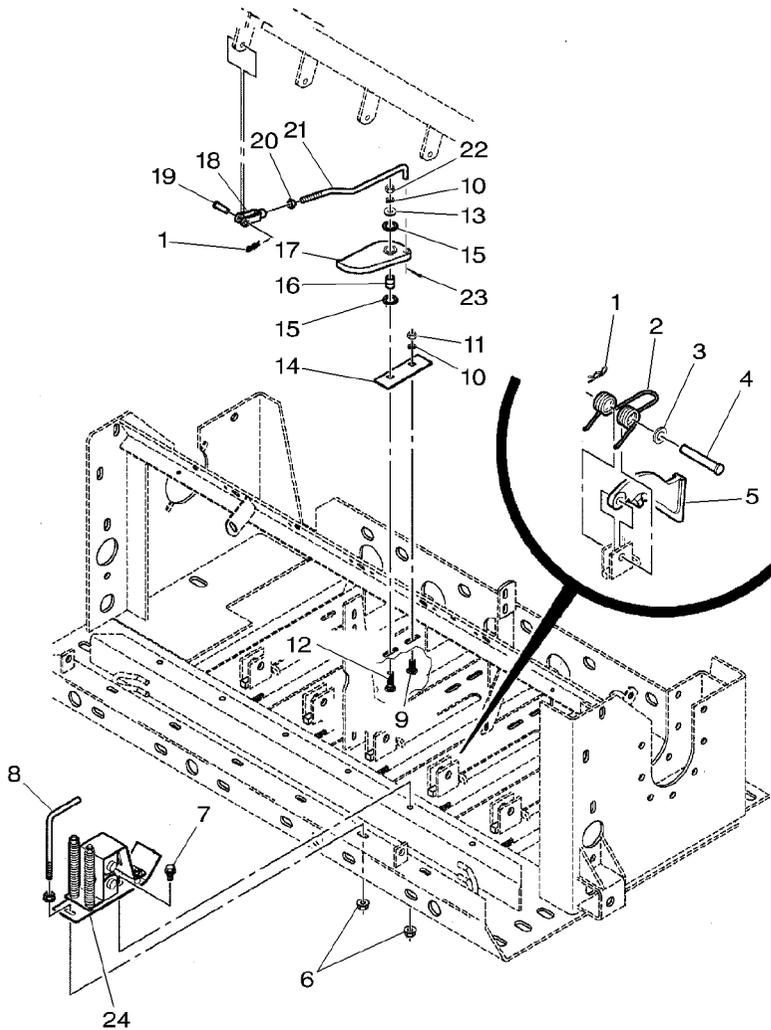

1	98-2107		11	PIN	GOUPILLE	BOLZEN
2	★700706376B			5	SPRING	PASADOR
3	Y705582	5/8"			RESSORT	FEDER
4	700706685	5/8" X 3-3/4			MOLLA	RESORTE
5	700137655P			5	WASHER	UNTERLEGSSCHEIBE
					RONDELLE	ARANDELA
					RONDELLA	SPLINTBOLZEN
					AXE	BULON CILINDRICO
					PERNO D'ATTACCO	KLAUE
					CHIEN	PRISIONERO
					CANE	MUTTER
6	704247	3/8"-16		18	NUT	TUERCA
					ECROU	HUTSCHRAUBE
					DADO	TORNILLO TAPON
7	7703432	3/8"-16 X 3/4		6	CAPSCREW	STANGE
					VIS BOUCHON	VARILLA
					TAPPO A VITE	MASCH.SCHRAUBE
8	702400048			6	ROD	ESPIGA/BULON
					ASTA	FEDERRING
9	70922786	3/8"-16 X 1		6	BOLT	ARANDELA GROWER
					BOULON	MUTTER
10	★70916965	3/8"		18	LOCK WASHER	TUERCA
					RONDELLE FREIN	MASCH.SCHRAUBE
11	★70916950	3/8"-16		6	NUT	ESPIGA/BULON
					ECROU	UNTERLEGSSCHEIBEN
12	★768036	3/8"-16 X 1-1/2		6	BOLT	ARANDELAS PLANAS
					BOULON	HALTEAMM
13	★70917378	3/8"		6	FLAT WASHERS	SOPORTE
					BULLONE	DICHTRING
14	6523617P			6	BRACKET	ARENDELA D'JUNTA
					RONDELLES PLATES	BUCHSE
15	8044695				RONDELLE PIANA	CASQUILLO
					SUPPORT FIXATION	FINGER
16	700122681P			12	SEAL	DEDO
					ANETTO RACCORD	GELENKGABEL
17	700113345P			6	BUSH	YUGO
					BAGUE	SPLINTBOLZEN
18	70924121	3/8"-24		6	FINGER	BULON CILINDRICO
					DOIGT	MUTTER
19	63586	3/8" X 1-1/8			DITO	TUERCA
					CHAPE ARTICULAT	STANGE
20	70918403	3/8"-24		6	YOKE	VARILLA
					FORCELLA	MUTTER
21	6523740P				AXE	TUERCA
					PERNO D'ATTACCO	STANGE
22	70917421	3/8"-16		6	NUT	VARILLA
					ECROU	MUTTER
23	354057X1	1/8" X 3/4		6	ROD	TUERCA
					DADO	STANGE
24	★6845077P	50-85 No 1		12	SPLIT PIN	VARILLA
					GOUPILLE FENDUE	MUTTER
					COPIGLIA	TUERCA
					TENDEUR	SPALTBOLZEN
					TENDITORE	PASADOR HENDIDO
						SPANNER
						TENSOR

Knotter Control
 Commande Des Noueurs
 Binderantrieb
 Comando Legatore
 Mando Del Anudadora

Frame
 Bati
 Rahmen
 Telaio
 Bastidor

50-55

➔ HM 91617

5-BA37-009-A

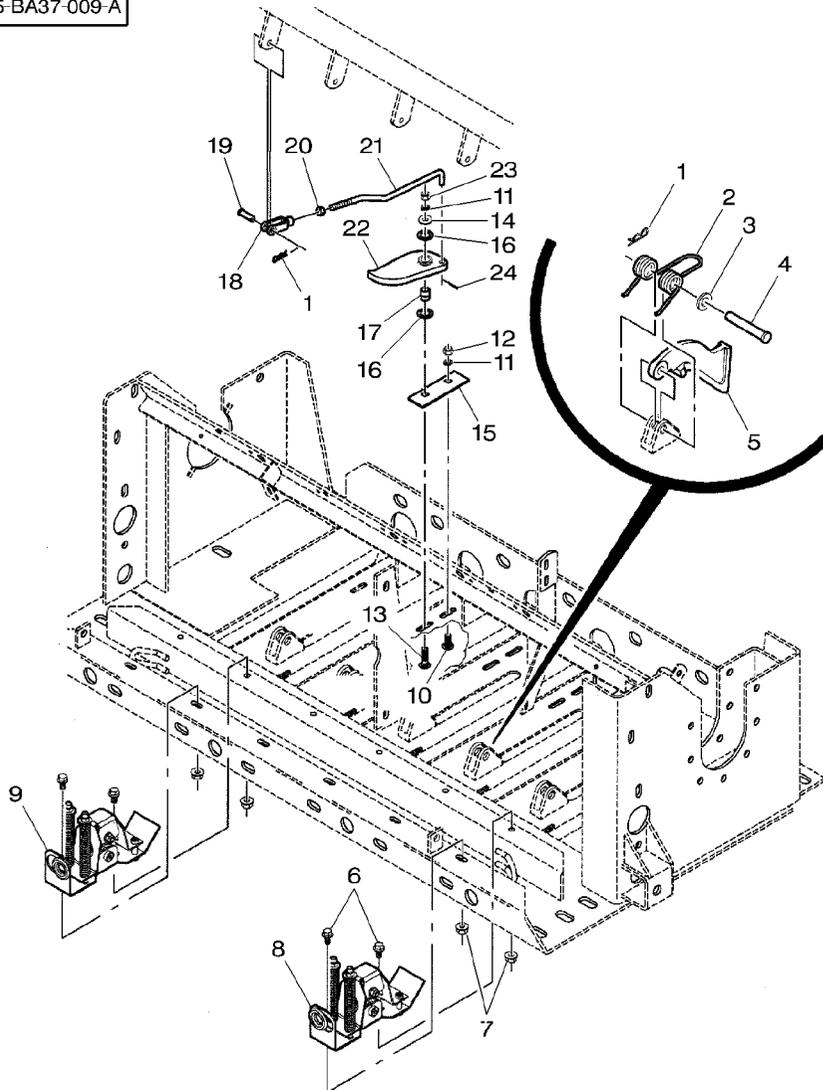

1	98-2107		11	PIN	GOUPILLE	BOLZEN
2	★700706376B				PERNO	PASADOR
3	Y705582	5/8"	5	SPRING	RESSORT	FEDER
4	700706685	5/8" X 3-3/4			MOLLA	RESORTE
5	700137655P		5	WASHER	RONDELLE	UNTERLEGSCHIEBE
6	7703432	3/8"-16 X 3/4			RONDELLE	ARANDELA
7	704247	3/8"-16	5	CLEVIS PIN	AXE	SPLINTBOLZEN
8	★700139338	👁 50-90 No 1			PERNO D'ATTACCO	BULON CILINDRICO
9	★700139336	👁 50-90 No 1	5	DOG	CHIEN	KLAUE
10	70922786	3/8"-16 X 1			CANE	PRISIONERO
11	★70916965	3/8"	12	CAPSCREW	VIS BOUCHON	HUTSCHRAUBE
12	★70916950	3/8"-16			TAPPO A VITE	TORNILLO TAPON
13	★768036	3/8"-16 X 1-1/2	12	NUT	ECROU	MUTTER
14	★70917378	3/8"			DADO	TUERCA
15	6523617P		3	TENSIONER	TENDEUR	SPANNER
16	8044695				TENDITORE	TENSOR
17	700122681P		3	TENSIONER	TENDEUR	SPANNER
18	70924121	3/8"-24			TENDITORE	TENSOR
19	63586	3/8" X 1-1/8	6	BOLT	BOULON	MASCH.SCHRAUBE
20	70918403	3/8"-24			BULLONE	ESPIGA/BULON
21	6523740P		12	LOCK WASHER	RONDELLE FREIN	FEDERRING
22	700113345P		6	NUT	ROSETTA DENTELL.	ARANDELA GROWER
23	★Y704635	3/8"-16			ECROU	MUTTER
24	★70918451	1/8" X 3/4	6	BOLT	DADO	TUERCA
					BOULON	MASCH.SCHRAUBE
			6	FLAT WASHERS	BULLONE	ESPIGA/BULON
					RONDELLES PLATES	UNTERLEGSCHIEBEN
			6	BRACKET	RONDELLE PIANA	ARANDELAS PLANAS
					SUPPORT FIXATION	HALTEAM
			12	SEAL	STAFFETTA	SOPORTE
					JOINT ETANCHEITE	DICHRING
			6	BUSH	ANELLO RACCORD	ARENDELA D'JUNTA
					BAGUE	BUCHSE
			6	YOKE	BOCCOLA	CASQUILLO
					CHAPE ARTICULAT	GELENKGABEL
			6	CLEVIS PIN	FORCELLA	YUGO
					AXE	SPLINTBOLZEN
			6	NUT	PERNO D'ATTACCO	BULON CILINDRICO
					ECROU	MUTTER
			6	ROD	DADO	TUERCA
					TRINGLE	STANGE
			6	FINGER	ASTA	VARILLA
					DOIGT	FINGER
			6	LOCKNUT	DITO	DEDO
					ECROU BLOCAGE	SICHERUNGSMUTTER
			12	PIN	AUTOBLOCCANTE	CONTRATUERCA
					GOUPILLE	BOLZEN
					PERNO	PASADOR

Knotter
 Noueur
 Binder
 Legatore
 Anudadora

50-60

Tension Adjusting - Up To 190lb-50146
 Reglage De Tension - Jusqu' Au 190lb-50146
 Spannungregler - Bis 190lb-50146
 Regitro Della Tensione - Fino All 190lb-50146
 Reguladora De La Tension - Hasta 190lb-50146

5-BA06-007-C

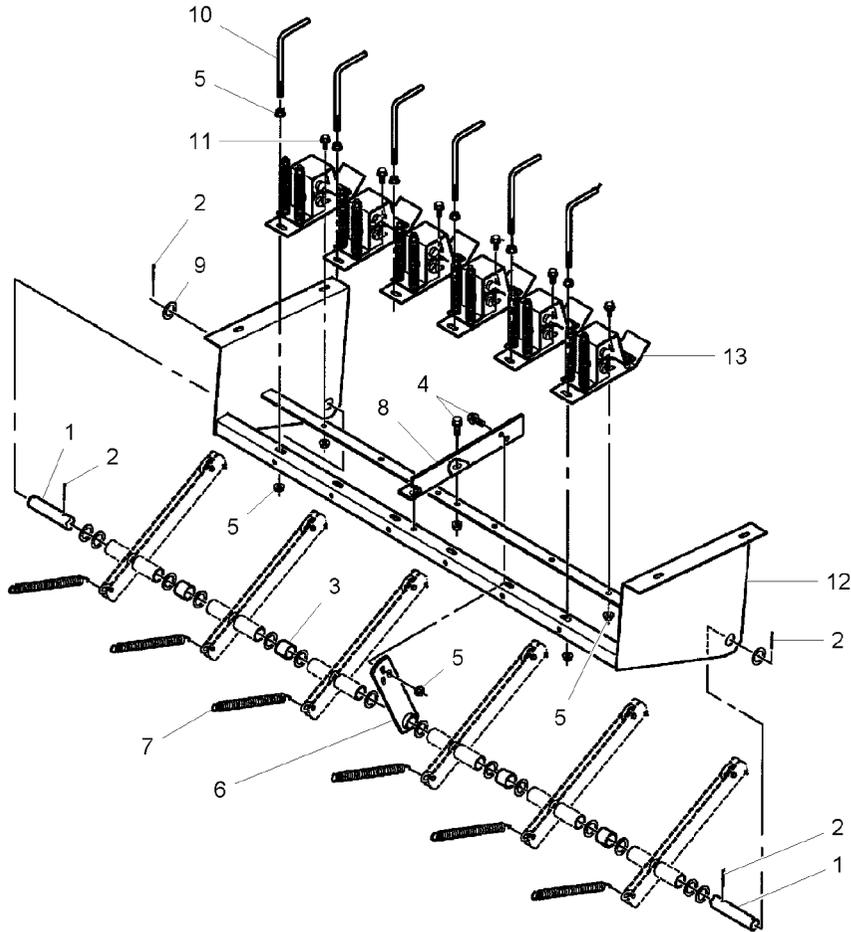

1	700113091		1	ROD	TRINGLE	STANGE
2	62190	5/32" X 1-1/2	4	PIN	ASTA	VARILLA
3	6280085		4	PIN	GOUPILLE	BOLZEN
4	7703424	3/8"-16 X 1	4	SPACER	PERNO	PASADOR
5	704247	3/8"-16	4	CAPSCREW	ENTRETOISE	ABSTANDSTUECK
6	700113093P		22	NUT	DISTANZIALE	DISCO ESPACIADOR
7	58875	➡ 190LB-50100	1	STRAP	VIS BOUCHON	HUTSCHRAUBE
7*	700714986B	➡ 190LB-50101	6	SPRING	TAPPO A VITE	TORNILLO TAPON
8*	700150621	➡ 190LB-50100	1	PIVOT	ECROU	MUTTER
8	6848832P	➡ 190LB-50101	1	STRAP	DADO	TUERCA
9	Y52258	1" X 14	1	STRAP	PATTE	LASCHE
10	702400048		6	SPRING	CORREGGIA	FAJA
11	7703432	3/8"-16 X 3/4	6	SPRING	RESSORT	FEDER
12	700129495P		6	SPRING	RESSORT	RESORTE
13*	6845077P	👁 50-85 No 1	1	PIVOT	MOLLA	FEDER
			1	ANGLE.	RESSORT	RESORTE
			16	BUSH	MOLLA	FEDER
			6	ROD	MOLLA	RESORTE
			6	CAPSCREW	PIVOT	DREHZAPFEN
			1	SUPPORT	CARDINE	PIVOTE
			6	TENSIONER	EQUERRE	WINKEL
					ANGOLO	ANGULO
					BAGUE	BUCHSE
					BOCCOLA	CASQUILLO
					TRINGLE	STANGE
					ASTA	VARILLA
					VIS BOUCHON	HUTSCHRAUBE
					TAPPO A VITE	TORNILLO TAPON
					SUPPORT	LAGERUNG
					SUPPORTO	DISPOS.DE SOSTEN
					TENDEUR	SPANNER
					TENDITORE	ENSOR

Knotter
 Noueur
 Binder
 Legatore
 Anudadora

50-65

Tension Adjusting - From 190lb-50147 - Up To H.M 91616
 Reglage De Tension - A Partir Du 190lb-50147 - Jusqu'au H.M 91616
 Spannungregler - Ab 190lb-50147 - Bis Den H.M 91616
 Regitro Della Tensione - Dalla 190lb-50147 - Fino Alla H.M 91616
 Reguladora De Latension - A Partir Del 190lb-50147 - Hasta H.M 91616

5-BA06-012-A

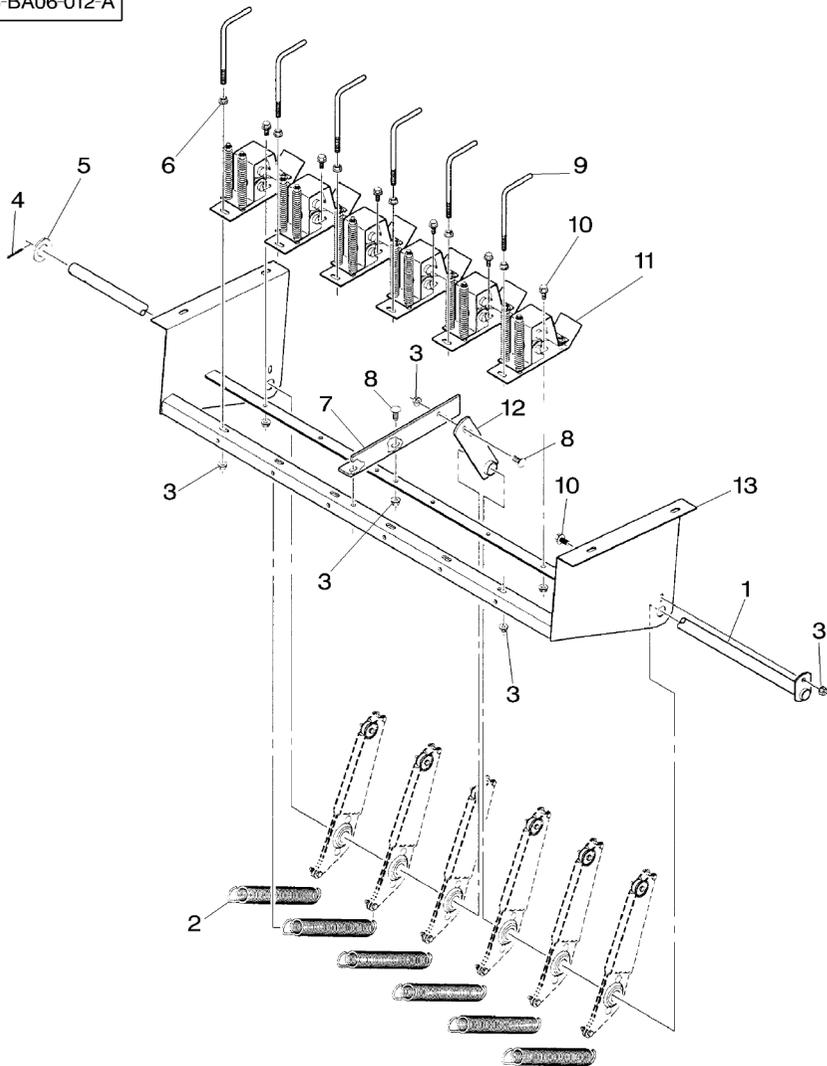

1	700137469P		1	ROD	TRINGLE	STANGE
2	★700714986B		6	SPRING	ASTA	VARILLA
3	700711238	3/8"-16	17	LOCKNUT	RESSORT	FEDER
4	62190	5/32" X 1-1/2			MOLLA	RESORTE
5	705574	1"	1	PIN	ECROU BLOCAGE	SICHERUNGSMUTTER
6	704247	3/8"-16	1	FLAT WASHERS	AUTOBLOCCANTE	CONTRATUERCA
7	6848832P				GOUPILLE	BOLZEN
8	70922786	3/8"-16 X 1	6	NUT	PERNO	PASADOR
9	702400048		1	ANGLE.	RONDELLES PLATES	UNTERLEGSCHIEBEN
10	7703432	3/8"-16 X 3/4	6	NUT	RONDELLE PIANA	ARANDELAS PLANAS
11	★6845077P	👁 50-85 No 1	1	ANGLE.	ECROU	MUTTER
12	700137477P	➡ ...	1	STRAP	DADO	TUERCA
12	700113093P	➡ ...	6	TENSIONER	EQUERRE	WINKEL
13	700129495P		4	BOLT	ANGOLO	ANGULO
			6	ROD	BOULON	MASCH.SCHRAUBE
			7	CAPSCREW	BULLONE	ESPIGA/BULON
			6	TENSIONER	TRINGLE	STANGE
			1	STRAP	ASTA	VARILLA
			1	STRAP	VIS BOUCHON	HUTSCHRAUBE
			1	SUPPORT	TAPPO A VITE	TORNILLO TAPON
					TENDEUR	SPANNER
					TENDITORE	TENSOR
					PATTE	LASCHE
					CORREGGIA	FAJA
					PATTE	LASCHE
					CORREGGIA	FAJA
					SUPPORT	LAGERUNG
					SUPPORTO	DISPOS.DE SOSTEN

Knotter
 Noueur
 Binder
 Legatore
 Anudadora

50-70

Tension Adjusting - From H.M 91617
 Reglage De Tension - A Partir Du H.M 91617
 Spannungregler - Ab H.M 91617
 Regitro Della Tensione - Dalla H.M 91617
 Reguladora De La Tensiona - Partir Del H.M 91617

5-BA06-045-A

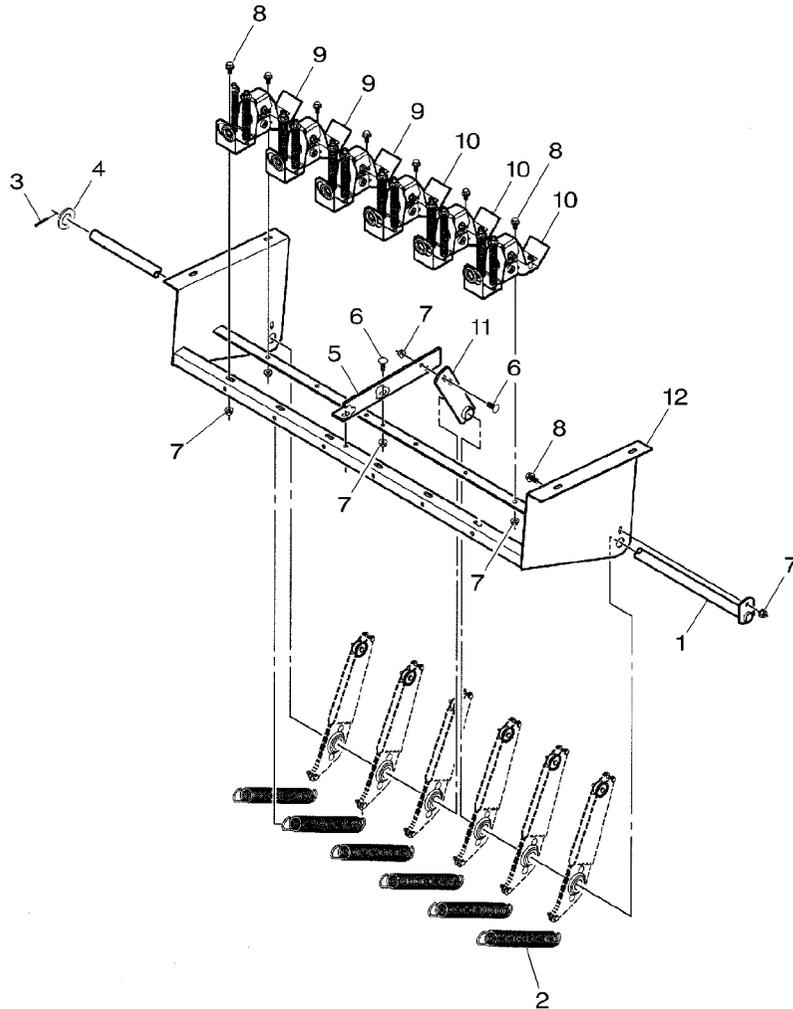

1	700137469P		1	ROD	TRINGLE	STANGE
2	★700714986B		6	SPRING	ASTA	VARILLA
3	62190	5/32" X 1-1/2			RESSORT	FEDER
4	705574	1"			MOLLA	RESORTE
5	6848832P		1	PIN	GOUPILLE	BOLZEN
6	70922786	3/8"-16 X 1			PERNO	PASADOR
7	700711238	3/8"-16	1	FLAT WASHERS	RONDELLES PLATES	UNTERLEGSCHIEBEN
8	7703432	3/8"-16 X 3/4			RONDELLE PIANA	ARANDELAS PLANAS
9	★700139336	👁 50-90 No 1			EQUERRE	WINKEL
10	★700139338	👁 50-90 No 1			ANGOLO	ANGULO
11	700113093P		4	BOLT	BOULON	MASCH.SCHRAUBE
12	700129495P		17	LOCKNUT	BULLONE	ESPIGA/BULON
					ECROU BLOCAGE	SICHERUNGSMUTTER
					AUTOBLOCCANTE	CONTRATUERCA
					VIS BOUCHON	HUTSCHRAUBE
					TAPPO A VITE	TORNILLO TAPON
					TENDEUR	SPANNER
					TENDITORE	TENSOR
					TENDEUR	SPANNER
					TENDITORE	TENSOR
					PATTE	LASCHE
					CORREGGIA	FAJA
					SUPPORT	LAGERUNG
					SUPPORTO	DISPOS.DE SOSTEN

Frame
Chassis
Rahmen
Telaio
Bastidor

50-75

➔ 190LB-50146

5 BA26 003 A

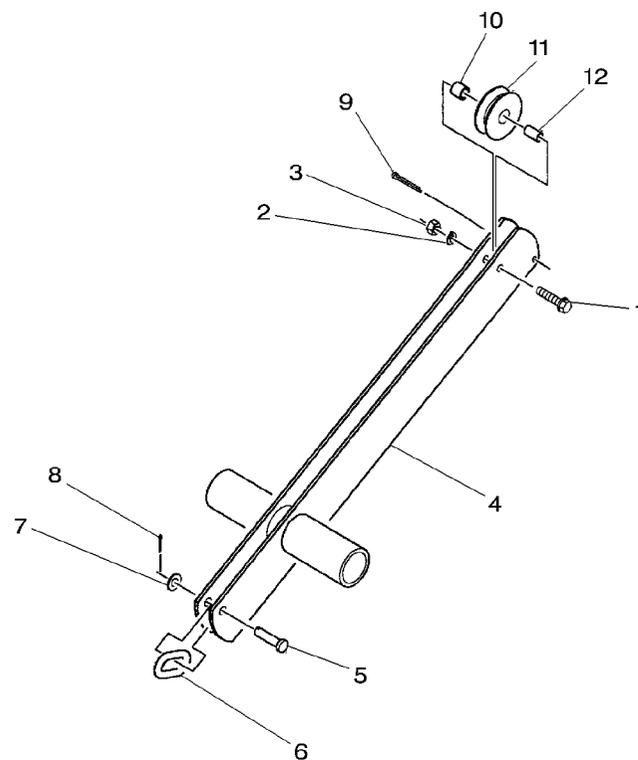

1	771345	No 10-24 X 1	1	CAPSCREW	VIS BOUCHON	HUTSCHRAUBE
2	★705004	No 10	1	LOCK WASHER	TAPPO A VITE	TORNILLO TAPON
3	★354120X1	No 10-24	1	NUT	RONDELLE FREIN	FEDERRING
4	6578751		1	ARM	ROSETTA DENTELL.	ARANDELA GROWER
5	763136	1/4" X 1	1	PIN	ECROU	MUTTER
6	89987		1	CHAIN	DADO	TUERCA
7	★70918264	1/4"	1	WASHER	BRAS	ARM
8	62018	1/16" X 1/2	1	PIN	BRACCIO	BRAZO
9	★62117	1/8" X 1-1/4	1	PIN	GOUPILLE	BOLZEN
10	7849656		1	SLEEVE	PERNO	PASADOR
11	6529945		1	ROLLER	CHAINE	KETTE
12	7849110		1	BUSH	CATENA	CADENA
					RONDELLE	UNTERLEGSCHIEBE
					RONDELLA	ARANDELA
					GOUPILLE	BOLZEN
					PERNO	PASADOR
					GOUPILLE	BOLZEN
					PERNO	PASADOR
					MANCHON	HUELSE
					MANICOTTO	MANCHA
					GALET	ROLLE
					RULLO	RODILLO
					BAGUE	BUCHSE
					BOCCOLA	CASQUILLO

Frame
Chassis
Rahmen
Telaio
Bastidor

50-80

➔ 190LB-50147

5-BA26-005-A

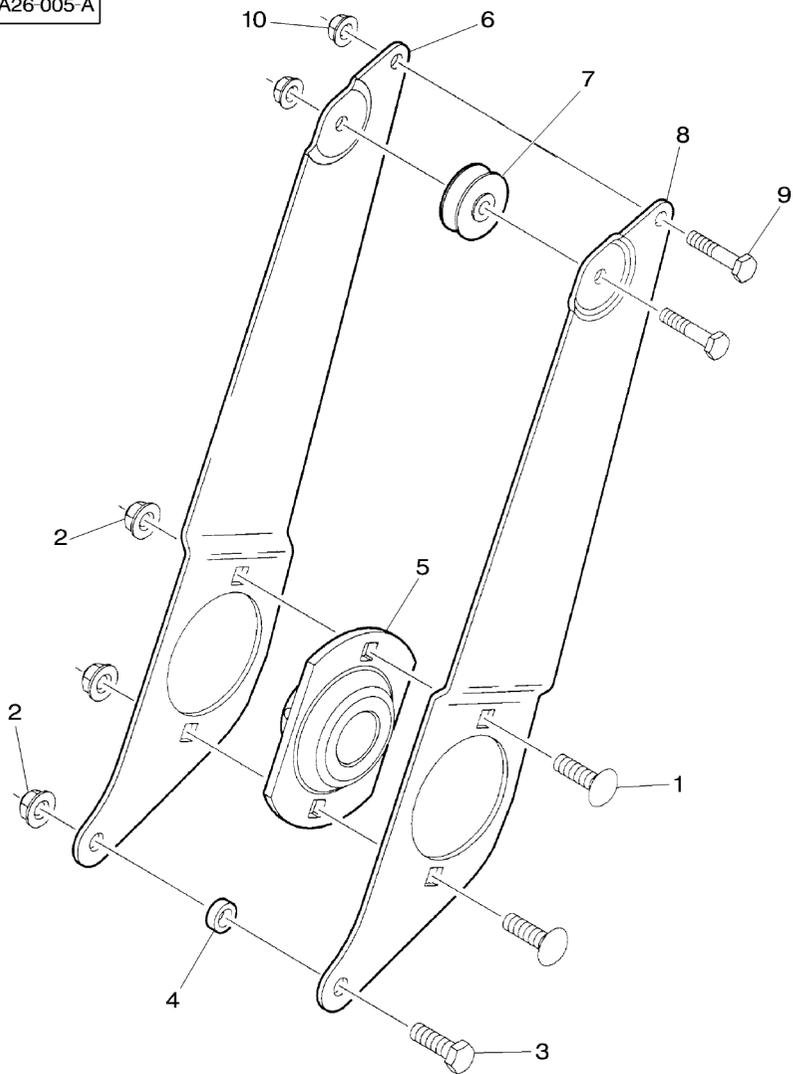

1	★7700578	5/16"-18 X 1	2	SCREW	VIS	SCHRAUBE
2	Y704726	5/16"-18			VITE	TORNILLO
3	★70921333	5/16"-18 X 1	3	LOCKNUT	ECROU BLOCAGE	SICHERUNGSMUTTER
4	6514772				AUTOBLOCCANTE	CONTRATUERCA
5	700715941		1	CAPSCREW	VIS BOUCHON	HUTSCHRAUBE
6	700137467P	▶	1	SPACER	TAPPO A VITE	TORNILLO TAPON
7	700722661		1	BEARING FLANGE	ENTRETOISE	ABSTANDSTUECK
8	700137466P	◀			DISTANZIALE	DISCO ESPACIADOR
9	★7703473	1/4"-20 X 1-1/4	1	ARM	FLASQUE ROULT	LAGERFLANSCH
10	1703354	1/4"-20			BEARING FLANGE	BEARING FLANGE
			1	ARM	BRAS	ARM
					BRACCIO	BRAZO
			1	BALL BEARING	ROULEMENT BILLES	KUGELLAGER
					CUSCINETTO SFERE	COJINETE DE BOLA
			1	ARM	BRAS	ARM
					BRACCIO	BRAZO
			2	CAPSCREW	VIS BOUCHON	HUTSCHRAUBE
					TAPPO A VITE	TORNILLO TAPON
			2	NUT	ECROU	MUTTER
					DADO	TUERCA

Knotter
 Noueur
 Binder
 Legatore
 Anudadora

50-85

Tension Adjusting - Up To H.M 91616
 Reglage De Tension - Jusqu' Au H.M 91616
 Spannungregler - Bis Den H.M 91616
 Regitro Della Tensione - Fino Alla H.M 91616
 Reguladora De La Tension - Hasta H.M 91616

5 BA06 008 A

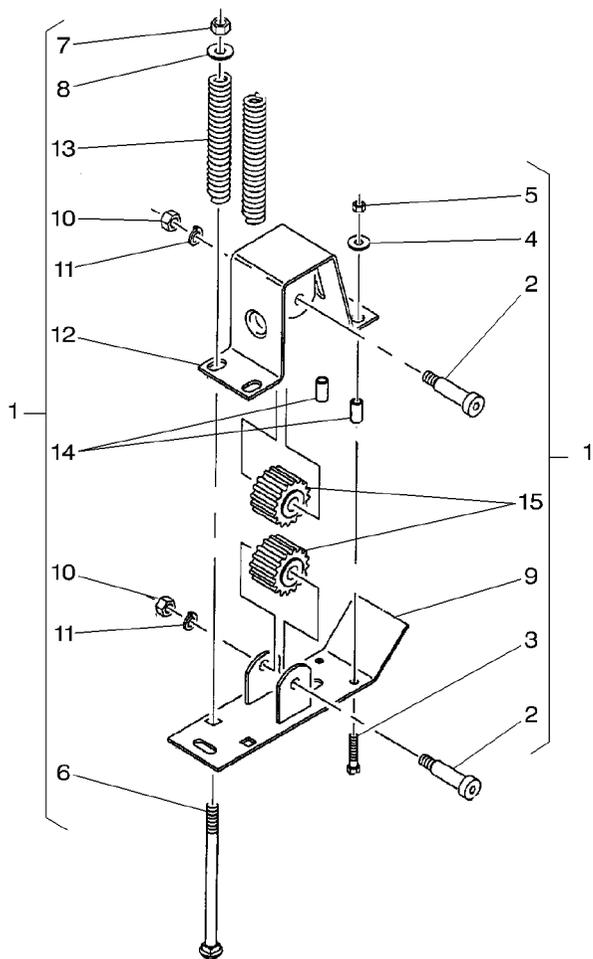

1	★6845077P		1	TENSIONER	TENDEUR	SPANNER
2	8701781	1	2	SCREW	TENDITORE	SENSOR
3	★7703473	1 1/4"-20 X 1-1/4	2	CAPSCREW	VIS	SCHRAUBE
4	★70916622	1 1/4"-20	2	NUT	VITE	TORNILLO
5	★70917377	1 1/4"	2	FLAT WASHERS	VIS BOUCHON	HUTSCHRAUBE
6	★7770571	1 3/8"-16 X 6	2	BOLT	TAPPO A VITE	TORNILLO TAPON
7	7704141	1 3/8"-16	2	LOCKNUT	ECROU	MUTTER
8	★70917378	1 3/8"	2	FLAT WASHERS	DADO	TUERCA
9	6845135P	1	1	PLATE	RONDELLES PLATES	UNTERLEGSCHIEBEN
10	★70916950	1 3/8"-16	2	NUT	RONDELLE PIANA	ARANDELAS PLANAS
11	★70916965	1 3/8"	2	LOCK WASHER	BOULON	MASCH.SCHRAUBE
12	6845101P	1	2	BRACKET	BULLONE	ESPIGA/BULON
13	858027	1	2	COMP.SPONG	ECROU BLOCAGE	SICHERUNGSMUTTER
14	6530828P	1	2	SPACER	AUTOBLOCCANTE	CONTRATUERCA
15	8802795	1	2	GEAR	RONDELLES PLATES	UNTERLEGSCHIEBEN
					RONDELLE PIANA	ARANDELAS PLANAS
					PLAQUE	PLATTE
					PIASTRA	PLATO
					ECROU	MUTTER
					DADO	TUERCA
					RONDELLE FREIN	FEDERRING
					ROSETTA DENTELL.	ARANDELA GROWER
					SUPPORT FIXATION	HALTEARM
					STAFFETTA	SOPORTE
					RESSORT DE COMPR	DRUCKFEDER
					MOLLA COMPOSTA	RESORTE DE COMP.
					ENTRETOISE	ABSTANDSTUECK
					DISTANZIALE	DISCO ESPACIADOR
					ENGRENAGE	ZAHNRAD
					INGRANAGGIO	ENGRANAJE

Knotter
 Noueur
 Binder
 Legatore
 Anudadora

50-90

Tension Adjusting - From H.M 91617
 Reglage De Tension - A Partir Du H.M 91617
 Spannungregler - Ab H.M 91617
 Regitro Della Tensione - Dalla H.M 91617
 Reguladora De La Tension - Despues EI H.M 91617

5-BA06-038-B

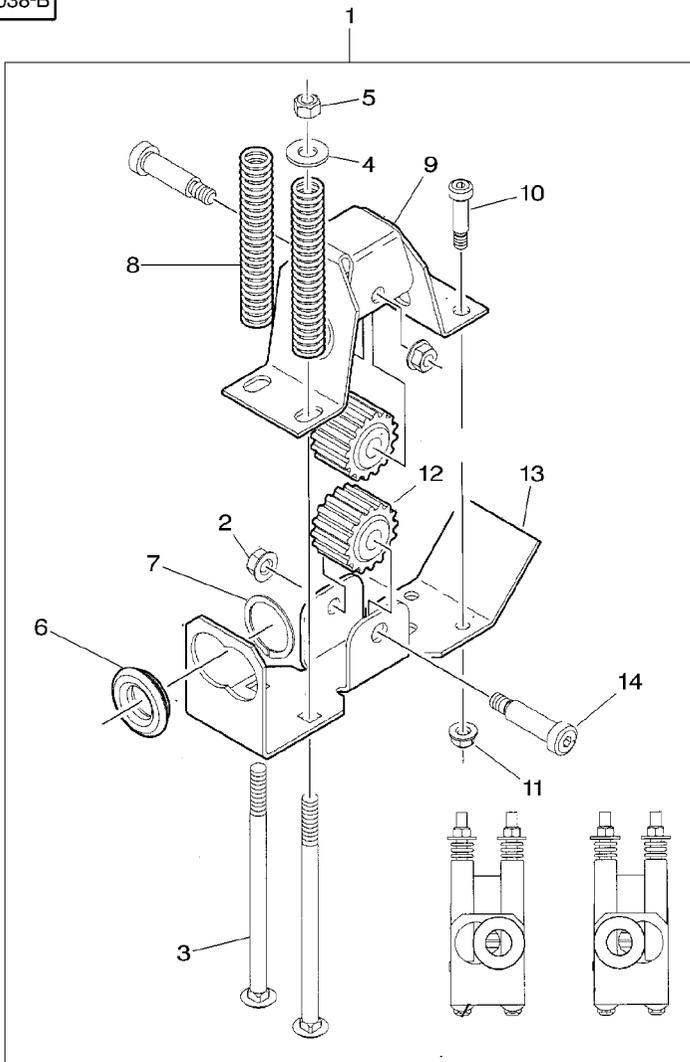

1	★700139336	▶	1	TENSIONER	TENDEUR	SPANNER
1	★700139338	◀	1	TENSIONER	TENDITORE	TENSOR
2	704247		2	NUT	TENDEUR	SPANNER
3	7770589		1	3/8"-16	TENDITORE	TENSOR
4	★70917378		2	BOLT	ECROU	MUTTER
5	7704141		2	NUT	DADO	TUERCA
6	700139255		1	3/8"-16 X 6-1/2	BOULON	MASCH.SCHRAUBE
7	70927744		1	3/8"	BULLONE	ESPIGA/BULON
8	858027		2	FLAT WASHERS	RONDELLES PLATES	UNTERLEGSCHIEBEN
9	★700164445		2	LOCKNUT	RONDELLE PIANA	ARANDELAS PLANAS
10	72835		1	GUIDE	ECROU BLOCAGE	SICHERUNGSMUTTER
11	Y704726		1	SNAPRING	AUTOBLOCCANTE	CONTRATUERCA
12	8802795		1	COMP.SPRING	GUIDE	FUEHRUNG
13	700139339P		1	PLATE	GUIDA	GUIA
14	8701781		2	SCREW	SEGMENT ARRET	SPRENGRING
			1	700163380P	ANELLO SIEGER	ANILLA RETENCION
			1	3/8" X 1 X 5/16	RESSORT DE COMPR	DRUCKFEDER
			2	LOCKNUT	MOLLA COMPOSTA	RESORTE DE COMP.
			2	GEAR	PLAQUE	PLATTE
			1	PLATE	PIASTRA	PLATO
			2	BOLT	BOULON	MASCH.SCHRAUBE
			2	GEAR	BULLONE	ESPIGA/BULON
			1	PLATE	ECROU BLOCAGE	SICHERUNGSMUTTER
			2	SCREW	AUTOBLOCCANTE	CONTRATUERCA
			1	700139339P	INGRANAGGIO	ENGRANAJE
			2	SCREW	PLAQUE	PLATTE
			1	PLATE	PIASTRA	PLATO
			2	SCREW	VIS	SCHRAUBE
			1	700139339P	VITE	TORNILLO

Star Wheel
 Declencheur
 Strohrad
 Braccio Di Scatto
 Rueda Medicion

50-95

➔ 190LB-50146

5-BA33-002-C

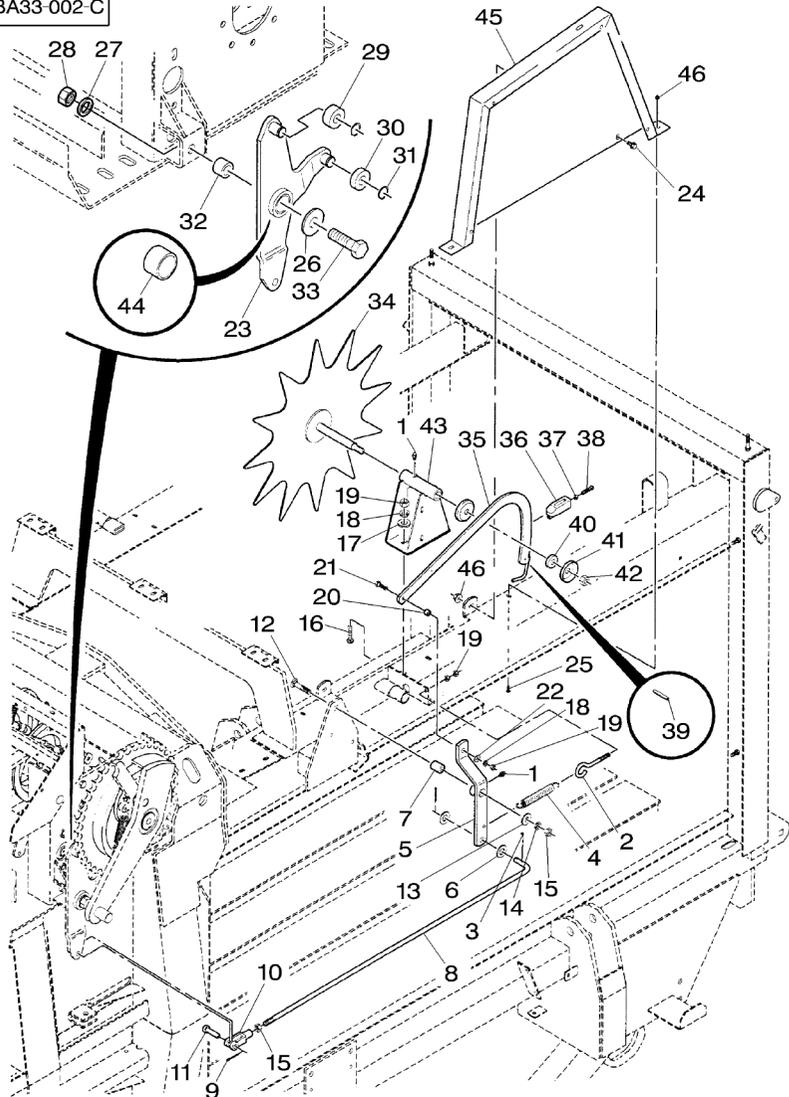

1	70914465	[A]	2	GREASE NIPPLE	GRAISSEUR DROIT	FETT-NIPPEL
2	766485	1/8"-27		INGRASSAT.		ENGRASADOR
3	★62174	3/8" X 5	1	EYE BOLT	BOULON A OEIL	AUGENSCHRAUBE
4	758441			GOLFARE		CANCAMO
5	6530588P		2	PIN	GOUPILLE	BOLZEN
6	705541	1/2"	1	TENSION SPRING	PERNO	PASADOR
7	6530638P			RESSORT TRACTION		ZUGFEDER
8	700113105P			MOLLA TENDITRICE		MUELLE TENSION
9	★70918452	1/8" X 1	1	ARM	BRAS	ARM
10	70937465			BRACCIO		BRAZO
11	70929593	1/2" X 1-1/2	2	WASHER	RONDELLE	UNTERLEGSCHIEBE
12	★70927493	1/2"-13 X 2-1/2		RONDELLA		ARANDELA
13	★70918431	1/2"	1	BUSH	BAGUE	BUCHSE
14	★Y705046	1/2"	1	ROD	BOCCOLA	CASQUILLO
15	★704031	1/2"-13		TRINGLE		STANGE
16	★70923220	3/8"-16 X 1-1/4	1	ROD	ASTA	VARILLA
17	Y705533	3/8"	1	PIN	GOUPILLE	BOLZEN
18	★70916965	3/8"	1	YOKE	PERNO	PASADOR
19	★70916950	3/8"-16		CHAPE ARTICULAT		GELENKGABEL
20	6530646P		1	FORCELLA		YUGO
21	★70920415	3/8"-16 X 1-1/4	1	GOUPILLE		BOLZEN
22	★70917378	3/8"	1	PERNO		PASADOR
23	700113362M	➔ 190LB-50100	1	BOULON		MASCH.SCHRAUBE
23	700124053	➔ 190LB-50101	1	BULLONE		ESPIGA/BULON
24	7883325	5/16"-18 X 3/4	1	WASHER	RONDELLE	UNTERLEGSCHIEBE
25	★7700578	5/16"-18 X 1	1	LOCK WASHER	RONDELLA	ARANDELA
			2	NUT	RONDELLE FREIN	FEDERRING
			2	BOLT	ROSETTA DENTELL.	ARANDELA GROWER
			2	WASHER	ECROU	MUTTER
			3	LOCK WASHER	DADO	TUERCA
			5	NUT	BOULON	MASCH.SCHRAUBE
			1	BUSH	BULLONE	ESPIGA/BULON
			1	CAPSCREW	RONDELLE	UNTERLEGSCHIEBE
			1	FLAT WASHERS	RONDELLA	ARANDELA
			1	ARM	RONDELLE FREIN	FEDERRING
			1	ARM	ROSETTA DENTELL.	ARANDELA GROWER
			2	SCREW	ECROU	MUTTER
			2	SCREW	DADO	TUERCA
					BAGUE	BUCHSE
					BOCCOLA	CASQUILLO
					VIS BOUCHON	HUTSCHRAUBE
					TAPPO A VITE	TORNILLO TAPON
					RONDELLES PLATES	UNTERLEGSCHIEBEN
					RONDELLE PIANA	ARANDELAS PLANAS
					BRAS	ARM
					BRACCIO	BRAZO
					BRAS	ARM
					BRACCIO	BRAZO
					VIS	SCHRAUBE
					VITE	TORNILLO
					VIS	SCHRAUBE
					VITE	TORNILLO

Star Wheel
 Declencheur
 Strohrad
 Braccio Di Scatto
 Rueda Medicion

50-95

➔ 190LB-50146

5-BA33-002-C

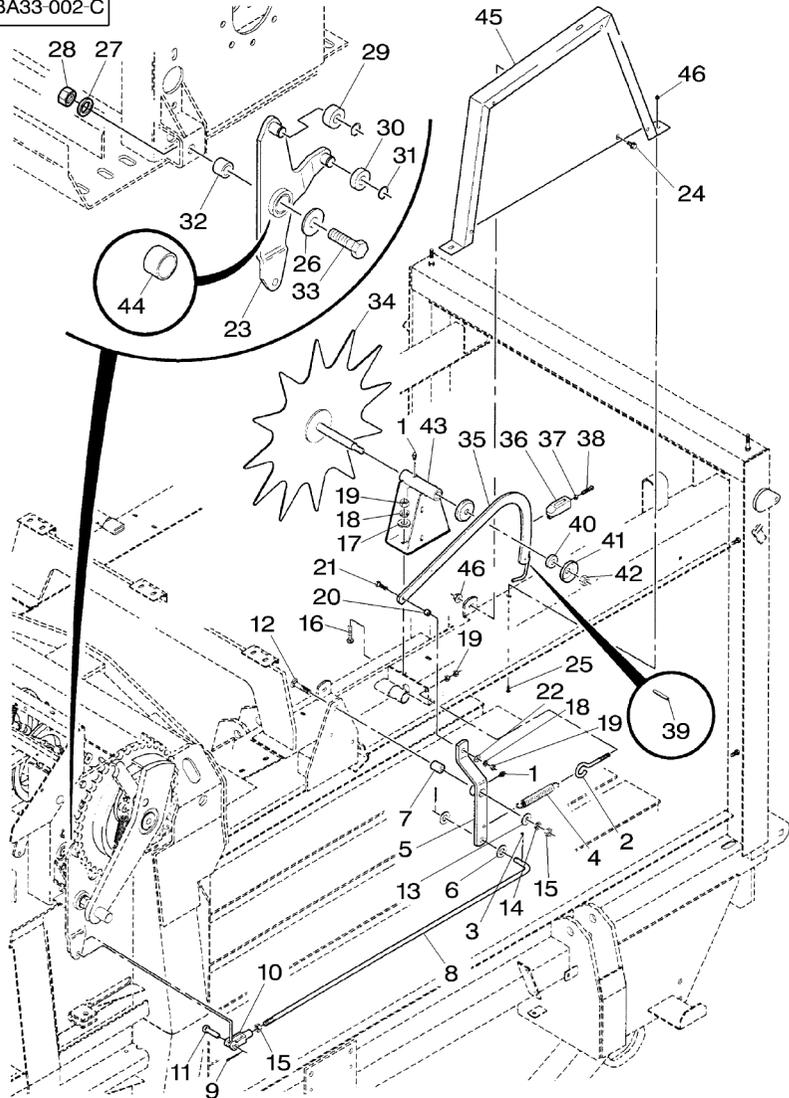

26★70918433	3/4"	1	FLAT WASHERS	RONDELLES PLATES	UNTERLEGSCHIEBEN
27 353440X1	➔ 190LB-50100	1	LOCK WASHER	RONDELLE PIANA	ARANDELAS PLANAS
28 375100X1	➔ 190LB-50100	1	NUT UNC	RONDELLE FREIN	FEDERRING
28 700703923	➔ 190LB-50101	1	LOCKNUT	ROSETTA DENTELL.	ARANDELA GROWER
29 6524870P	➔ 190LB-50100	1	ROLLER	ECROU UNC	MUTTER UNC
29 700124056P	➔ 190LB-50101	1	ROLLER	DADO UNC	TUERCA UNC
30 6525042P		1	ROLLER	ECROU BLOCAGE	SICHERUNGSMUTTER
31 70927732		2	SNAPRING	AUTOBLOCCANTE	CONTRATUERCA
32 6533012	➔ 190LB-50100	1	SPACER	GALET	ROLLE
32 700106397	➔ 190LB-50101	1	SPACER	RULLO	RODILLO
33★70925149	3/4"-10 X 2-1/2	1	CAPSCREW	GALET	ROLLE
34 6530307P		1	WHEEL	RULLO	RODILLO
35 6530232		1	ARM	GALET	ROLLE
36 6844823		1	CLAMP	RULLO	RODILLO
37 70920161	5/16"-18	1	NUT	GALET	ROLLE
38 69732	5/16"-18 X 1-1/2	1	SETSCREW	RULLO	RODILLO
39 70916171	1/4" X 1-1/2	1	PIN	SEGMENT ARRET	SPRENGRING
40 6530489P		1	SPACER	ANELLO SIEGER	ANILLA RETENCION
41 6530471P		2	SHIELD	ENTRETOISE	ABSTANDSTUECK
42★70932665	5/8"-11	1	NUT	DISTANZIALE	DISCO ESPACIADOR
43 6530265		1	BRACKET	ENTRETOISE	ABSTANDSTUECK
44 52779	23	1	BUSH	DISTANZIALE	DISCO ESPACIADOR
45 700133656P		1	SHIELD	VIS BOUCHON	HUTSCHRAUBE
46 70931277	5/16"-18	4	NUT	TAPPO A VITE	TORNILLO TAPON
				ROU	RAD
				RUOTA	RUEDA
				BRAS	ARM
				BRACCIO	BRAZO
				COLLIER	HALTESCHELLE
				FASCETTA	ABRAZADERA
				ECROU	MUTTER
				DADO	TUERCA
				VIS DE BLOCAGE	STELLSCHRAUBE
				INSIEME VITI	SET SCREW
				GOUPILLE	BOLZEN
				PERNO	PASADOR
				ENTRETOISE	ABSTANDSTUECK
				DISTANZIALE	DISCO ESPACIADOR
				TOLE	SCHILD
				RIPARO	BLINDAJE
				ECROU	MUTTER
				DADO	TUERCA
				SUPPORT FIXATION	HALTEAMM
				STAFFETTA	SOPORTE
				BAGUE	BUCHSE
				BOCCOLA	CASQUILLO
				TOLE	SCHILD
				RIPARO	BLINDAJE
				ECROU	MUTTER
				DADO	TUERCA

Star Wheel
Declencheur
Strohrad
Braccio Di Scatto
Rueda Medicion

50-95

➔ 190LB-50146

5-BA33-002-C

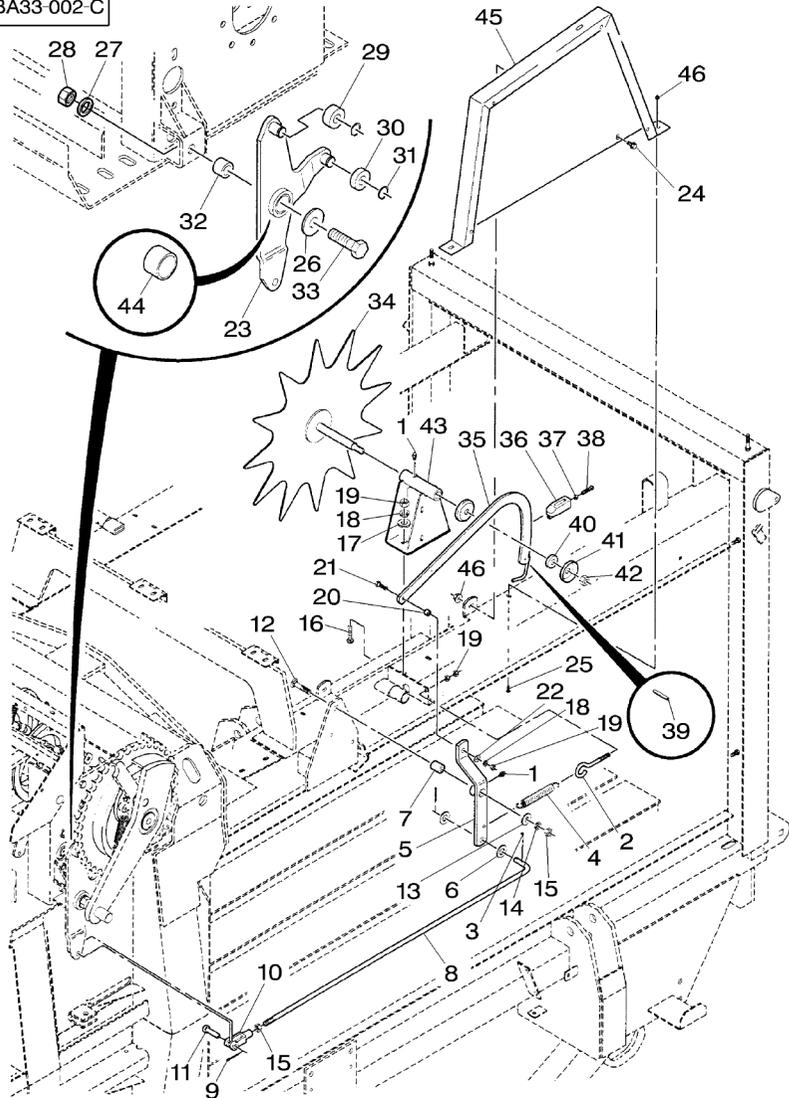

[A] USED ONLY ON UNIT WITHOUT CENTRALIZED LUBRICATION SYSTEM
UTILISE A DEFAUT DE LUBRIFICATION CENTRALISE
VERWENDEN WENN KEINE ZENTRALSCHMIERUNG
UTIZZARE SE NON LUBRIFICAZIONE CENTRALE
USAR SI NO ENGRASE CENTRAL

Star Wheel
 Declencheur
 Strohrad
 Braccio Di Scatto
 Rueda Medicion

50-100

➔ 190LB-50147

5-BA33-005-C

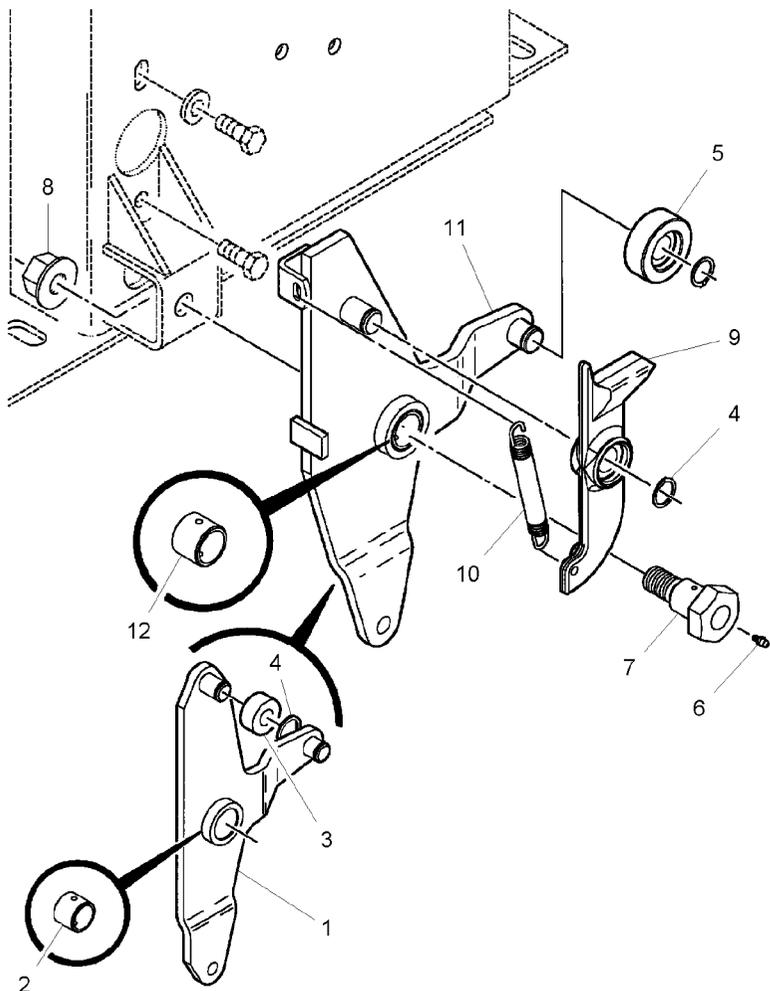

1	★700137490P	➔ 190LB-50246	1	ARM	BRAS BRACCIO	ARM BRAZO
2	★8050536	1	1	BEARING	COUSSINET CUSCINETTO	LAGER COJINETE
3	★700124056P	➔ 190LB-50246	1	ROLLER	GALET RULLO	ROLLE RODILLO
4	70927732		2	SNAPRING	SEGMENT ARRET ANELLO SIEGER	SPRENGRING ANILLA RETENCION
5	700138225		1	ROLLER	GALET RULLO	ROLLE RODILLO
6	70923219	1/4"-28	1	GREASER	GRAISSEUR INGRASSATORE	FETTNIPPEL ENGRASADOR
7	700137492		1	BOLT	BOULON BULLONE	MASCH.SCHRAUBE ESPIGA/BULON
8	700703923	3/4"-10	1	LOCKNUT	ECROU BLOCAGE AUTOBLOCCANTE	SICHERUNGSMUTTER CONTRATUERCA
9	★700138224	➔ 190LB-50247	1	LEVER	LEVIER	HEBEL
10	★700714166	➔ 190LB-50247	1	SPRING	RESSORT	PALANCA FEDER
11	★700138219	➔ 190LB-50247	1	ARM	MOLLA	RESORTE
12	★8050536	11	1	BEARING	BRAS BRACCIO	ARM BRAZO
					COUSSINET CUSCINETTO	LAGER COJINETE

Star Wheel
Declencheur
Strohrad
Braccio Di Scatto
Rueda Medicion

50-105

From 190lb-50147 - Up To H.M 91459
A Partir Du 190lb-50147 - Jusqu' Au H.M 91459
Ab 190lb-50147 - Bis Den H.M 91459
Dalla 190lb-50147 - Fino Alla H.M 91459
A Partir Del 190lb-50147 - Hasta H.M 91459

5-BA33-004-D

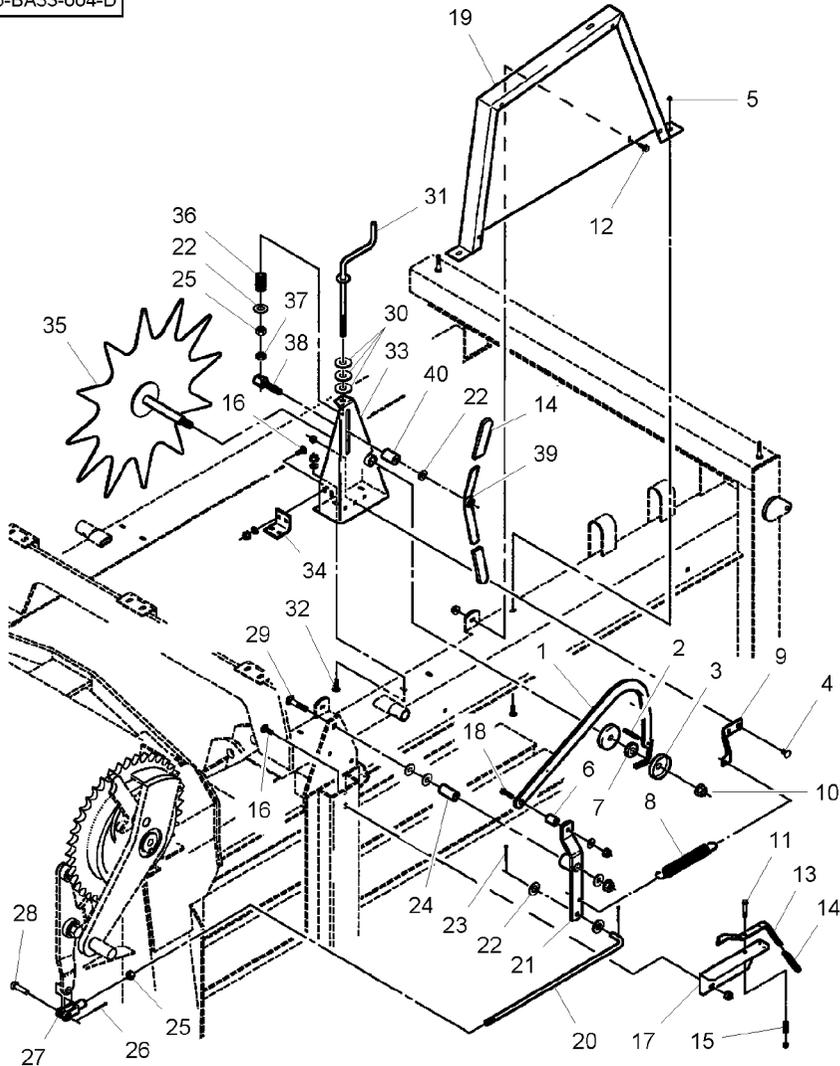

1	★6530232		1	ARM	BRAS	ARM
2	★70916171	1/4" X 1-1/2	1	PIN	BRACCIO	BRAZO
3	★700123850P		1	SHIELD	GOUPILLE	BOLZEN
4	★70922784	3/8"-16 X 3/4	2	BOLT	PERNO	PASADOR
4	★700711238	3/8"-16	2	LOCKNUT	TOLE	SCHILD
5	★7700578	5/16"-18 X 1	2	SCREW	RIPARO	BLINDAJE
5	★70931277	5/16"-18	2	NUT	BOULON	MASCH.SCHRAUBE
6	★6530646P		1	BUSH	BULLONE	ESPIGA/BULON
7	★6530489P		1	SPACER	ECROU BLOCAGE	SICHERUNGSMUTTER
8	★758441		1	TENSION SPRING	AUTOBLOCCANTE	CONTRATUERCA
9	★700134937P		1	SUPPORT	VIS	SCHRAUBE
10	★700703922	5/8"-11	1	LOCKNUT	VITE	TORNILLO
11	★7702079	3/8"-16 X 2-1/2	1	CAPSCREW	ECROU	MUTTER
11	★Y704734	3/8"-16	1	LOCKNUT	DADO	TUERCA
12	★7883325	5/16"-18 X 3/4	2	SCREW	BAGUE	BUCHSE
12	★70931277	5/16"-18	2	NUT	BOCCOLA	CASQUILLO
13	★700129686P	➡ HK 91221	1	LEVER	ENTRETOISE	ABSTANDSTUECK
14	★827360		3	GRIP	DISTANZIALE	DISCO ESPACIADOR
15	★58644	➡ HK 91221	1	SPRING	RESSORT TRACTION	ZUGFEDER
16	★70922786	3/8"-16 X 1	5	BOLT	MOLLA TENDITRICE	MUELLE TENSION
16	★Y705533	3/8"	5	WASHER	SUPPORT	LAGERUNG
16	★700711238	3/8"-16	5	LOCKNUT	SUPPORTO	DISPOS.DE SOSTEN
17	★700138844P	➡ HK 91221	1	SUPPORT	ECROU BLOCAGE	SICHERUNGSMUTTER
18	★70920415	3/8"-16 X 1-1/4	1	CAPSCREW	AUTOBLOCCANTE	CONTRATUERCA
18	★70917378	3/8"	1	FLAT WASHERS	SUPPORT	LAGERUNG
18	★700711238	3/8"-16	1	LOCKNUT	SUPPORTO	DISPOS.DE SOSTEN
					VIS BOUCHON	HUTSCHRAUBE
					TAPPO A VITE	TORNILLO TAPON
					RONDELLES PLATES	UNTERLEGSCHIEBEN
					RONDELLE PIANA	ARANDELAS PLANAS
					ECROU BLOCAGE	SICHERUNGSMUTTER
					AUTOBLOCCANTE	CONTRATUERCA

Star Wheel
 Declencheur
 Strohrad
 Braccio Di Scatto
 Rueda Medicion

50-105

From 190lb-50147 - Up To H.M 91459
 A Partir Du 190lb-50147 - Jusqu'au H.M 91459
 Ab 190lb-50147 - Bis Den H.M 91459
 Dalla 190lb-50147 - Fino Alla H.M 91459
 A Partir Del 190lb-50147 - Hasta H.M 91459

5-BA33-004-D

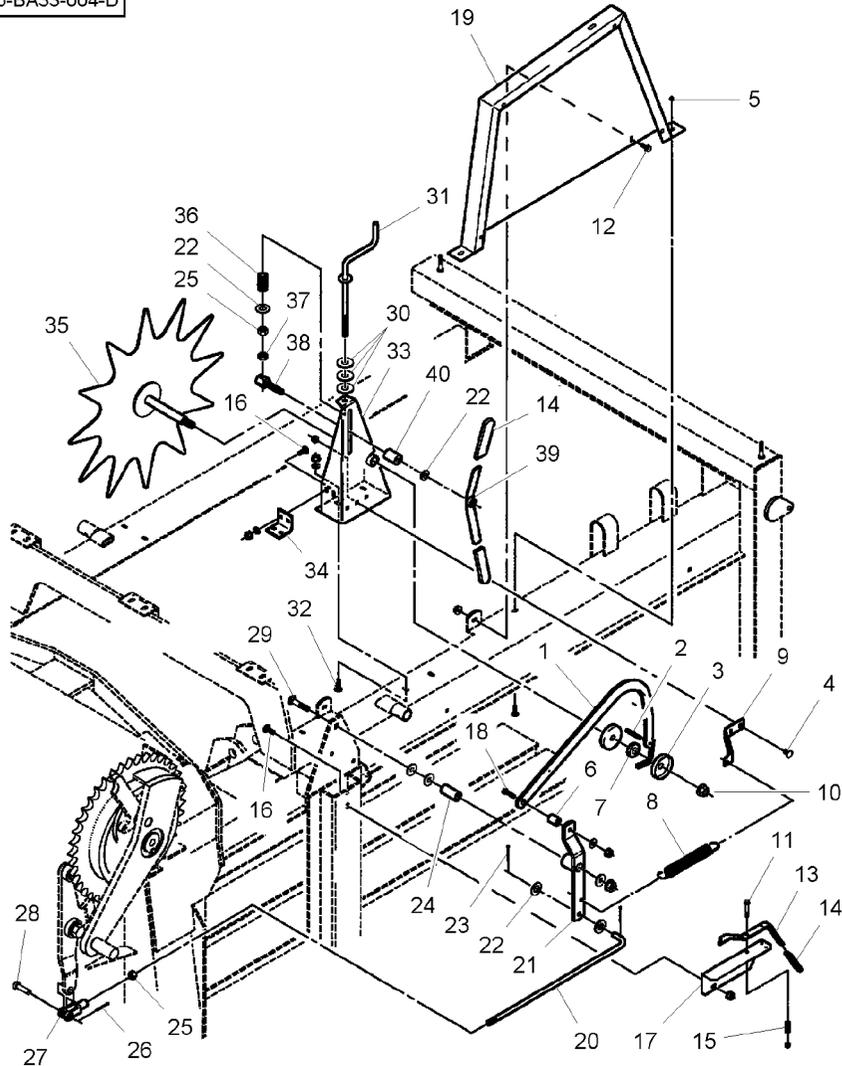

19★700133656P		1 SHIELD	TOLE	SCHILD
20★700113105P		1 ROD	RIPARO	BLINDAJE
21★6530588P		1 ARM	TRINGLE	STANGE
22★705541	1/2"	4 WASHER	ASTA	VARILLA
23★62174	5/32" X 1	2 PIN	BRAS	ARM
24★6530638P		1 BUSH	BRACCIO	BRAZO
25★704031	1/2"-13	2 NUT	RONDELLE	UNTERLEGSCHIEBE
26★70918452	1/8" X 1	1 PIN	RONDELLA	ARANDELA
27★70937465		1 YOKE	GOUPILLE	BOLZEN
28★70929593	1/2" X 1-1/2	1 PIN	PERNO	PASADOR
29★70927493	1/2"-13 X 2-1/2	1 BOLT	BAGUE	BUCHSE
29★700711557	1/2"	3 WASHER	BOCCOLA	CASQUILLO
29★700714586	1/2"-13	1 NUT	ECROU	MUTTER
30★700711557	1/2"	3 WASHER	DADO	TUERCA
31★700134938		1 CRANK	GOUPILLE	BOLZEN
32★70923220	3/8"-16 X 1-1/4	2 BOLT	PERNO	PASADOR
32★Y705533	3/8"	2 WASHER	CHAPE ARTICULAT	GELENKGABEL
32★700711238	3/8"-16	2 LOCKNUT	FORCELLA	YUGO
33★700134931P		1 BRACKET	GOUPILLE	BOLZEN
34★700134449P		1 ANGLE.	PERNO	PASADOR
35★6530307P		1 WHEEL	BOULON	MASCH.SCHRAUBE
36★58024B		1 SPRING	BULLONE	ESPIGA/BULON
37★704056	1/2"-13	1 NUT	RONDELLE	UNTERLEGSCHIEBE
38★700134527		1 SHAFT	RONDELLA	ARANDELA
39★700134935		1 LEVER	ECROU BLOCCAGE	SICHERUNGSMUTTER
40★6234710		1 SPACER	AUTOBLOCCANTE	CONTRATUERCA
			SUPPORT FIXATION	HALTEAMM
			STAFFETTA	SOPORTE
			EQUERRE	WINKEL
			ANGOLO	ANGULO
			ROUE	RAD
			RUOTA	RUEDA
			RESSORT	FEDER
			MOLLA	RESORTE
			ECROU	MUTTER
			DADO	TUERCA
			ARBRE	WELLE
			ALBERO	ARBOL
			LEVIER	HEBEL
			LEVA	PALANCA
			ENTRETOISE	ABSTANDSTUECK
			DISTANZIALE	DISCO ESPACIADOR

Star Wheel
 Declencheur
 Strohrad
 Braccio Di Scatto
 Rueda Medicion

50-110

➔ HM 91460

5-BA33-012-A

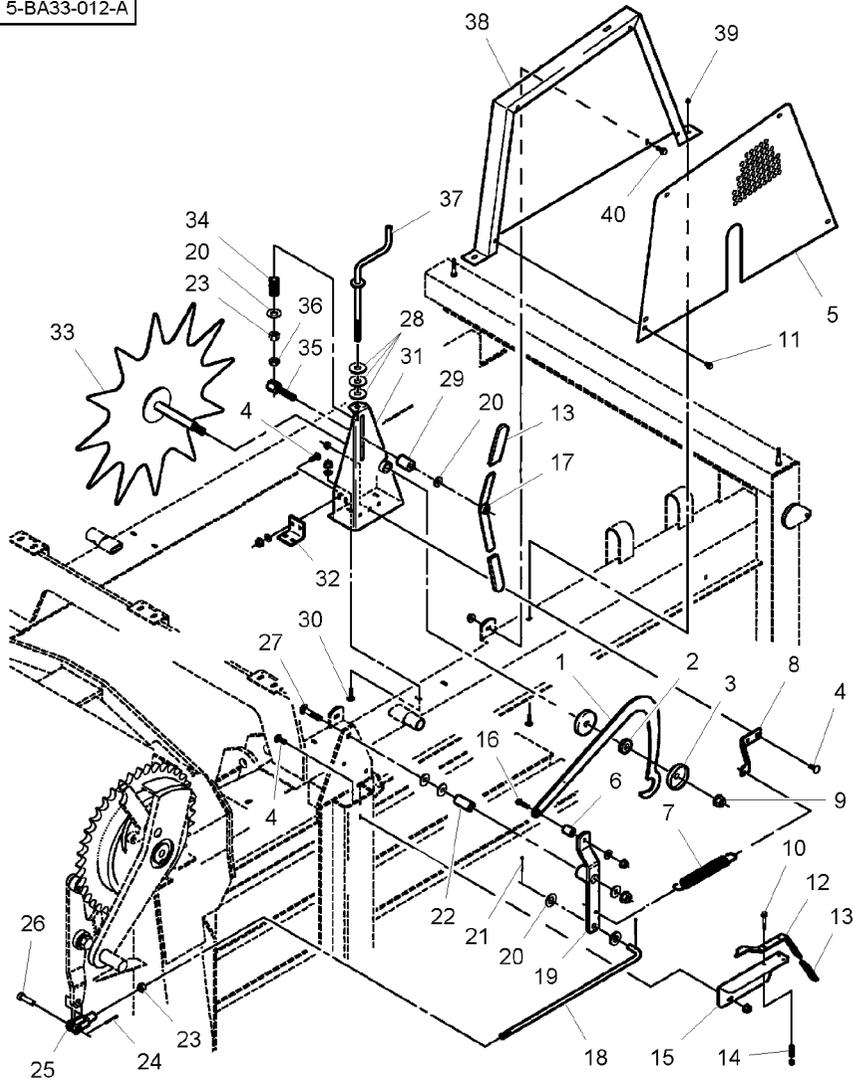

1	★700136933P		1	ARM	BRAS	ARM
2	★2401516P		1	SPACER	BRACCIO	BRAZO
3	★700123850P		1	SHIELD	ENTRETOISE	ABSTANDSTUECK
4	★70922786	3/8"-16 X 1	7	BOLT	DISTANZIALE	DISCO ESPACIADOR
4	★Y705533	3/8"	2	WASHER	TOLE	SCHILD
4	★700711238	3/8"-16	7	LOCKNUT	RIPARO	BLINDAJE
5	★700133658P		7	COVER	BULON	MASCH.SCHRAUBE
6	★6530646P		7	BUSH	BULLONE	ESPIGA/BULON
7	★700709636B		7	SPRING	RONDELLE	UNTERLEGSCHIEBE
8	★700136934		7	LOCKNUT	RONDELLA	ARANDELA
9	★700703922	5/8"-11	7	LOCKNUT	ECROU BLOCCAGE	SICHERUNGSMUTTER
10	★7702079	3/8"-16 X 2-1/2	1	CAPSCREW	AUTOBLOCCANTE	CONTRATUERCA
10	★Y704734	3/8"-16	1	LOCKNUT	COUVERCLE	DECKEL
11	★7883317	5/16"-18 X 1/2	1	SCREW	COPERCHIO	CUBIERTA
12	★700129686P		1	LEVER	BAGUE	BUCHSE
13	★827360		1	GRIP	BOCCOLA	CASQUILLO
14	★58644		1	SPRING	RESSORT	FEDER
15	★700138844P		1	SUPPORT	MOLLA	RESORTE
16	★70920415	3/8"-16 X 1-1/4	1	CAPSCREW	SUPPORT	LAGERUNG
16	★70917378	3/8"	1	FLAT WASHERS	SUPPORTO	DISPOS.DE SOSTEN
16	★700711238	3/8"-16	1	LOCKNUT	VIS BOUCHON	HUTSCHRAUBE
17	★700134935		1	LEVER	TAPPO A VITE	TORNILLO TAPON
18	★700113105P		1	ROD	ECROU BLOCCAGE	SICHERUNGSMUTTER
19	★6530588P		1	ARM	AUTOBLOCCANTE	CONTRATUERCA
20	★705541	1/2"	4	WASHER	LEVIER	HEBEL
21	★62174	5/32" X 1	2	PIN	LEVA	PALANCA
					TRINGLE	STANGE
					ASTA	VARILLA
					BRAS	ARM
					BRACCIO	BRAZO
					RONDELLE	UNTERLEGSCHIEBE
					RONDELLA	ARANDELA
					GOUPILLE	BOLZEN
					PERNO	PASADOR

Star Wheel
 Declencheur
 Strohrad
 Braccio Di Scatto
 Rueda Medicion

50-110 → HM 91460

5-BA33-012-A

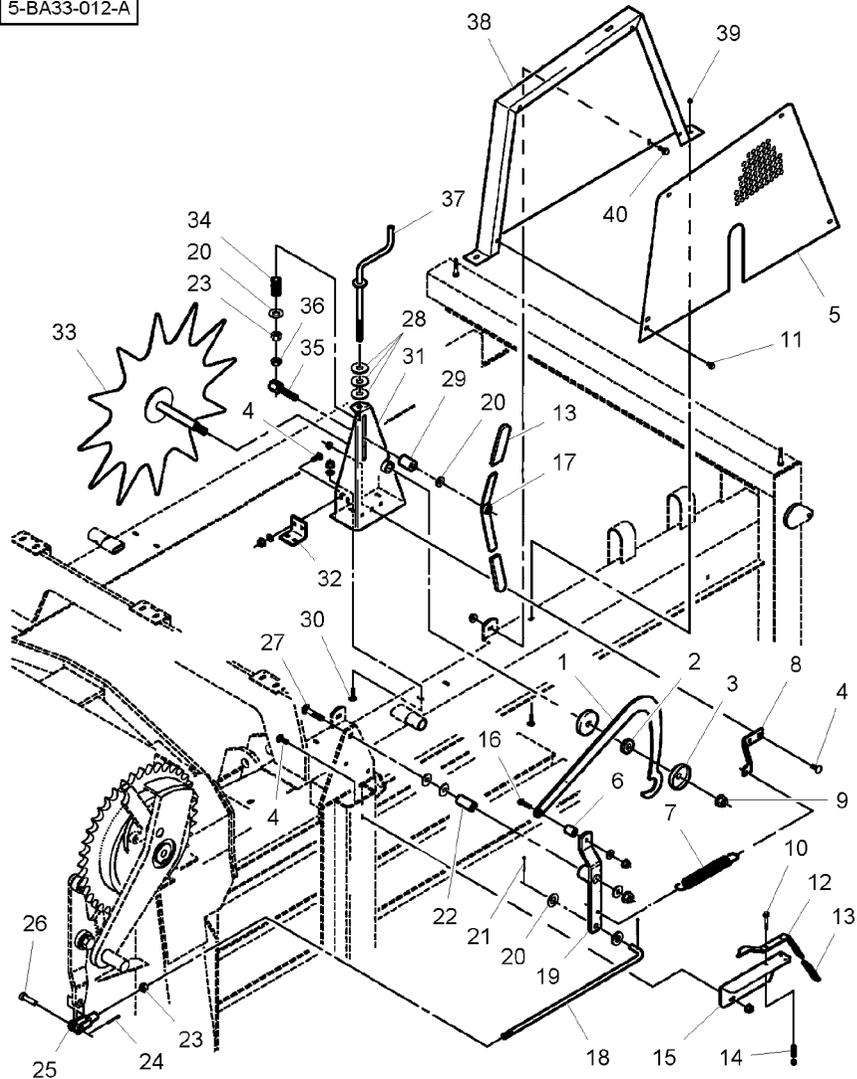

22★6530638P		1 BUSH	BAGUE	BUCHSE
23★704031	1/2"-13	2 NUT	BOCCOLA	CASQUILLO
24★70918452	1/8" X 1	1 PIN	ECROU	MUTTER
25★70937465		1 YOKE	DADO	TUERCA
26★70929593	1/2" X 1-1/2	1 PIN	GOUPILLE	BOLZEN
27★70927493	1/2"-13 X 2-1/2	1 BOLT	PERNO	PASADOR
27★700711557	1/2"	3 WASHER	CHAPE ARTICULAT	GELENKGABEL
27★700714586	1/2"-13	1 NUT	FORCELLA	YUGO
28★700711557	1/2"	3 WASHER	GOUPILLE	BOLZEN
29★6234710		1 SPACER	PERNO	PASADOR
30★70923220	3/8"-16 X 1-1/4	2 BOLT	BOULON	MASCH.SCHRAUBE
30★Y705533	3/8"	2 WASHER	BULLONE	ESPIGA/BULON
30★700711238	3/8"-16	2 LOCKNUT	RONDELLE	UNTERLEGSCHIEBE
31★700134931P		1 BRACKET	RONDELLE	ARANDELA
32★700134449P		1 ANGLE.	ECROU	MUTTER
33★6530307P		1 WHEEL	DADO	TUERCA
34★58024B		1 SPRING	RONDELLE	UNTERLEGSCHIEBE
35★700134527		1 SHAFT	RONDELLA	ARANDELA
36★704056	1/2"-13	1 NUT	ENTRETOISE	ABSTANDSTUECK
37★700134938		1 CRANK	DISTANZIALE	DISCO ESPACIADOR
38★700133656P		1 SHIELD	BOULON	MASCH.SCHRAUBE
39★7700578	5/16"-18 X 1	2 SCREW	BULLONE	ESPIGA/BULON
39★70931277	5/16"-18	2 NUT	RONDELLE	UNTERLEGSCHIEBE
40★7883325	5/16"-18 X 3/4	2 SCREW	RONDELLE	ARANDELA
40★70931277	5/16"-18	2 NUT	ECROU BLOCAGE	SICHERUNGSMUTTER
			AUTOBLOCCANTE	CONTRATUERCA
			SUPPORT FIXATION	HALTEAMM
			STAFFETTA	SOPORTE
			EQUERRE	WINKEL
			ANGOLO	ANGULO
			ROUE	RAD
			RUOTA	RUEDA
			RESSORT	FEDER
			MOLLA	RESORTE
			ARBRE	WELLE
			ALBERO	ARBOL
			ECROU	MUTTER
			DADO	TUERCA
			MANIVELLE	KURBEL
			MANOVELLA	MANIVELA
			TOLE	SCHILD
			RIPARO	BLINDAJE
			VIS	SCHRAUBE
			VITE	TORNILLO
			ECROU	MUTTER
			DADO	TUERCA
			VIS	SCHRAUBE
			VITE	TORNILLO
			ECROU	MUTTER
			DADO	TUERCA

Knotter
 Noueur
 Binder
 Legatore
 Anudadora

50-115

Reflector
 Catadioptré
 Rückstrahler
 Catadiottro
 Catafaros

5-BA06-005-B

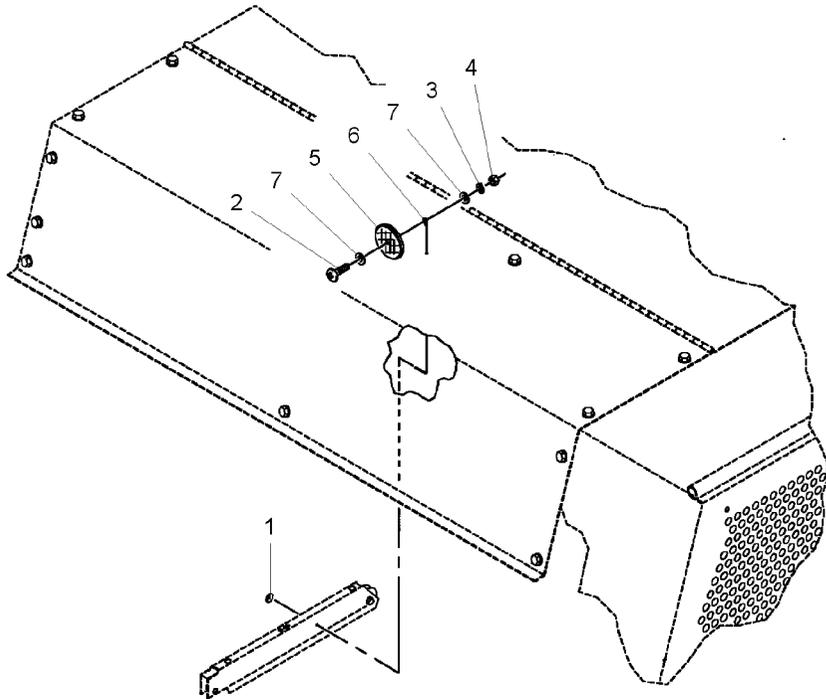

1	874404		6	NUT	ECROU	MUTTER
2	Y706549	No 10-24 X 3/4	6	SCREW	DADO	TUERCA
3	★705004	No 10	6	LOCK WASHER	VITE	SCHRAUBE
4	★354120X1	No 10-24	6	ROSETTA DENTELL.	ROSETTA DENTELL.	TORNILLO
5	8722894		6	NUT	ECROU	FEDERRING
6	700706503		6	REFLECTOR	DADO	ARANDELA GROWER
7	70917380	No 10	6	ROD	CATADIOPTRE	MUTTER
			6	WASHER	OJO DE GATO	REFLEKTOR
					TRINGLE	CATADIOPTRICO
					ASTA	STANGE
					RONDELLE	VARILLA
					RONDELLA	UNTERLEGSCHIEBE
						ARANDELA

Knotter
 Noueur
 Binder
 Legatore
 Anudadora

50-120

Kit - Up To 190lb-50214
 Kit - Jusqu' Au 190lb-50214
 Kit - Bis Den 190lb-50214
 Kit - Fino Alla 190lb-50214
 Kit - Hasta 190lb-50214

5-BA06-009-B

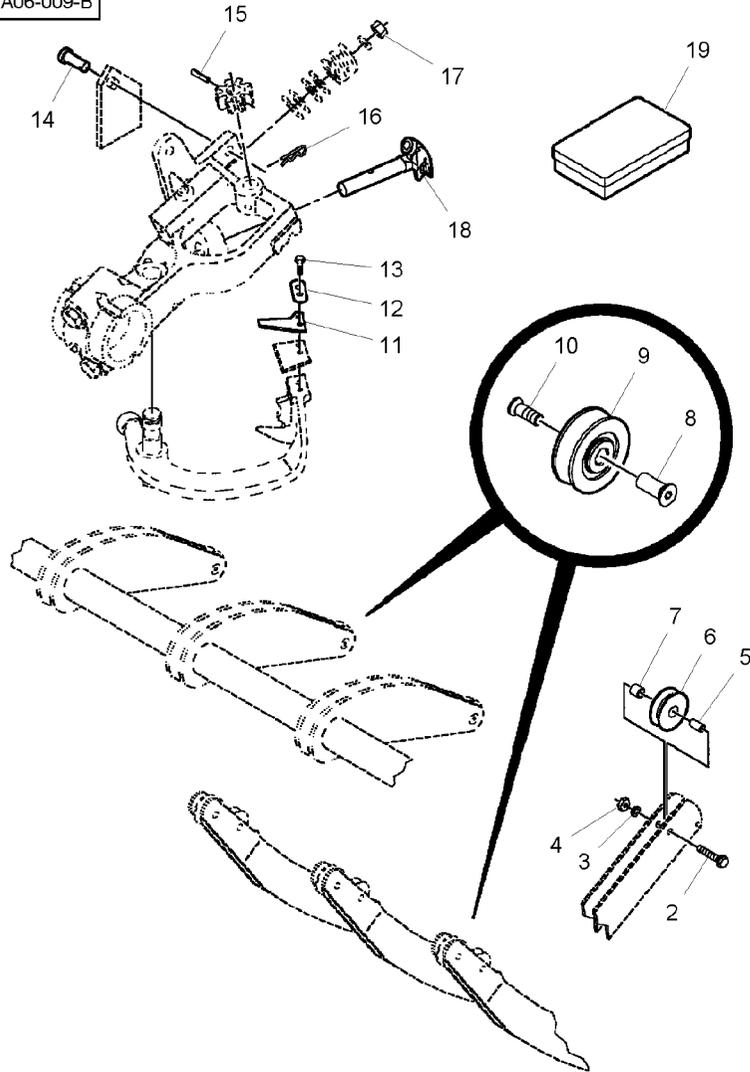

1	700114078	[A]	1	KIT, ATTACHMENT	JEU ACCESSOIRES KIT ACCESSORI	SATZ ANBAUTEILE JUEGO ACCESORIO
2	771345	1 No 10-24 X 1	1	CAPSCREW	VIS BOUCHON TAPPO A VITE	HUTSCHRAUBE TORNILLO TAPON
3	★705004	1 No 10	1	LOCK WASHER	RONDELLE FREIN ROSETTA DENTELL.	FEDERRING ARANDELA GROWER
4	★354120X1	1 No 10-24	1	NUT	ECROU DADO	MUTTER TUERCA
5	7849110	1	1	BUSH	BAGUE BOCCOLA	BUCHSE CASQUILLO
6	6529945	1	1	ROLLER	GALET RULLO	ROLLE RODILLO
7	7849656	1	1	SLEEVE	MANCHON MANICOTTO	HUELSE MANCHA
8	866566	1 No 10-32	1	FASTENER	AGRAFE LACCIO	HALTEKLAMMER CIERRE
9	700722661	1	1	BALL BEARING	ROULEMENT BILLES CUSCINETTO SFERE	KUGELLAGER COJINETE DE BOLA
10	8701476	1 No 10-32 X 1/2	1	CAPSCREW	VIS BOUCHON TAPPO A VITE	HUTSCHRAUBE TORNILLO TAPON
11	700715627	1 ➡ 190LB-50100	1	KNIFE	COUTEAU COLTELLO	MESSER CUCHILLA
11	700718710	1 ➡ 190LB-50101 ⚡ 1.5 MM	1	KNIFE	COUTEAU COLTELLO	MESSER CUCHILLA
12	6613624P	1	1	LOCKING PLATE	PLAQUE BLOCAGE PIASTRA DI FERMO	SICH.BLECH PLACA DE BLOCAJE
13	8701625	1 No 10-32 X 1/2	2	SCREW	VIS VITE	SCHRAUBE TORNILLO
14	63586	1 3/8" X 1-1/8	1	CLEVIS PIN	AXE PERNO D'ATTACCO	SPLINTBOLZEN BULON CILINDRICO
15	70922598	1 3/16" X 7/8	1	PIN	GOUILLE PERNO	BOLZEN PASADOR
16	98-2107	1 .149	1	PIN	GOUILLE PERNO	BOLZEN PASADOR
17	★70923434	1 3/8"-24	1	NUT	ECROU DADO	MUTTER TUERCA
18	700700968	1	1	KNOTTER	NOUEUR LEGATORE	BINDER ANUDADOR
19	700707474	1	1	BOX	BOITE SCATOLA	DOSE CAJA

[A] NOT ILLUSTRATED
 NON ILLUSTRATE
 NICHT ABGEBILDET
 NO ILLUSTRADO
 NO ILLUSTRATED

Knotter
 Noueur
 Binder
 Legatore
 Anudadora

50-125

Kit - From 190lb-50215
 Kit - A Partir Du 190lb-50215
 Kit - Ab Den 190lb-501215
 Kit - Dalla 190lb-50215
 Kit - A Partir Del 190lb-50215

5-BA06-017-C

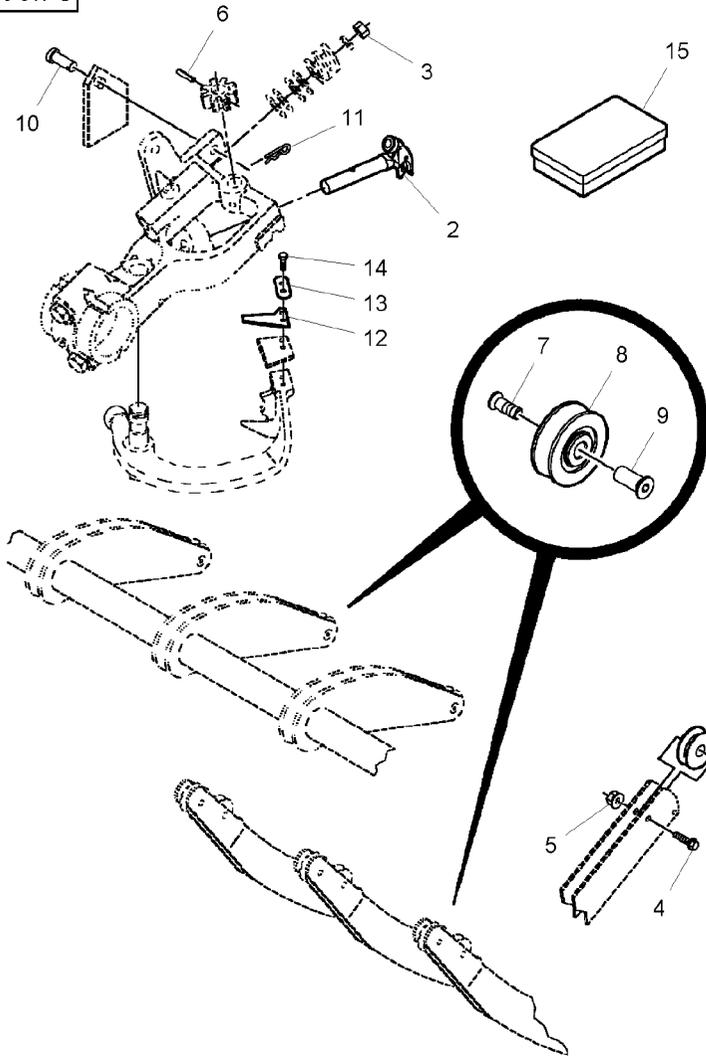

1	700150670	[A]	1 KIT, REPAIR
2	700700968	1	1 KNOTTER
3	70923434	1 3/8"-24	1 NUT
4	7883283	1 1/4"-20 X 1	1 SCREW
5	1703354	1 1/4"-20	1 NUT
6	70922598	1 3/16" X 7/8	1 PIN
7	8701476	1 No 10-32 X 1/2	1 CAPSCREW
8	700722661	1	1 BALL BEARING
9	866566	1 No 10-32	1 FASTENER
10	63586	1 3/8" X 1-1/8	1 CLEVIS PIN
11	98-2107	1	1 PIN
12	700718710	1 Δ 1,5 MM	1 KNIFE
13	6613624P	1	1 LOCKING PLATE
14	8701625	1 No 10-32 X 1/2	2 SCREW
15	700707474	1	1 BOX

JEU REPARATION	REPARATURSATZ
KIT RIPARAZIONE	JUEGO REPARACION
NOUEUR	BINDER
LEGATORE	ANUDADOR
ECROU	MUTTER
DADO	TUERCA
VITE	SCHRAUBE
ECROU	TORNILLO
DADO	MUTTER
GOUPILLE	TUERCA
PERNO	BOLZEN
VIS BOUCHON	PASADOR
TAPPO A VITE	HUTSCHRAUBE
ROULEMENT BILLES	TORNILLO TAPON
CUSCINETTO SFERE	KUGELLAGER
AGRAFE	COJINETE DE BOLA
LACCIO	HALTEKLAMMER
AXE	CIERRE
PERNO D'ATTACCO	SPLINTBOLZEN
GOUPILLE	BULON CILINDRICO
PERNO	BOLZEN
COUPEAU	PASADOR
COLTELLO	MESSER
PLAQUE BLOCAGE	CUCHILLA
PIASTRA DI FERMO	SICH.BLECH
VIS	PLACA DE BLOCAJE
VITE	SCHRAUBE
BOITE	TORNILLO
SCATOLA	DOSE
	CAJA

[A] NOT ILLUSTRATED
 NON ILLUSTRE
 NICHT ABGEBILDET
 NO ILLUSTRADO
 NO ILLUSTRATED

Lubrication
 Lubrification
 Schmieren
 Lubrificazione
 Engrase

50-130

5-BA16-014-B

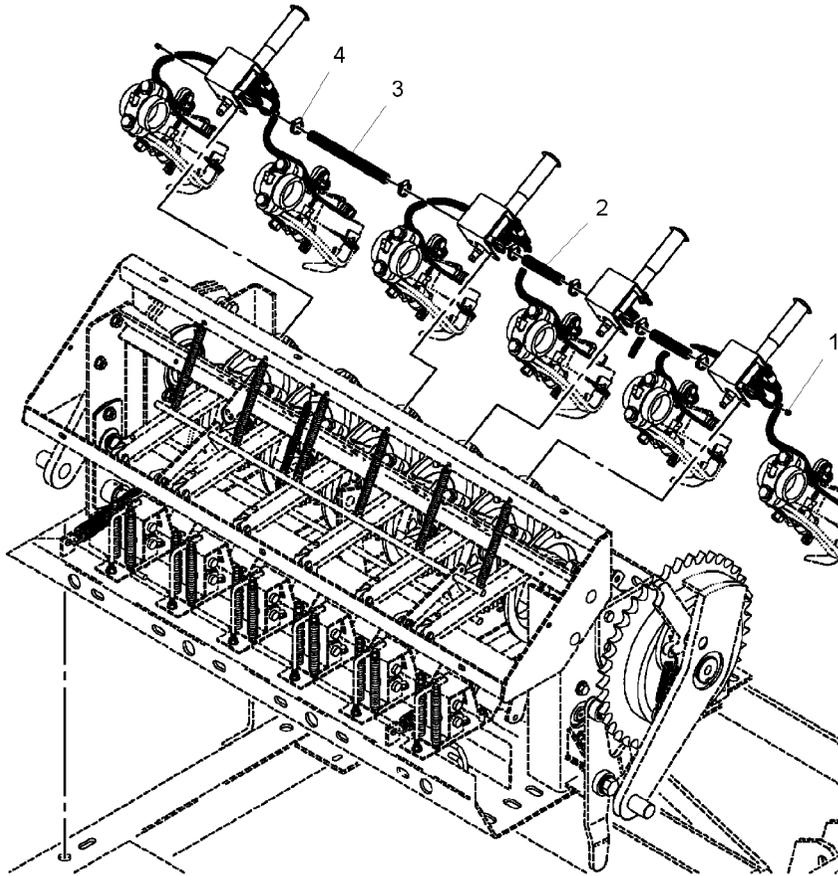

- 1 ★ Y46409 1/8"
- 2 ★ 700706281
- 3 ★ 700706282
- 4 ★ 7020019

- 2 PLUG
- 2 HOSE
- 1 HOSE
- 6 CLAMP

- BOUCHON
- TAPPO
- DURITE
- TUBO FLESSIBILE
- DURITE
- TUBO FLESSIBILE
- COLLIER
- FASCETTA

- VERSCHL.STOPFEN
- TAPON
- SCHLAUCH
- FLEXIBLE
- SCHLAUCH
- FLEXIBLE
- HALTESCHELLE
- ABRAZADERA

Lubrication
 Lubrification
 Schmierer
 Lubrificazione
 Engrase

50-135

5-BA16-015-C

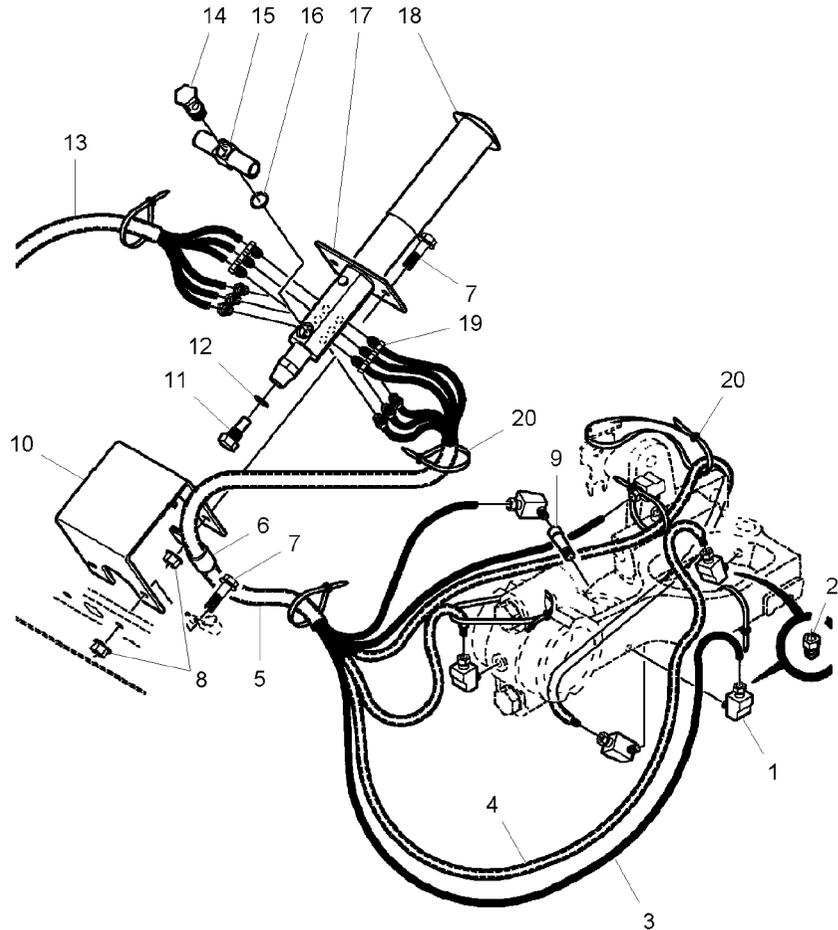

1	792259		36	ELBOW	COUDE GOMITO	WINKELSTUECK CODO
2	700706898	1	1	NUT	ECROU DADO	MUTTER TUERCA
3	700113359		1	TUBE	TUBE TUBO	ROHR TUBO
4	700113360		1	PROTECTIVE STRIP	GAINÉ PROTECTION GUAINA PROTETTIV	KANTENSCHUTZ BANDA PROTECTORA
5	700123362		1	PROTECTIVE STRIP	GAINÉ PROTECTION GUAINA PROTETTIV	KANTENSCHUTZ BANDA PROTECTORA
6	700711751		3	CLAMP	COLLIER FASCETTA	HALTESCHELLE ABRAZADERA
7	7883275	1/4"-20 X 3/4	12	SCREW	VIS VITE	SCHRAUBE TORNILLO
8	1703354	1/4"-20	12	NUT	ECROU DADO	MUTTER TUERCA
9	700706280		6	EXTENSION	RALLONGE PROLUNGA	VERLAENGERUNG ENSANCHE
10	700113353P		3	SUPPORT	SUPPORT SUPPORTO	LAGERUNG DISPOS.DE SOSTEN
11	700706539		3	PLUG	BOUCHON TAPPO	VERSCHL.STOPFEN TAPON
12	700706540		3	GASKET	JOINT GUARNIZIONE	DICHTSCHEIBE EMPAQUETADURA.
13	700123460		6	HARNESS	FAISCEAU FASCIOCAVI	KABELBAUM MAZO CABLES
14	700706543		3	STUD	GOUJON PRIGIONIERO	STEBBOLZEN CHAVETA ROSCADO
15	700706542		3	NIPPLE	GRAISSEUR COUDE NIPPLO	NIPPEL NIPLE
16	700706541		3	GASKET	JOINT GUARNIZIONE	DICHTSCHEIBE EMPAQUETADURA.
17	700113361P		3	PLATE	PLAQUE PIASTRA	PLATTE PLATO
18	700706276		3	PUMP	POMPE POMPA	PUMPE BOMBA
19	700706277		36	NUT	ECROU DADO	MUTTER TUERCA
20	70925094		36	TIE	ATTACHE TRAVERSA ATTACCO	KUPPL.STANGE BARRA DE ENLACE

Lubrication
 Lubrification
 Schmieren
 Lubrificazione
 Engrase

50-140

Feeder
 Ameneur
 Zubringer
 Infadatore
 Embocador

5-BA16-016-B

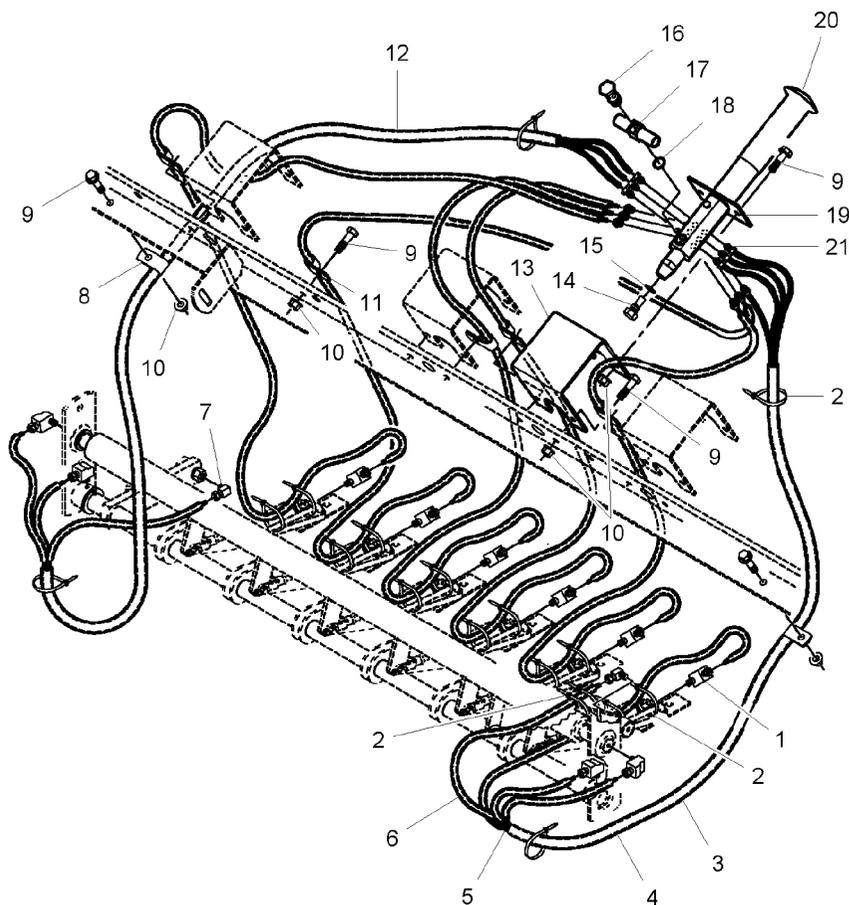

1	792259		10	ELBOW	COUDE	WINKELSTUECK
2	70925094		18	TIE	GOMITO	CODO
3	700123461	◀	1	HARNESS	ATTACHE	KUPPL.STANGE
4	700123362		1	PROTECTIVE STRIP	TRAVERSA ATTACCO	BARRA DE ENLACE
5	700113359		1	TUBE	FAISCEAU	KABELBAUM
6	700113360		1	PROTECTIVE STRIP	FASCIOCAVI	MAZO CABLES
7	700706279		1	PROTECTIVE STRIP	GAINE PROTECTION	KANTENSCHUTZ
8	700711751		1	TUBE	GUAINA PROTETTIV	BANDA PROTECTORA
9	7883275	1/4"-20 X 3/4	1	TUBE	TUBE	ROHR
10	1703354	1/4"-20	1	PROTECTIVE STRIP	TUBO	TUBO
11	70926919		1	PROTECTIVE STRIP	GAINE PROTECTION	KANTENSCHUTZ
12	700122683	▶	1	PROTECTIVE STRIP	GUAINA PROTETTIV	BANDA PROTECTORA
13	700113353P		2	COUPLER	ACCOUPEMENT	KUPPLUNGSSTUECK
14	700706539		2	CLAMP	ACCOPIATORE	ACOPLADOR
15	700706540		2	CLAMP	COLLIER	HALTESCHELLE
16	700706543		7	SCREW	FASCETTA	ABRAZADERA
17	700706542		7	SCREW	VIS	SCHRAUBE
18	700706541		7	NUT	VITE	TORNILLO
19	700113361P		7	NUT	ECROU	MUTTER
20	700706276		5	CLAMP	DADO	TUERCA
21	700706277		1	CLAMP	COLLIER	HALTESCHELLE
			1	HARNESS	FASCETTA	ABRAZADERA
			1	SUPPORT	FAISCEAU	KABELBAUM
			1	SUPPORT	FASCIOCAVI	MAZO CABLES
			1	PLUG	SUPPORT	LAGERUNG
			1	GASKET	SUPPORTO	DISPOS.DE SOSTEN
			1	STUD	BOUCHON	VERSCHL.STOPFEN
			1	NIPPLE	TAPPO	TAPON
			1	GASKET	JOINT	DICHTSCHEIBE
			1	PLATE	GUARNIZIONE	EMPAQUETADURA.
			1	PUMP	GOUJON	STEBBOLZEN
			12	NUT	PRIGIONIERO	CHAVETA ROSCADO
					GRAISSEUR COUDE	NIPPEL
					NIPPLO	NIPPEL
					JOINT	DICHTSCHEIBE
					GUARNIZIONE	EMPAQUETADURA.
					PLAQUE	PLATTE
					PIASTRA	PLATO
					POMPE	PUMPE
					POMPA	BOMBA
					ECROU	MUTTER
					DADO	TUERCA

Lubrication
 Lubrification
 Schmierer
 Lubrificazione
 Engrase

50-145

Front
 Avant
 Vorne
 Anteriore
 Delantero

5-BA16-018-B

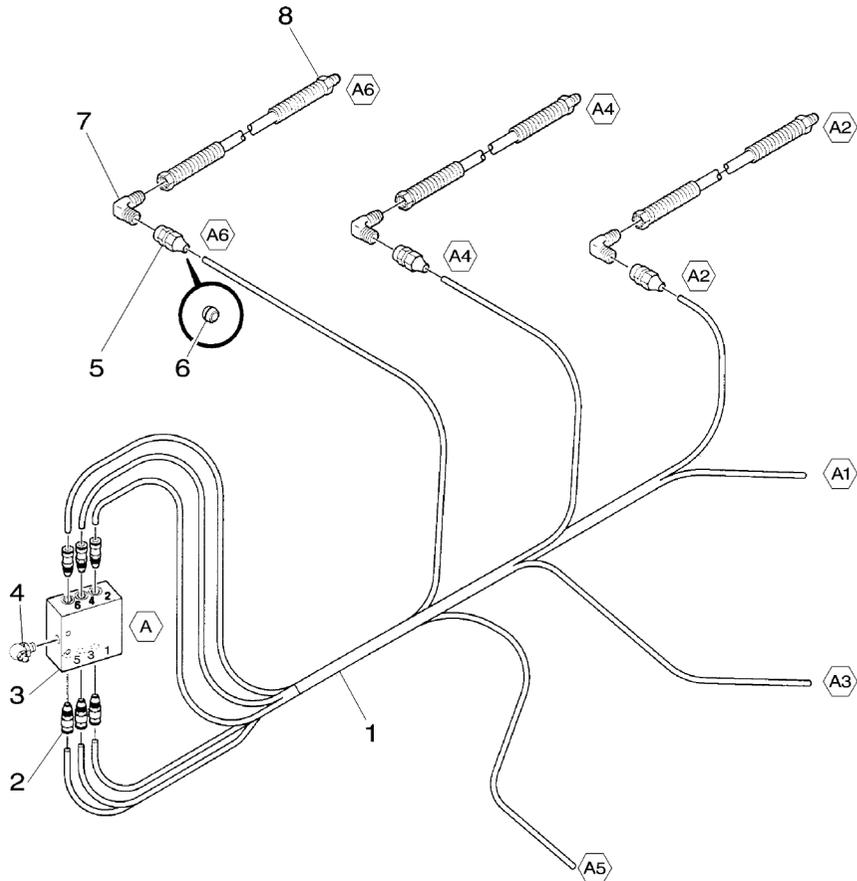

- 1 700113687
- 2 700714008
- 3 700706835
- 4 **70915276** 1/8"-27 X 90°
- 5 700706840
- 6 700706679 5
- 7 70919173
- 8 **700706798**

1 TUBE ASSY	ENSEMBLE TUBE TUBO COMPL.	ROHR KPL CONJ.DE TUBO
12 FITTING	MONTAGE RACCORDO.	ANSHL.VERSCHRBG ACCESORIO.
1 VALVE.	SOUPAPE VALVOLA	VENTIL VALVULA
1 NIPPLE	GRAISSEUR COUDE NIPPLO	NIPPEL NIPLE
3 CONNECTOR	BORNE MORSETTO	DOPPELNIPPEL CONECTOR
3 SLEEVE	MANCHON MANICOTTO	HUELSE MANCHA
3 ELBOW	COUDE GOMITO	WINKELSTUECK CODO
3 HOSE	DURITE TUBO FLESSIBILE	SCHLAUCH FLEXIBLE

Lubrification
 Lubrification
 Schmieren
 Lubrificazione
 Engrase

50-150

Right Rear
 Arriere Droit
 Hinten Recht
 Posteriore Destra
 Trasero Derecho

5-BA16-019-B

- 1 ★ 700113890
- 2 ★ 700714008
- 3 ★ 700706835
- 4 ★ 700706841
- 5 ★ 700706839
- 6 ★ 70915276

1/8"-27 X 90°

- 1 HARNESS
- 5 FITTING
- 1 VALVE.
- 1 PLUG
- 1 GASKET
- 1 NIPPLE

FAISCEAU
 FASCIOCAVI
 MONTAGE
 RACCORDO.
 SOUPAPE
 VALVOLA
 BOUCHON
 TAPPO
 JOINT
 GUARNIZIONE
 GRAISSEUR COUDE
 NIPPLO

KABELBAUM
 MAZO CABLES
 ANSCHL.VERSCHRBG
 ACCESSORIO.
 VENTIL
 VALVULA
 VERSCHL.STOPFEN
 TAPON
 DICHTSCHEIBE
 EMPAQUETADURA.
 NIPPEL
 NIPLE

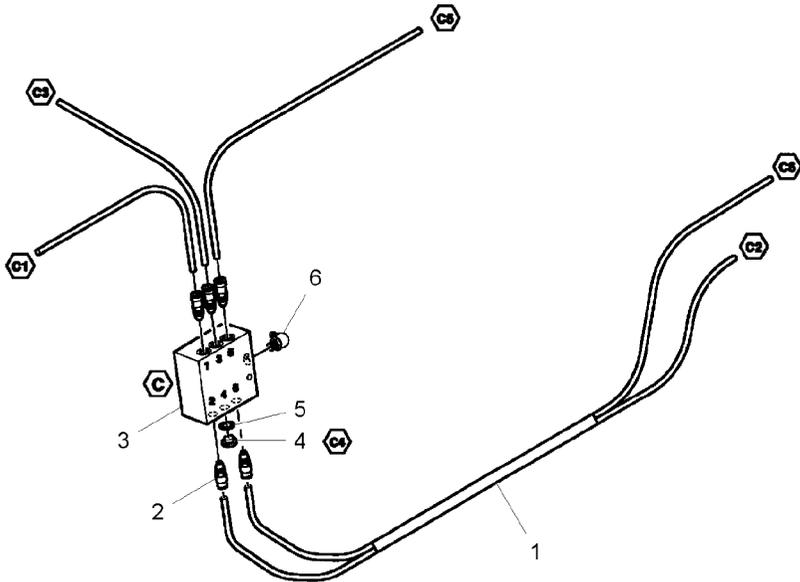

Lubrification
 Lubrification
 Schmierer
 Lubrificazione
 Engrase

50-155

Left Rear
 Arriere Gauche
 Hinten Links
 Posteriore Sinistro
 Trasero Izquierdo

5-BA16-020-B

1 ★700113690

1 HARNESS

FAISCEAU
 FASCIOCAVI

KABELBAUM
 MAZO CABLES

2 ★700706837

1 VALVE.

SOUPAPE
 VALVOLA

VENTIL
 VALVULA

3 ★700714008

8 FITTING

MONTAGE
 RACCORDO.

ANSCHL.VERSCHRBG
 ACCESORIO.

4 ★70915276

1/8"-27 X 90°

1 NIPPLE

GRAISSEUR COUDE
 NIPPLIO

NIPPEL
 NIPLE

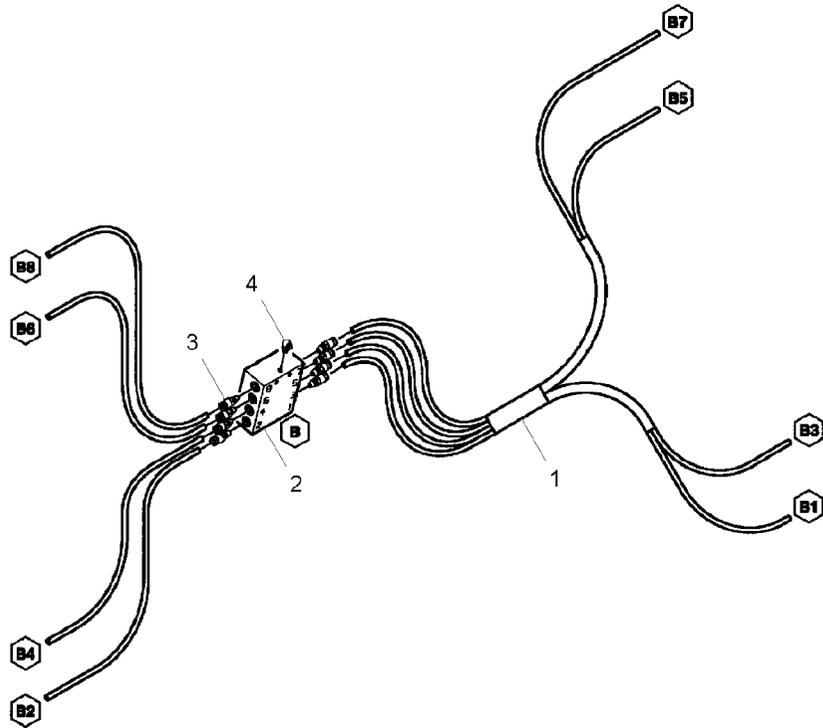

Lubrication
 Lubrification
 Schmierer
 Lubrificazione
 Engrase

50-160

5-BA16 008 A

- 1 700706843
- 2 700706679
- 3 700113862
- 4 70925094

◀▶ 1585 MM

- 1 UNION
- 1 SLEEVE
- 1 HOSE
- 5 TIE

RACCORD
 RACCORDO
 MANCHON
 MANICOTTO
 DURITE
 TUBO FLESSIBILE
 ATTACHE
 TRAVERSA ATTACCO

VERSCHRAUBUNG
 RACOR
 HUELSE
 MANCHA
 SCHLAUCH
 FLEXIBLE
 KUPPL.STANGE
 BARRA DE ENLACE

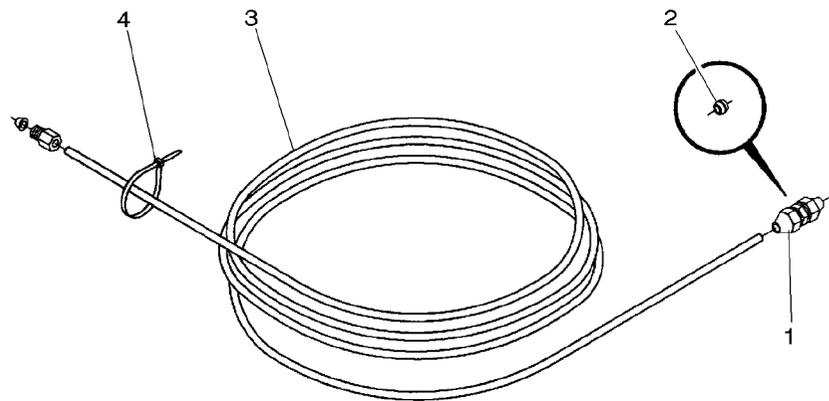

Lubrication
 Lubrification
 Schmierer
 Lubrificazione
 Engrase

50-165

Tank- Up To Serial 190lb-50100
 Reservoir - Jusqu Au 190lb-50100
 Behälter - Bis Serien 190lb-50100
 Serbatoio - Fimo Alla 190lb-50100
 Deposito - Hasta 190lb-50100

5-BA16-007-C

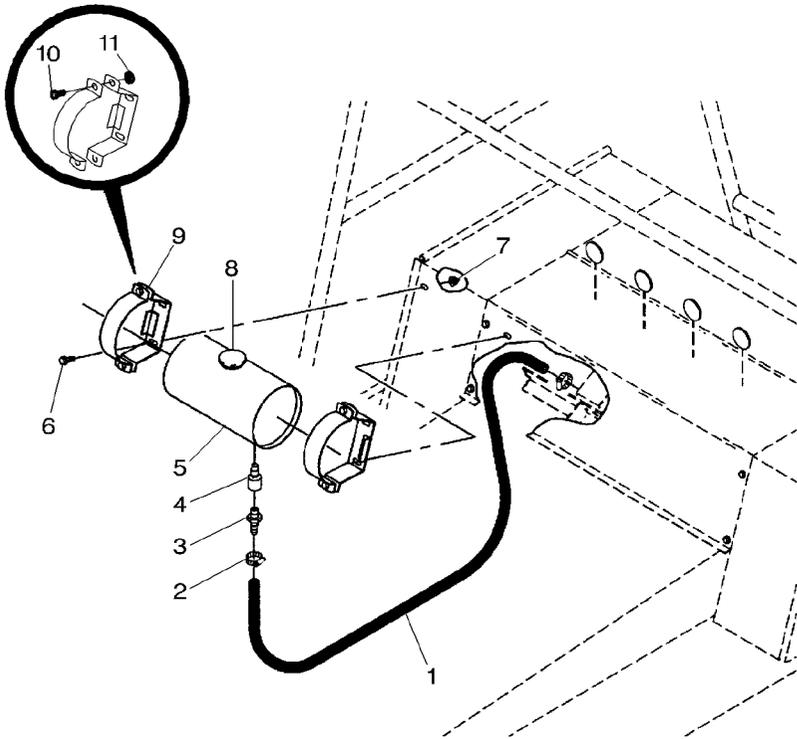

1	700706284		1	HOSE	DURITE	SCHLAUCH
2	7020019		2	CLAMP	TUBO FLESSIBILE	FLEXIBLE
3	846915		1	INSERT	COLLIER	HALTESCHELLE
4	700706288		1	ADAPTOR	FASCETTA	ABRAZADERA
5	700706285		1	TANK	DOUILLE	EINSATZSTUECK
6	7703424	3/8"-16 X 1	2	CAPSCREW	INSERTO	INSERCIÓN
7	704247	3/8"-16	1	ADAPTOR	ADAPTATEUR	REDUZIERNIPPEL
8	700715459	5	1	TANK	ADATTATORE	ADAPTADOR
9	700706287		1	TANK	RESERVOIR	TANK
10	353693X1	9 3/8"-16 X 1-1/4	2	CAPSCREW	SERBATOIO	DEPOSITO LIQUIDO
11	7704141	9 3/8"-16	2	NUT	VIS BOUCHON	HUTSCHRAUBE
			2	NUT	TAPPO A VITE	TORNILLO TAPON
			1	CAP	ECROU	MUTTER
			1	SUPPORT	DADO	TUERCA
			4	SCREW UNC	CHAPEAU	KAPPE
			4	LOCKNUT	CAPUCHON	TAPA
					SUPPORT	LAGERUNG
					SUPPORTO	DISPOS.DE SOSTEN
					VIS UNC	SCHRAUBE UNC
					VITE UNC	TORNILLO UNC
					ECROU BLOCAGE	SICHERUNGSMUTTER
					AUTOBLOCCANTE	CONTRATUERCA

Lubrication
 Lubrification
 Schmierer
 Lubrificazione
 Engrase

50-170

Tank - From 190lb-50101
 Reservoir - A Partir Du 190lb-50101
 Behälter - Ab Den 190lb-50101
 Serbatoio - Dalla 190lb-50101
 Deposito - A Partir Del 190lb-50101

5-BA16-034-B

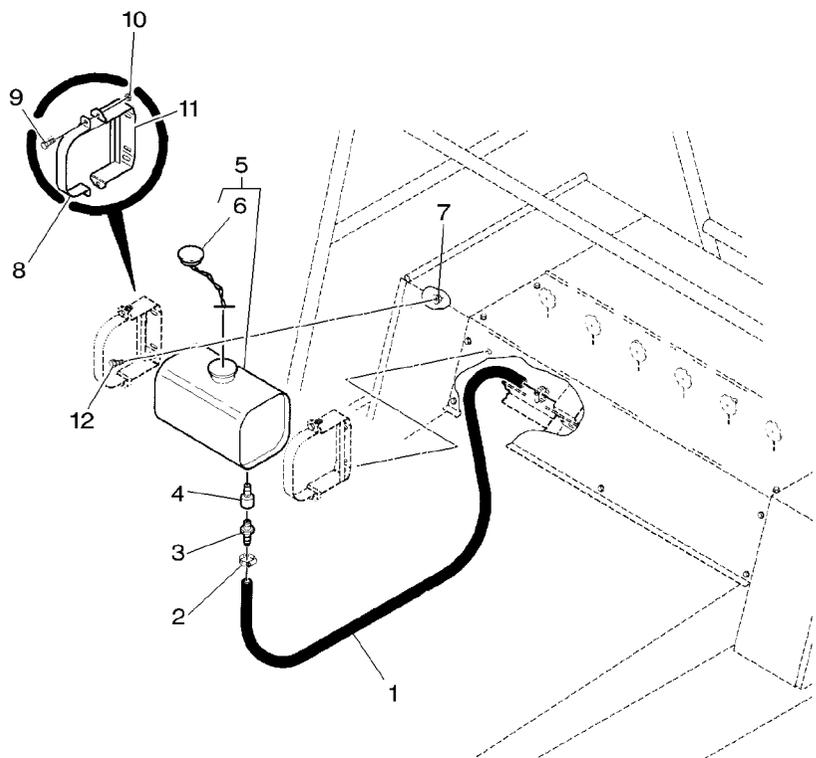

1	700706284		1	HOSE	DURITE	SCHLAUCH
2	7020019		2	CLAMP	TUBO FLESSIBILE	FLEXIBLE
3	846915		1	INSERT	COLLIER	HALTESCHELLE
4	700706288		1	ADAPTOR	FASCETTA	ABRAZADERA
5	700715415		1	OIL TANK	DOUILLE	EINSATZSTUECK
6	700715459	5	1	CAP	INSERTO	INSERCIÓN
7	704247	3/8"-16	1	ADAPTATEUR	ADATTATORE	REDUZIERNIPPEL
8	700129435P		1	ADATTATORE	RESERVOIR HUILE	ADAPTADOR
9	*70920415	3/8"-16 X 1-1/4	1	RESERVOIR HUILE	SERBATOIO OLIO	OELBEHAELTER
10	7704141	3/8"-16	1	SERBATOIO OLIO	DEPOSITO ACEITE	DEPOSITO ACEITE
11	700129433B		1	CHAPEAU	CHAPEAU	KAPPE
12	7703424	3/8"-16 X 1	2	CAPUCHON	ECROU	TAPA
			2	ECROU	DADO	MUTTER
			2	STRAP	PATTE	TUERCA
			4	CAPSCREW	CORREGGIA	LASCHE
			4	LOCKNUT	VIS BOUCHON	FAJA
			2	SUPPORT	TAPPO A VITE	HUTSCHRAUBE
			2	CAPSCREW	ECROU BLOCAGE	TORNILLO TAPON
					AUTOBLOCCANTE	SICHERUNGSMUTTER
					SUPPORTO	CONTRATUERCA
					VIS BOUCHON	LAGERUNG
					TAPPO A VITE	DISPOS.DE SOSTEN
						HUTSCHRAUBE
						TORNILLO TAPON

Lubrication
 Lubrification
 Schmieren
 Lubrificazione
 Engrase

50-175

Hydraulic Lines - Up To 190lb-50214
 Tuyauteries - Jusqu'au 190lb-50214
 Leitungen - Bis Den 190lb-50214
 Tubazioni - Fino Alla 190lb-50214
 Circuito - Hasta 190lb-50214

5-BA16-017-D

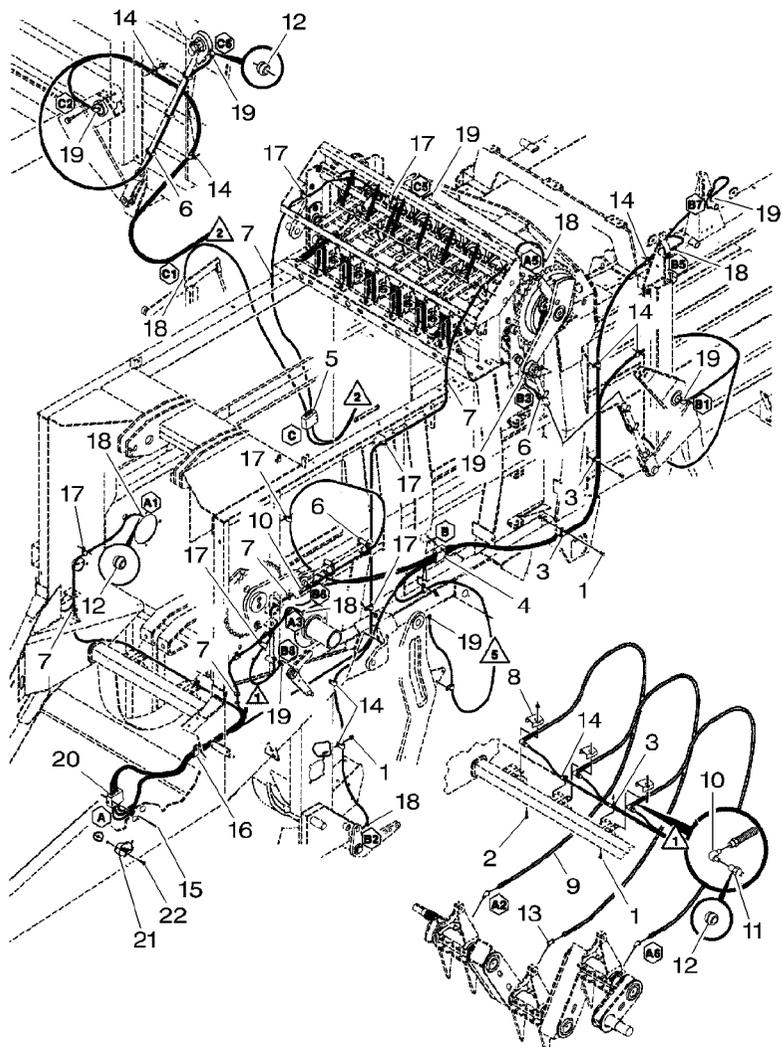

1	★70921965	3/8"-16 X 3/4	16	CAPSCREW	VIS BOUCHON	HUTSCHRAUBE
1	Y704734	3/8"-16	16	LOCKNUT	TAPPO A VITE	TORNILLO TAPON
2	★70921969	3/18"-16 X 1-1/2			ECROU BLOCAGE	SICHERUNGSMUTTER
2	Y704734	3/8"-16	3	CAPSCREW	AUTOBLOCCANTE	CONTRATUERCA
3	70926049	3/4"	3	LOCKNUT	VIS BOUCHON	HUTSCHRAUBE
4	700113690		5	CLAMP	TAPPO A VITE	TORNILLO TAPON
5	700113890				ECROU BLOCAGE	SICHERUNGSMUTTER
6	70921911		1	HARNESS	AUTOBLOCCANTE	CONTRATUERCA
7	7827561		5	CLAMP	COLLIER	HALTESCHELLE
8	700113671P		1	HARNESS	FASCETTA	ABRAZADERA
9	700706798		8	CLAMP	FAISCEAU	KABELBAUM
10	70919173		1	HARNESS	FASCIOCAVI	MAZO CABLES
11	700706840		1	HARNESS	FASCIOCAVI	KABELBAUM
12	700706679		8	CLAMP	FASCIOCAVI	MAZO CABLES
13	70920655	1/8"-27 X 45°	5	GROMMET	COLLIER	HALTESCHELLE
14	70925617	1/2"	3	CLAMP	FASCETTA	ABRAZADERA
15	7701444	No 10-32 X 1-3/4	3	HOSE	PASSE FIL	GUMMITUELLE
15	Y704445	No 10-32	3	ELBOW	ANELLO PASSACAVO	PASACABLE
16	70929160	1"	3	CONNECTOR	COLLIER	HALTESCHELLE
17	70928654	1/4"	3	HOSE	FASCETTA	ABRAZADERA
18	700706683		3	ELBOW	DURITE	SCHLAUCH
19	700706682	1/8"-27 X 90°	3	CONNECTOR	TUBO FLESSIBILE	FLEXIBLE
20	700113687		3	ELBOW	COUDE	WINKELSTUECK
21	700707011		3	CONNECTOR	GOMITO	CODO
22	★70923114	1/2"-13 X 1	3	CONNECTOR	BORNE	DOPPELNIPPEL
22	Y704742	1/2"-13	19	SLEEVE	MORSETTO	CONECTOR
			19	SLEEVE	MANCHON	HUELSE
			19	SLEEVE	MANICOTTO	MANCHA
			19	SLEEVE	COUDE	WINKELSTUECK
			19	SLEEVE	GOMITO	CODO
			19	SLEEVE	COLLIER	HALTESCHELLE
			19	SLEEVE	FASCETTA	ABRAZADERA
			19	SLEEVE	VIS	SCHRAUBE
			19	SLEEVE	VITE	TORNILLO
			19	SLEEVE	ECROU	MUTTER
			19	SLEEVE	DADO	TUERCA
			19	SLEEVE	COLLIER	HALTESCHELLE
			19	SLEEVE	FASCETTA	ABRAZADERA
			19	SLEEVE	COLLIER	HALTESCHELLE
			19	SLEEVE	FASCETTA	ABRAZADERA
			19	SLEEVE	BORNE	DOPPELNIPPEL
			19	SLEEVE	MORSETTO	CONECTOR
			19	SLEEVE	COUDE	WINKELSTUECK
			19	SLEEVE	GOMITO	CODO
			19	SLEEVE	ENSEMBLE TUBE	ROHR KPL
			19	SLEEVE	TUBO COMPL.	CONJ.DE TUBO
			19	SLEEVE	PIECE SUPPORT	HALTER
			19	SLEEVE	SUPPORTO DI BASE	SUJETADOR
			19	SLEEVE	VIS BOUCHON	HUTSCHRAUBE
			19	SLEEVE	TAPPO A VITE	TORNILLO TAPON
			19	SLEEVE	ECROU BLOCAGE	SICHERUNGSMUTTER
			19	SLEEVE	AUTOBLOCCANTE	CONTRATUERCA

Lubrification
 Lubrification
 Schmierer
 Lubrificazione
 Engrase

50-180

Hydraulic Lines - From 190lb-50215 - Up To H.P 91215
 Tuyauteries - A Partir Du 190lb-50215 - Jusqu' Au H.P 91215
 Leitungen - Ab Den 190lb-50215 - Bis H.P 91215
 Tubazioni - Dalla 190lb-50215 - Fino Alla H.P 91215
 Circuito - A Partir Del 190lb-50215 - Hasta H.P 91215

5-BA16-042-A

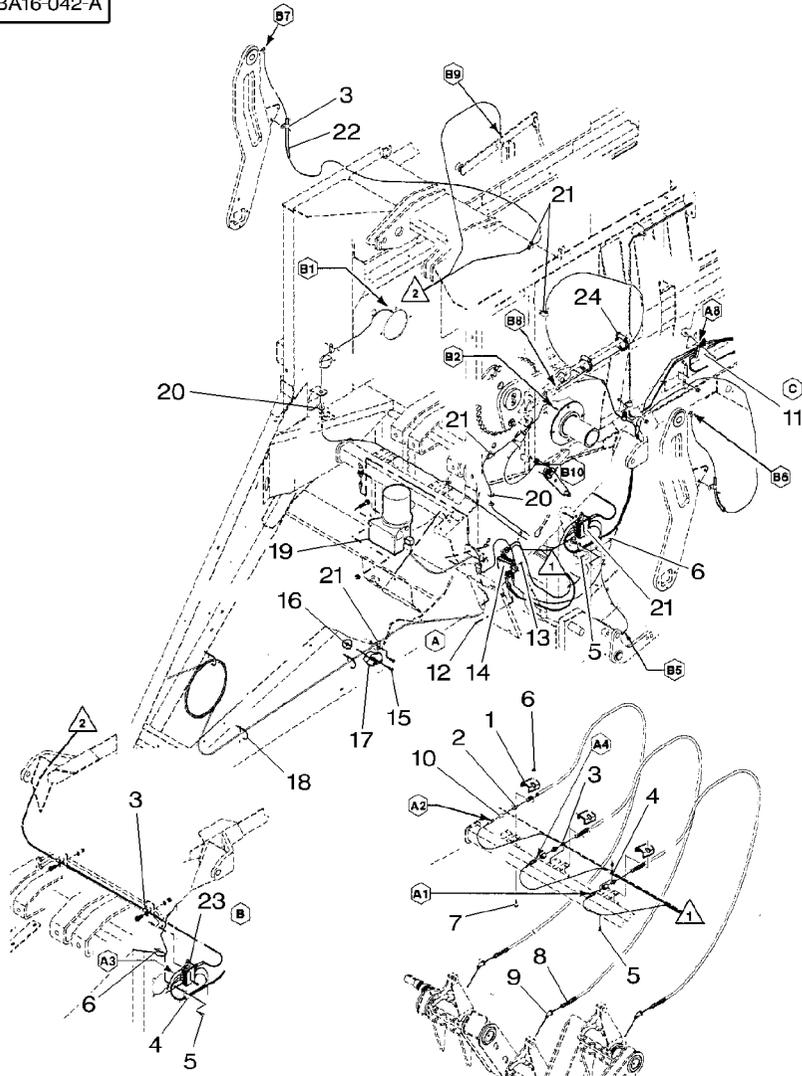

1	700113671P		3	CLAMP	COLLIER	HALTESCHELLE
2	70919171		3	UNION	FASCETTA	ABRAZADERA
3	70925617	1/2"	10	CLAMP	RACCORD	VERSCHRAUBUNG
4	70926049	3/4"	2	CLAMP	RACCORDO	RACOR
5	★70921965	3/8"-16 X 3/4	13	CAPSCREW	COLLIER	HALTESCHELLE
6	Y704734	3/8"-16	2	CLAMP	FASCETTA	ABRAZADERA
7	★70921969	3/8"-16 X 1-1/2	13	CAPSCREW	FASCETTA	ABRAZADERA
8	700706798		19	LOCKNUT	VIS BOUCHON	HUTSCHRAUBE
9	70920655	1/8"-27 X 45°	19	LOCKNUT	TAPPO A VITE	TORNILLO TAPON
10	70901763		3	CAPSCREW	ECROU BLOCAGE	SICHERUNGSMUTTER
11	700718111	👁 50-205 No 1	3	CAPSCREW	AUTOBLOCCANTE	CONTRATUERCA
12	7701444	No 10-32 X 1-3/4	3	HOSE	VIS BOUCHON	HUTSCHRAUBE
13	Y704445	No 10-32	3	HOSE	TAPPO A VITE	TORNILLO TAPON
14	700718112	👁 50-210 No 1	3	ELBOW	DURITE	SCHLAUCH
15	★70923114	1/2"-13 X 1	3	ELBOW	TUBO FLESSIBILE	FLEXIBLE
16	Y704742	1/2"-13	3	ELBOW	COUDE	WINKELSTUECK
17	700707011		3	UNION	GOMITO	CODO
18	70925094		3	UNION	RACCORD	VERSCHRAUBUNG
19	700720087	➡ HN 91100	1	HARNESS	RACCORDO	RACOR
19	★700725825	👁 50-195 No 1	1	HARNESS	FAISCEAU	KABELBAUM
20	7827561	➡ HN 91101	6	SCREW	FASCIOCAVI	MAZO CABLES
21	70928654	👁 50-195 No 1	6	NUT	VIS	SCHRAUBE
22	700720109		1	HARNESS	VITE	TORNILLO
23	700718110	👁 50-200 No 1	1	HARNESS	ECROU	MUTTER
24	70921911		1	HARNESS	DADO	TUERCA
			1	HARNESS	FAISCEAU	KABELBAUM
			1	CAPSCREW	FASCIOCAVI	MAZO CABLES
			1	LOCKNUT	VIS BOUCHON	HUTSCHRAUBE
			1	LOCKNUT	TAPPO A VITE	TORNILLO TAPON
			1	HOLDER	ECROU BLOCAGE	SICHERUNGSMUTTER
			1	HOLDER	AUTOBLOCCANTE	CONTRATUERCA
			3	TIE	PIECE SUPPORT	HALTER
			1	PUMP	SUPPORTO DI BASE	SUJETADOR
			1	PUMP	ATTACHE	KUPPL.STANGE
			1	PUMP	TRAVERSA ATTACCO	BARRA DE ENLACE
			3	GROMMET	POMPE	PUMPE
			8	CLAMP	POMPA	BOMBA
			2	HOSE	POMPE	PUMPE
			2	HOSE	POMPA	BOMBA
			1	HARNESS	PASSE FIL	GUMMITUELLE
			2	CLAMP	ANELLO PASSACAVO	PASACABLE
			1	HARNESS	COLLIER	HALTESCHELLE
			2	CLAMP	FASCETTA	ABRAZADERA
			1	HARNESS	DURITE	SCHLAUCH
			2	CLAMP	TUBO FLESSIBILE	FLEXIBLE
			1	HARNESS	FAISCEAU	KABELBAUM
			2	CLAMP	FASCIOCAVI	MAZO CABLES
			1	HARNESS	COLLIER	HALTESCHELLE
			2	CLAMP	FASCETTA	ABRAZADERA

Lubrication
 Lubrification
 Schmierer
 Lubrificazione
 Engrase

50-185

Hydraulic Lines - From H.P 91216
 Tuyauteries - A Partir Du H.P 91216
 Leitungen - Ab Den H.P 91216
 Tubazioni - Dalla H.P 91216
 Circuito - A Partir Del H.P 91216

5-BA16-079-A

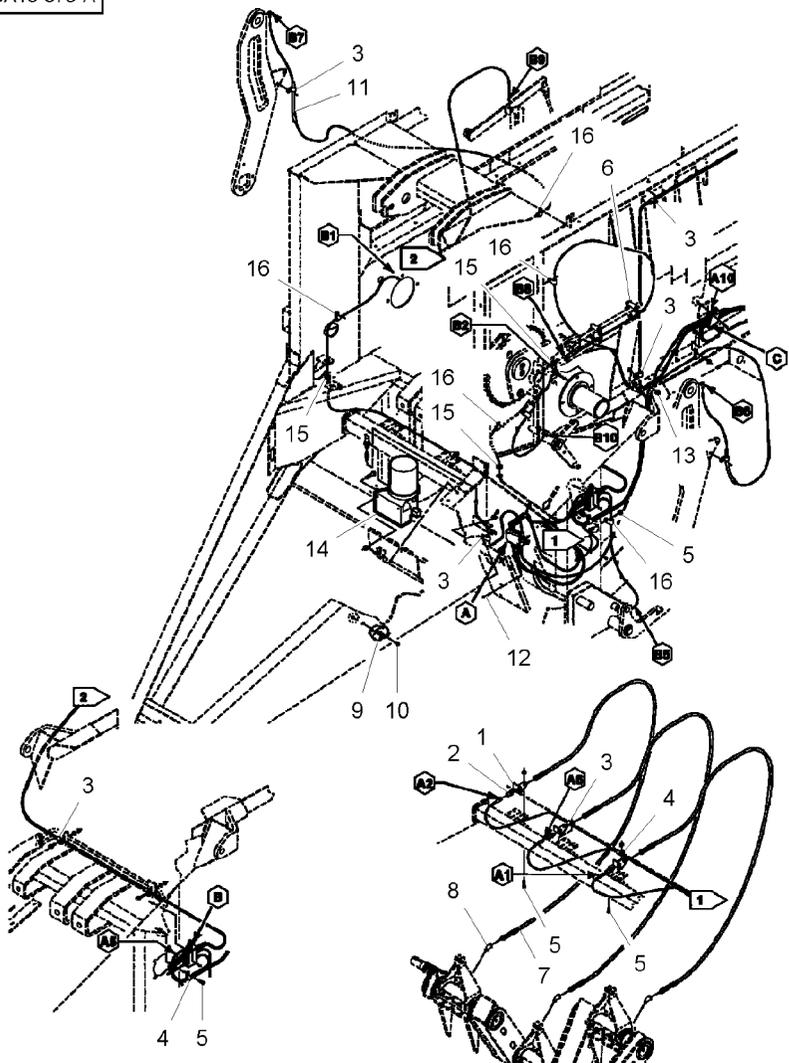

1	★700163719		3	SUPPORT	SUPPORT	LAGERUNG
2	★700723840		3	UNION	SUPPORTO	DISPOS.DE SOSTEN
3	★70925617	1/2"	3	UNION	RACCORD	VERSCHRAUBUNG
4	★70926049	3/4"	10	CLAMP	RACCORDO	RACOR
5	★70921965	3/8"-16 X 3/4	10	CLAMP	COLLIER	HALTESCHELLE
5	★Y704734	3/8"-16	2	CLAMP	FASCETTA	ABRAZADERA
6	★70921911		2	CLAMP	FASCETTA	HALTESCHELLE
7	★700706798		16	CAPSCREW	VIS BOUCHON	HUTSCHRAUBE
8	★70920655	1/8"-27 X 45°	16	LOCKNUT	TAPPO A VITE	TORNILLO TAPON
9	★700707011		16	LOCKNUT	ECROU BLOCAGE	SICHERUNGSMUTTER
10	★70923114	1/2"-13 X 1	2	CLAMP	AUTOBLOCCANTE	CONTRATUERCA
10	★Y704742	1/2"-13	2	CLAMP	COLLIER	HALTESCHELLE
11	★700720109		3	HOSE	FASCETTA	ABRAZADERA
12	★7701444	No 10-32 X 1-3/4	3	HOSE	DURITE	SCHLAUCH
12	★Y704445	No 10-32	3	ELBOW	TUBO FLESSIBILE	FLEXIBLE
13	★Y704734	3/8"-16	3	ELBOW	COUDE	WINKELSTUECK
14	★700725825	👁 50-195 No 1	1	HOLDER	GOMITO	CODO
15	★7827561		1	HOLDER	PIECE SUPPORT	HALTER
16	★70928654	1/4"	1	CAPSCREW	SUPPORTO DI BASE	SUJETADOR
			1	CAPSCREW	VIS BOUCHON	HUTSCHRAUBE
			1	LOCKNUT	TAPPO A VITE	TORNILLO TAPON
			1	LOCKNUT	ECROU BLOCAGE	SICHERUNGSMUTTER
			2	HOSE	AUTOBLOCCANTE	CONTRATUERCA
			2	HOSE	DURITE	SCHLAUCH
			6	SCREW	TUBO FLESSIBILE	FLEXIBLE
			6	NUT	VIS	SCHRAUBE
			6	NUT	VITE	TORNILLO
			6	LOCKNUT	ECROU	MUTTER
			6	LOCKNUT	DADO	TUERCA
			6	LOCKNUT	ECROU BLOCAGE	SICHERUNGSMUTTER
			1	PUMP	AUTOBLOCCANTE	CONTRATUERCA
			1	PUMP	POMPE	PUMPE
			3	GROMMET	POMPA	BOMBA
			3	GROMMET	PASSE FIL	GUMMITUELLE
			7	CLAMP	ANELLO PASSACAVO	PASACABLE
			7	CLAMP	COLLIER	HALTESCHELLE
			7	CLAMP	FASCETTA	ABRAZADERA

Lubrication
 Lubrification
 Schmierer
 Lubrificazione
 Engrase

50-190

Hydraulic Lines - From 190lb-50215
 Tuyauteries - A Partir Du 190lb-50215
 Leitungen - Ab Den 190lb-50215
 Tubazioni - Dalla 190lb-50215
 Circuito - A Partir Del 190lb-50215

5-BA16-043-A

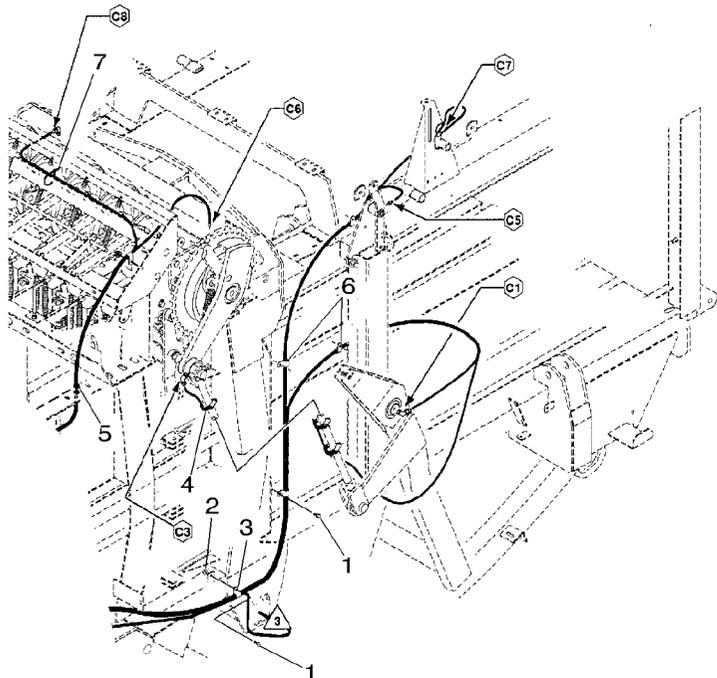
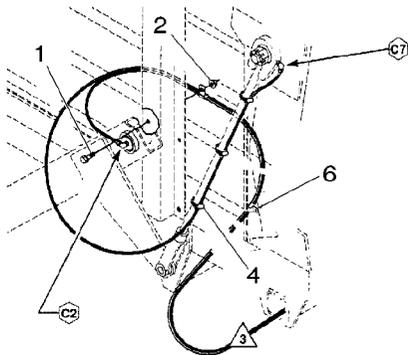

1	70921210	3/8"-16 X 1	7	CAPSCREW	VIS BOUCHON	HUTSCHRAUBE
2	Y704734	3/8"-16	7	LOCKNUT	TAPPO A VITE	TORNILLO TAPON
3	70926049	3/4"	7	LOCKNUT	ECROU BLOCAGE	SICHERUNGSMUTTER
4	70921911		2	CLAMP	AUTOBLOCCANTE	CONTRATUERCA
5	7827561		2	CLAMP	COLLIER	HALTESCHELLE
6	70925617	1/2"	6	CLAMP	FASCETTA	ABRAZADERA
7	70925094		6	CLAMP	COLLIER	HALTESCHELLE
			1	GROMMET	FASCETTA	ABRAZADERA
			5	CLAMP	PASSE FIL	GUMMITUELLE
			1	TIE	ANELLO PASSACAVO	PASACABLE
					COLLIER	HALTESCHELLE
					FASCETTA	ABRAZADERA
					ATTACHE	KUPPL.STANGE
					TRAVERSA ATTACCO	BARRA DE ENLACE

Lubrification
 Lubrification
 Schmierer
 Lubrificazione
 Engrase

50-195

Pump
 Pompe
 Pumpe
 Pompa
 Bomba

5-BA16-029-C

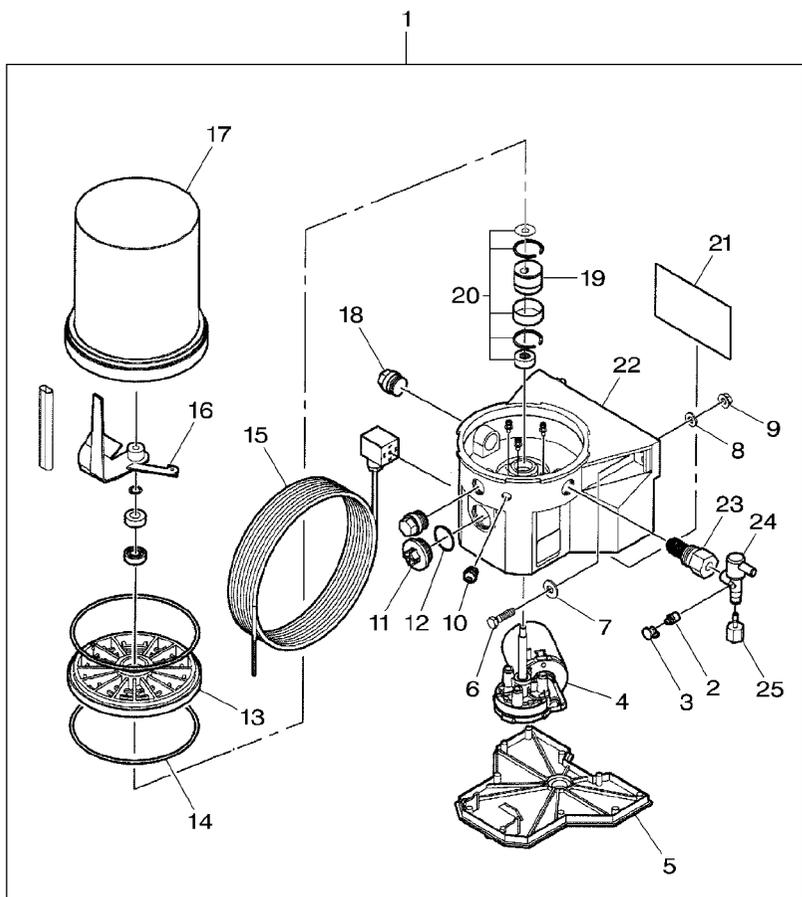

1	★700720087	➡ HN 91100	1 PUMP	POMPE	PUMPE
1	★700725825	➡ HN 91101	1 PUMP	POMPA	BOMBA
2	70914465	1 1/8"-27	1 GREASE NIPPLE	POMPE	PUMPE
3	700720101	1	1 CAP	POMPA	BOMBA
4	700724608	1	1 HYDRAULIC MOTOR	GRAISSEUR DROIT	FETT-NIPPEL
5	700724618	1	1 COVER	INGRASSAT.	ENGRASADOR
6	★700705617	1 5/16"-18 X 1-1/4	2 BOLT	CHAPEAU	KAPPE
7	70917642	1 5/16"	2 WASHER	CAPUCHON	TAPA
8	Y705525	1 5/16"	2 WASHER	MOTEUR HYDRAULIC	HYDROMOTOR
9	70931277	1 5/16"-18	2 NUT	MOTORE IDRAULICO	MOTOR HIDRAULICO
10	700724621	1	1 GREASER	COUVERCLE	DECKEL
11	700720105	1	1 PLUG	COPERCHIO	CUBIERTA
12	700720106	1	1 O RING	BOULON	MASCH.SCHRAUBE
13	700724603	1	1 PLATE	BULLONE	ESPIGA/BULON
14	700724602	1	2 O RING	RONDELLE	UNTERLEGSCHIEBE
15	★700720103	1 ➡ HN 91100	1 HARNESS	RONDELLA	ARANDELA
16	700724606	1	1 PADDLE	RONDELLA	UNTERLEGSCHIEBE
17	700724605	1	1 HYDRAULIC TANK	RONDELLA	ARANDELA
18	700720104	1	2 PLUG	ECROU	MUTTER
19	700724619	1	1 CAM	DADO	TUERCA
20	700724607	1	1 KIT, JOINT	GRAISSEUR	FETTNIPEL
21	★700724601	1 ➡ HN 91100	1 PRINTED CIRCUIT	INGRASSATORE	ENGRASADOR
21	★	➡ HN 91101	NOT USED	BOUCHON	VERSCHL.STOPFEN
22	700724620	1	1 BODY PUMP	TAPPO	TAPON
23	700720108	1	1 ELEMENT	JOINT TORIQUE	O-RING
				ANELLO TENUTA	ANILLO FORMA 'O'
				PLAQUE	PLATTE
				PIASTRA	PLATO
				JOINT TORIQUE	O-RING
				ANELLO TENUTA	ANILLO FORMA 'O'
				FAISCEAU	KABELBAUM
				FASCIOCAVI	MAZO CABLES
				NON UTILISE	NICHT VERWENDET
				INUSATO	NO SE USA
				PALE	PADDEL
				PALETTA	ESPATULA
				RESERVOIR HYDR	HYDRAULIKTANK
				SERBATOIO IDRAUL	DEPOSITO HIDRAU
				BOUCHON	VERSCHL.STOPFEN
				TAPPO	TAPON
				CAME	NOCKEN
				CAMMA	LEVA
				JEU JOINTS	DICHTUNGSSATZ
				KIT GIUNTO	JUEGO JUNTAS
				CIRCUIT IMPRIME	GEDRUCKTESCHALTG
				CIRCUITO STAMP.	CIRCUITO IMPRESO
				NON UTILISE	NICHT VERWENDET
				INUSATO	NO SE USA
				CORPS DE POMPE	PUMPENGEHAUSE
				CORPO POMPA	CUERPO DE BOMBA
				ELEMENT	ELEMENT
				ELEMENTO	ELEMENTO

Lubrication
 Lubrification
 Schmierer
 Lubrificazione
 Engrase

50-195

Pump
 Pompe
 Pumpe
 Pompa
 Bomba

5-BA16-029-C

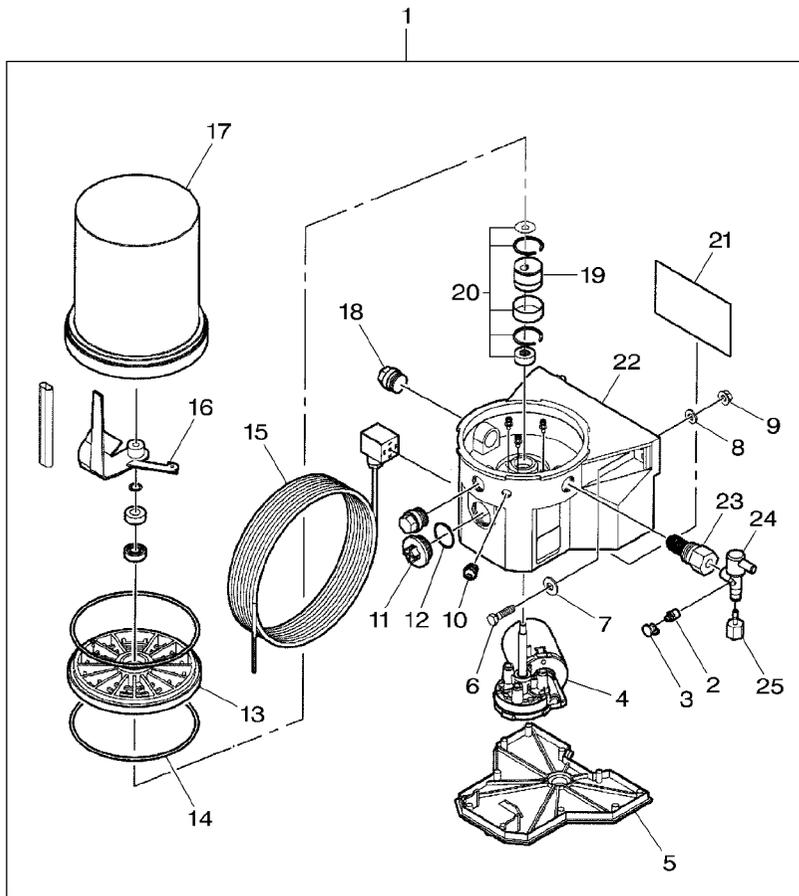

24	700720099	1	1 RELIEF VALVE	VALVE SECURITE	UEBERDR. VENTIL
				VAVOLA LIMITATR	VALV. DESCARG
25	700720100	1	1 ADAPTOR	ADAPTATEUR	REDUZIERNIPPEL
				ADATTATORE	ADAPTADOR
26	700724610	1 [B] 8 Amp	1 FUSE	FUSIBLE	SICHERUNG
				VALVOLINA	FUSIBLE
27	700724611	1 [B]	1 FUSE HOLDER	PORTE FUSIBLE	SICHERUNGSHALTER
				PORTA FUSIBILI	PORTAFUSIBLE
28	700724612	1 [B]	1 SWITCH	INTERRUPTEUR	SCHALTER
				INTERRUTTORE	INTERRUPTOR

[B] NOT ILLUSTRATED
 NON ILLUSTRATE
 NICHT ABGEBILDET
 NO ILLUSTRADO
 NO ILLUSTRATED

Lubrication
 Lubrification
 Schmierer
 Lubrificazione
 Engrase

50-200 → HP 91215

5-BA16-044-A

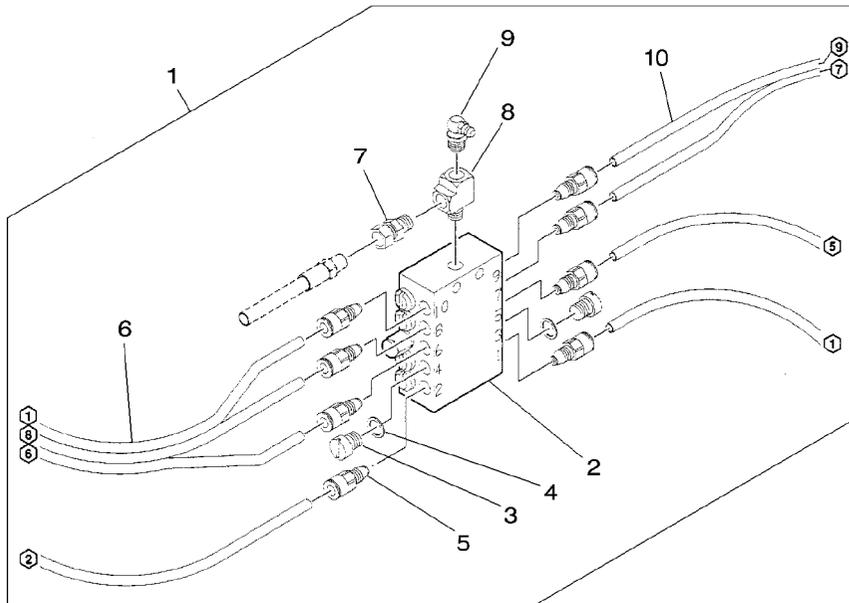

- | | | |
|----|-----------------|-----------------|
| 1 | 700718110 | |
| 2 | 700720097 | 1 |
| 3 | 700706841 | 1 |
| 4 | 700706839 | 1 |
| 5 | 700714008 | 1 |
| 6 | 700718113 | 1 ◀ |
| 7 | 700720091 | 1 |
| 8 | 700720092 | 1 |
| 9 | 70915276 | 1 1/8"-27 X 90° |
| 10 | 700718123 | 1 ▶ |

- | | | | |
|---|----------------|----------------------------|--------------------------------|
| 1 | HARNESS | FAISCEAU
FASCIOCAVI | KABELBAUM
MAZO CABLES |
| 1 | PRESSURE VALVE | VALVE
VALVOLA PRESSION | DRUCKVENTIL
VALVULA PRESION |
| 2 | PLUG | BOUCHON
TAPPO | VERSCHL.STOPFEN
TAPON |
| 2 | GASKET | JOINT
GUARNIZIONE | DICHTSCHEIBE
EMPAQUETADURA. |
| 8 | FITTING | MONTAGE
RACCORDO. | ANSCHL.VERSCHRBG
ACCESORIO. |
| 1 | HARNESS | FAISCEAU
FASCIOCAVI | KABELBAUM
MAZO CABLES |
| 1 | CONNECTOR | BORNE
MORSETTO | DOPPELNIPPEL
CONECTOR |
| 1 | TEEPIECE | TE
RACCORDO A T | T-STUECK
PIEZA EN T |
| 1 | NIPPLE | GRAISSEUR COUDE
NIPPLIO | NIPPEL
NIPLE |
| 1 | HOSE | DURITE
TUBO FLESSIBILE | SCHLAUCH
FLEXIBLE |

TUBE PORT LENGTH	DESCRIPTION
① 2775	STUFFER BEARING, LEFT
② 1625	STUFFER BEARING, RIGHT
③ N/C	PLUG-CLOSURE
④ N/C	PLUG-CLOSURE
⑤ 900	PICKUP FLOATATION
⑥ 2800	STUFFER ARM, LEFT
⑦ 3600	STUFFER ARM, RIGHT
⑧ 3900	NEEDLE SAFETY
⑨ 2600	HOLDING FINGER PIVOT
⑩ 2400	STUFFER CLUTCH PIVOT

Lubrication
 Lubrification
 Schmierer
 Lubrificazione
 Engrase

50-205

➔ HP 91215

5-BA16-045-A

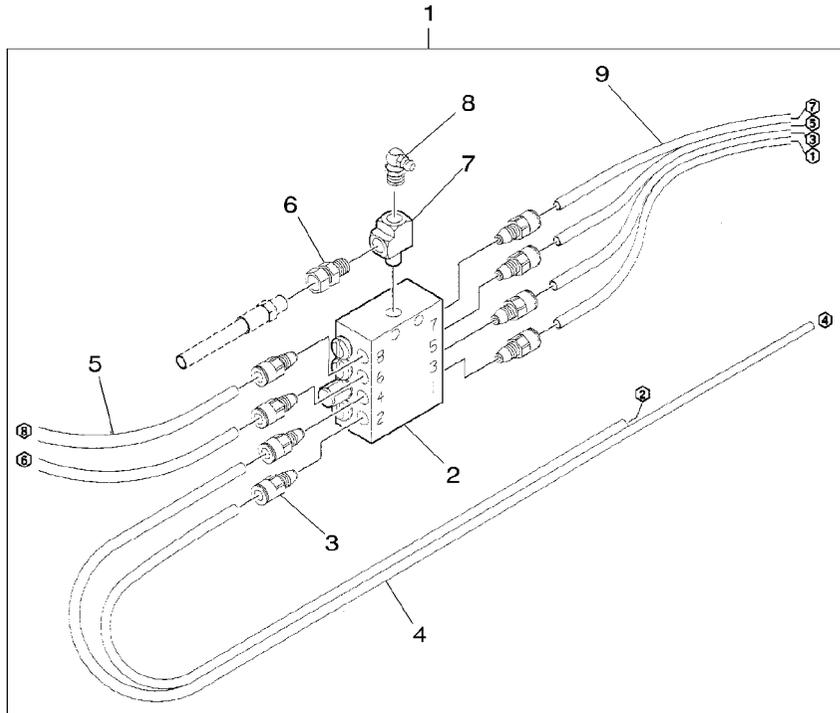

TUBE PORT LENGTH mm	DESCRIPTION
① 2700	PIVOT-NEEDLE,LEFT
② 4925	PIVOT-NEEDLE,RIGHT
③ 4400	CONN. ROD-NEEDLE,LEFT
④ 8525	CONN. ROD-NEEDLE,RIGHT
⑤ 2925	PIVOT-BELLCRANK,SALE LENGTH
⑥ 3000	KNOTTER-LEFT
⑦ 3075	PIVOT-STARWHEEL
⑧ 3550	KNOTTER-CENTER

1	700718111	
2	700706837	1
3	700714008	1
4	700718124	1 ▶
5	700718125	1
6	700720091	1
7	700720092	1
8	70915276	1 1/8"-27 X 90°
9	700113690	1 ◀

HARNESS	FAISCEAU FASCIOCAVI SOUPAPE VALVOLA MONTAGE RACCORDO.	KABELBAUM MAZO CABLES VENTIL VALVULA ANSCHL.VERSCHRBG ACCESORIO.
1 VALVE.		
8 FITTING		
1 HOSE	DURITE TUBO FLESSIBILE	SCHLAUCH FLEXIBLE
1 HOSE	DURITE TUBO FLESSIBILE	SCHLAUCH FLEXIBLE
1 CONNECTOR	BORNE MORSETTO	DOPPELNIPPEL CONECTOR
1 TEEPIECE	TE RACCORDO A T	T-STUECK PIEZA EN T
1 NIPPLE	GRAISSEUR COUDE NIPPO	NIPPEL NIPPEL
1 HARNESS	FAISCEAU FASCIOCAVI	KABELBAUM MAZO CABLES

Lubrification
 Lubrification
 Schmierer
 Lubrificazione
 Engrase

50-210 → HP 91215

5-BA16-046-B

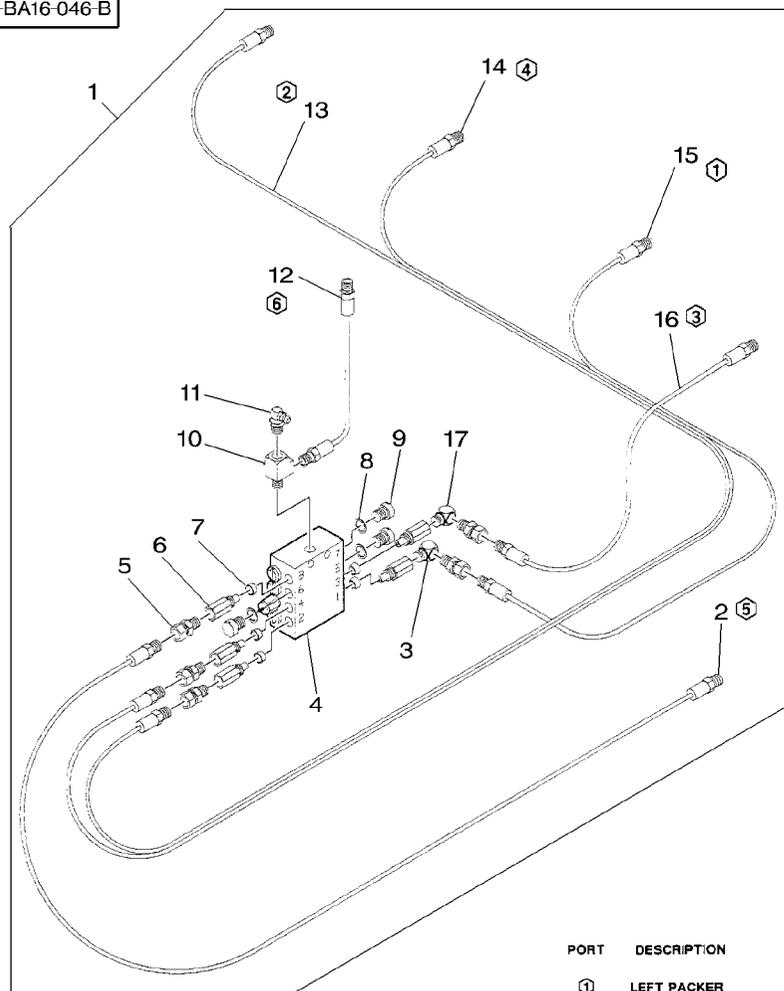

PORT	DESCRIPTION
①	LEFT PACKER
②	RIGHT PACKER
③	FRONT VALVE
④	CENTER PACKER
⑤	REAR VALVE
⑥	LUBE PUMP

1	700718112		1	HARNES	FAISCEAU	KABELBAUM
2	700718129	1 ◀▶ 1800 MM	1	HOSE	FASCIOCAVI	MAZO CABLES
3	700720096	1	1	ELBOW	DURITE	SCHLAUCH
4	700706837	1	1	VALVE.	TUBO FLESSIBILE	FLEXIBLE
5	700720091	1	1	CONNECTOR	COUDE	WINKELSTUECK
6	700720095	1	5	VALVE CHECK	GOMITO	CODO
7	700706678	1	1	FERRULE	SOUPAPE	VENTIL
8	700706839	1	5	VALVE CHECK	VALVOLA	VALVULA
9	700706841	1	5	FERRULE	BORNE	DOPPELNIPPEL
10	700720092	1	5	VALVE CHECK	MORSETTO	CONECTOR
11	70915276	1 1/8" -27 X 90°	5	VALVE CHECK	VALVE CONTROLE	PRUEFVENTIL
12	700718126	1 ◀▶ 530 MM	5	FERRULE	VALVOLA RITEGNO	VALVULA D CIERRE
13	700720082	1 ◀▶ 1470 MM	5	FERRULE	VIROLE	ZWINGE
14	700720083	1 ◀▶ 1100 MM	3	GASKET	PUNTALE	MANGTO METALICO
15	700718128	1 ◀▶ 800 MM	3	GASKET	JOINT	DICHTSCHEIBE
16	700718127	1 ◀▶ 700 MM	3	PLUG	GUARNIZIONE	EMPAQUETADURA.
17	700718963	1	3	PLUG	BOUCHON	VERSCHL.STOPFEN
			1	TEEPIECE	TAPPO	TAPON
			1	NIPPLE	TE	T-STUECK
			1	HOSE	RACCORDO A T	PIEZA EN T
			1	HOSE	GRAISSEUR COUDE	NIPPEL
			1	HOSE	NIPPLO	NIPLE
			1	HOSE	DURITE	SCHLAUCH
			1	HOSE	TUBO FLESSIBILE	FLEXIBLE
			1	HOSE	DURITE	SCHLAUCH
			1	HOSE	TUBO FLESSIBILE	FLEXIBLE
			1	HOSE	DURITE	SCHLAUCH
			1	HOSE	TUBO FLESSIBILE	FLEXIBLE
			1	HOSE	DURITE	SCHLAUCH
			1	HOSE	TUBO FLESSIBILE	FLEXIBLE
			1	ELBOW	DURITE	SCHLAUCH
			1	ELBOW	TUBO FLESSIBILE	FLEXIBLE
			1	ELBOW	COUDE	WINKELSTUECK
			1	ELBOW	GOMITO	CODO

Lubrication
 Lubrification
 Schmierer
 Lubrificazione
 Engrase

50-215

➔ HP 91216

5-BA16-051-B

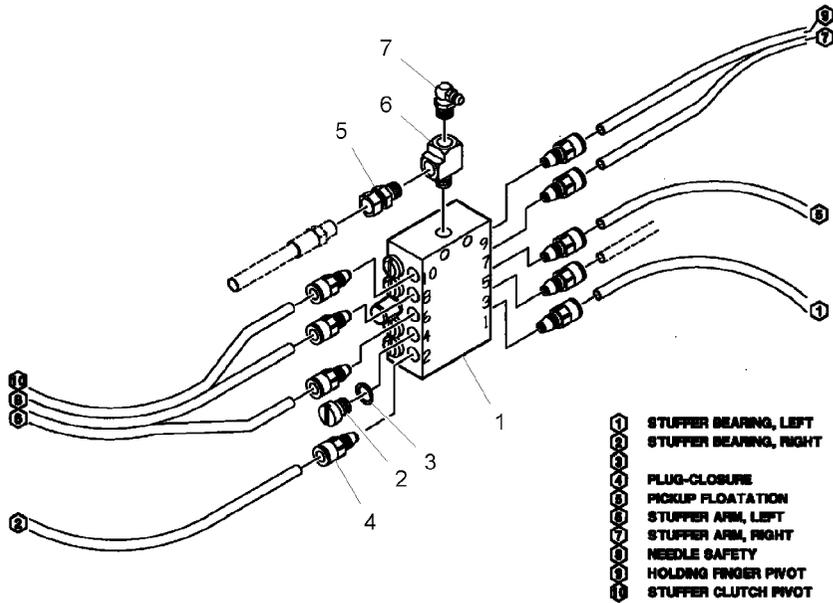

- 1 ★700720097
- 2 ★700706841
- 3 ★700706839
- 4 ★700714008
- 5 ★700720091
- 6 ★700720092
- 7 ★70915276

1/8"-27 X 90°

1 PRESSURE VALVE	VALVE VALVOLA PRESSION	DRUCKVENTIL VALVULA PRESION
1 PLUG	BOUCHON TAPPO	VERSCHL.STOPFEN TAPON
1 GASKET	JOINT GUARNIZIONE	DICHTSCHEIBE EMPAQUETADURA.
9 FITTING	MONTAGE RACCORDO.	ANSCHL.VERSCHRBG ACCESORIO.
1 CONNECTOR	BORNE MORSETTO	DOPPELNIPPEL CONECTOR
1 TEEPIECE	TE RACCORDO A T	T-STUECK PIEZA EN T
1 NIPPLE	GRAISSEUR COUDE NIPPLO	NIPPEL NIPLE

- ① STUFFER BEARING, LEFT
- ② STUFFER BEARING, RIGHT
- ③ PLUG-CLOSURE
- ④ PICKUP FLOATATION
- ⑤ STUFFER ARM, LEFT
- ⑥ STUFFER ARM, RIGHT
- ⑦ NEEDLE SAFETY
- ⑧ HOLDING FINGER PIVOT
- ⑨ STUFFER CLUTCH PIVOT

Lubrification
 Lubrification
 Schmierer
 Lubrificazione
 Engrase

50-220

➔ HP 91216

5-BA16-068-B

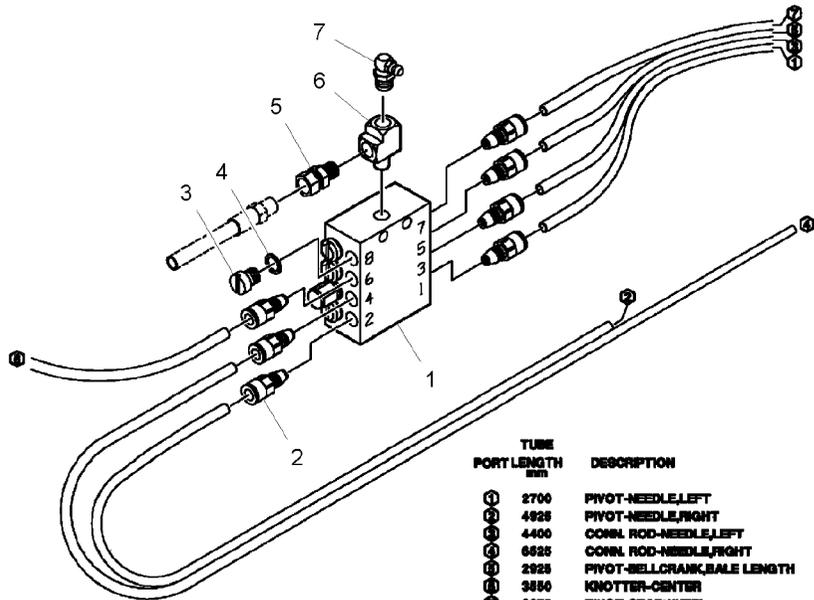

TUBE PORT LENGTH mm	DESCRIPTION
① 2700	PIVOT-NEEDLE,LEFT
② 4925	PIVOT-NEEDLE,RIGHT
③ 4400	CONN. ROD-NEEDLE,LEFT
④ 6625	CONN. ROD-NEEDLE,RIGHT
⑤ 2925	PIVOT-BELL-CRANK,BALE LENGTH
⑥ 3850	KNOTTER-CENTER
⑦ 3975	PIVOT-STARWHEEL
⑧ N/C	PLUG

- 1 ★ 700706837
- 2 ★ 700714008
- 3 ★ 700706841
- 4 ★ 700706839
- 5 ★ 700720091
- 6 ★ 700720092
- 7 ★ 70915276

1/8"-27 X 90°

1 VALVE.	SOUPE	VENTIL
7 FITTING	VALVOLA	VALVULA
1 PLUG	MONTAGE	ANSCHL.VERSCHRBG
1 GASKET	RACCORDO.	ACCESORIO.
1 CONNECTOR	BOUCHON	VERSCHL.STOPFEN
1 TEEPIECE	TAPPO	TAPON
1 NIPPLE	JOINT	DICHTSCHEIBE
	GUARNIZIONE	EMPAQUETADURA.
	BORNE	DOPPELNIPPEL
	MORSETTO	CONECTOR
	TE	T-STUECK
	RACCORDO A T	PIEZA EN T
	GRAISSEUR COUDE	NIPPEL
	NIPPO	NIPLE

Lubrication
 Lubrification
 Schmierer
 Lubrificazione
 Engrase

50-225

➔ HP 91216

5-BA16-069-B

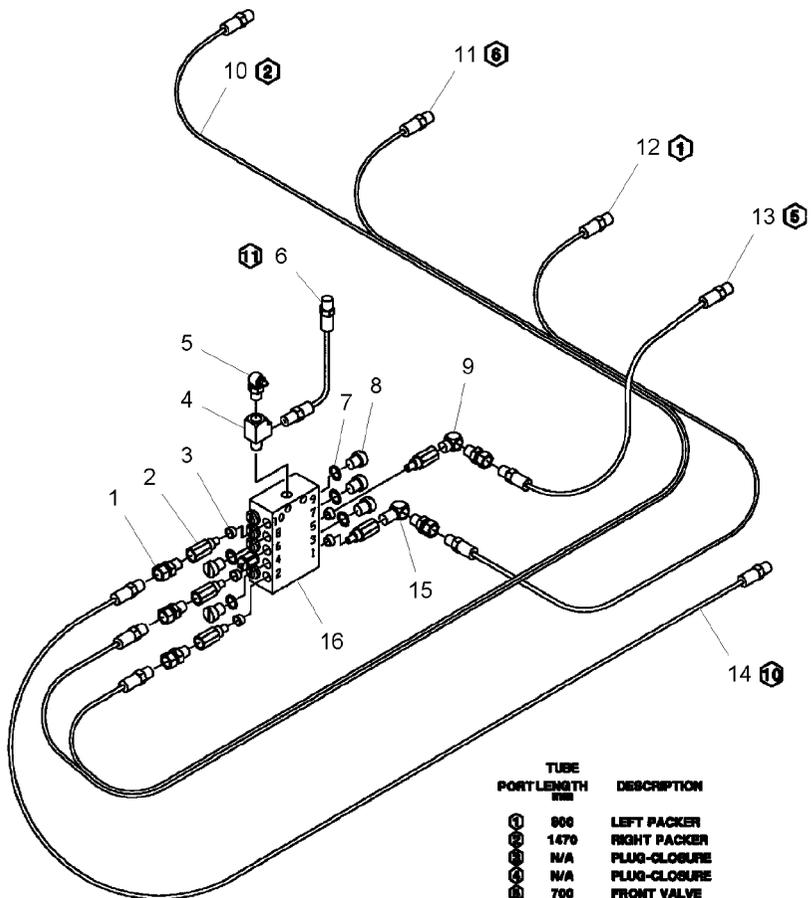

TUBE PORT LENGTH mm	DESCRIPTION
① 900	LEFT PACKER
② 1470	RIGHT PACKER
③ N/A	PLUG-CLOSURE
④ N/A	PLUG-CLOSURE
⑤ 700	FRONT VALVE
⑥ 1100	CENTER PACKER
⑦ N/A	PLUG-CLOSURE
⑧ N/A	PLUG-CLOSURE
⑨ N/A	PLUG-CLOSURE
⑩ 1800	REAR VALVE
⑪ 530	LUBE PUMP

- 1★700720091
- 2★700720095
- 3★700706678
- 4★700720092
- 5★70915276
- 6★700718126
- 7★700706839
- 8★700706841
- 9★700718963
- 10★700720082
- 11★700720083
- 12★700718128
- 13★700718127
- 14★700718129
- 15★700718962
- 16★700720097

5 CONNECTOR	BORNE MORSETTO	DOPPELNIPPEL CONECTOR
5 VALVE CHECK	VALVE CONTROL VALVOLA RITEGNO	PRUEFVENTIL VALVULA D CIERRE
5 FERRULE	VIROLE PUNTALE	ZWINGE MANGTO METALICO
1 TEEPIECE	TE RACCORDO A T	T-STUECK PIEZA EN T
1 NIPPLE	GRAISSEUR COUDE NIPPLO	NIPPEL NIPLE
1 HOSE	DURITE TUBO FLESSIBILE	SCHLAUCH FLEXIBLE
5 GASKET	JOINT GUARNIZIONE	DICHTSCHEIBE EMPAQUETADURA
5 PLUG	BOUCHON TAPPO	VERSCHL.STOPFEN TAPON
1 ELBOW	COUDE GOMITO	WINKELSTUECK CODO
1 HOSE	DURITE TUBO FLESSIBILE	SCHLAUCH FLEXIBLE
1 HOSE	DURITE TUBO FLESSIBILE	SCHLAUCH FLEXIBLE
1 HOSE	DURITE TUBO FLESSIBILE	SCHLAUCH FLEXIBLE
1 HOSE	DURITE TUBO FLESSIBILE	SCHLAUCH FLEXIBLE
1 HOSE	DURITE TUBO FLESSIBILE	SCHLAUCH FLEXIBLE
1 HOSE	DURITE TUBO FLESSIBILE	SCHLAUCH FLEXIBLE
1 ELBOW	COUDE GOMITO	WINKELSTUECK CODO
1 PRESSURE VALVE	VALVE VALVOLA PRESSION	DRUCKVENTIL VALVULA PRESSION

Lubrication
 Lubrification
 Schmierer
 Lubrificazione
 Engrase

50-230

Kit
 Kit
 Kit
 Kit
 Kit

5-BA16-021-C

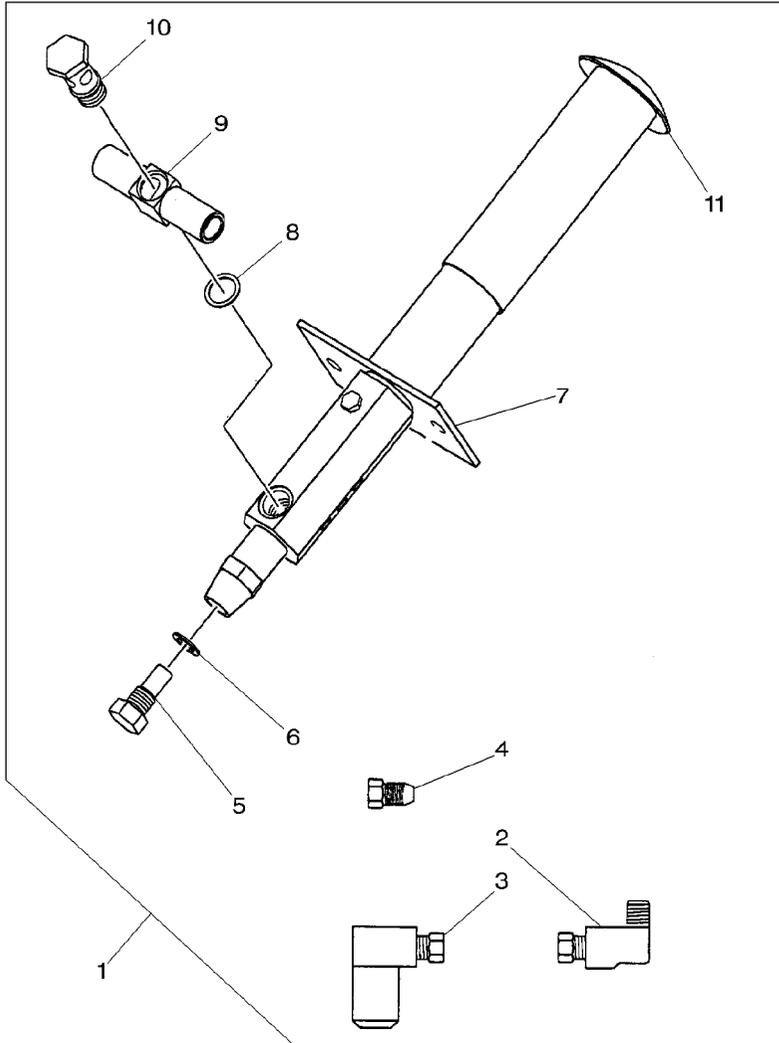

1	700710807	
2	792259	1
3	700706279	1
4	700706277	1
5	700706539	1
6	700706540	1
7	700113361P	1
8	700706541	1
9	700706542	1
10	700706543	1
11	700706276	1

1	KIT	JEU KIT	SATZ JUEGO
46	ELBOW	COUDE GOMITO	WINKELSTUECK CODO
2	COUPLER	ACCOUPLMENT ACCOPIATORE	KUPPLUNGSSTUECK ACOPLADOR
48	NUT	ECROU DADO	MUTTER TUERCA
4	PLUG	BOUCHON TAPPO	VERSCHL.STOPFEN TAPON
4	GASKET	JOINT GUARNIZIONE	DICHTSCHEIBE EMPAQUETADURA.
4	PLATE	PLAQUE PIASTRA	PLATTE PLATO
4	GASKET	JOINT GUARNIZIONE	DICHTSCHEIBE EMPAQUETADURA.
4	NIPPLE	GRAISSEUR COUDE NIPPLO	NIPPEL NIPLE
4	STUD	GOUJON PRIGIONIERO	STEBBOLZEN CHAVETA ROSCADO
4	PUMP	POMPE POMPA	PUMPE BOMBA

Lubrication
 Lubrification
 Schmierer
 Lubrificazione
 Engrase

50-235

Kit
 Kit
 Kit
 Kit
 Kit

5-BA16-022-C

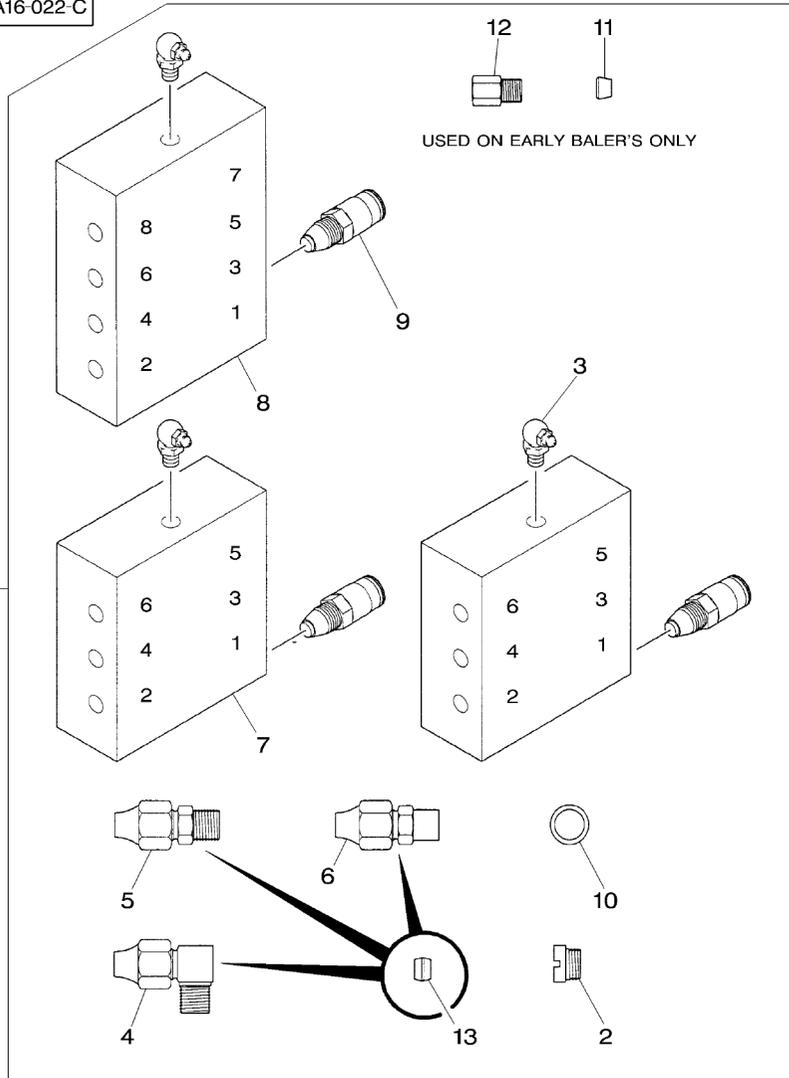

- 1 **700710805**
- 2 700706841
- 3 **70915276** 1 1/8"-27 X 90°
- 4 **700706682**
- 5 **700706683**
- 6 700706840
- 7 700706835
- 8 700706837
- 9 700714008
- 10 700706839
- 11 700706678
- 12 700706684
- 13 700706679

- | | | |
|-------------|-----------------|------------------|
| 1 KIT | JEU | SATZ |
| 1 PLUG | KIT | JUEGO |
| 3 NIPPLE | BOUCHON | VERSCHL.STOPFEN |
| 10 ELBOW | TAPPO | TAPON |
| 6 CONNECTOR | GRAISSEUR COUDE | NIPPEL |
| 3 CONNECTOR | NIPPLO | NIPLE |
| 2 VALVE. | COUDE | WINKELSTUECK |
| 1 VALVE. | GOMITO | CODO |
| 19 FITTING | BORNE | DOPPELNIPPEL |
| 1 GASKET | MORSETTO | CONECTOR |
| 19 FERRULE | BORNE | DOPPELNIPPEL |
| 19 NUT | MORSETTO | CONECTOR |
| 19 SLEEVE | SOUPAPE | VENTIL |
| | VALVOLA | VALVULA |
| | SOUPAPE | VENTIL |
| | VALVOLA | VALVULA |
| | MONTAGE | ANSCHL.VERSCHRBG |
| | RACCORDO. | ACCESORIO. |
| | JOINT | DICHTSCHEIBE |
| | GUARNIZIONE | EMPAQUETADURA. |
| | VIROLE | ZWINGE |
| | PUNTALE | MANGTO METALICO |
| | ECROU | MUTTER |
| | DADO | TUERCA |
| | MANCHON | HUELSE |
| | MANICOTTO | MANCHA |

Lubrication
 Lubrification
 Schmierer
 Lubrificazione
 Engrase

50-240

Kit
 Kit
 Kit
 Kit
 Kit

5-BA16-009-C

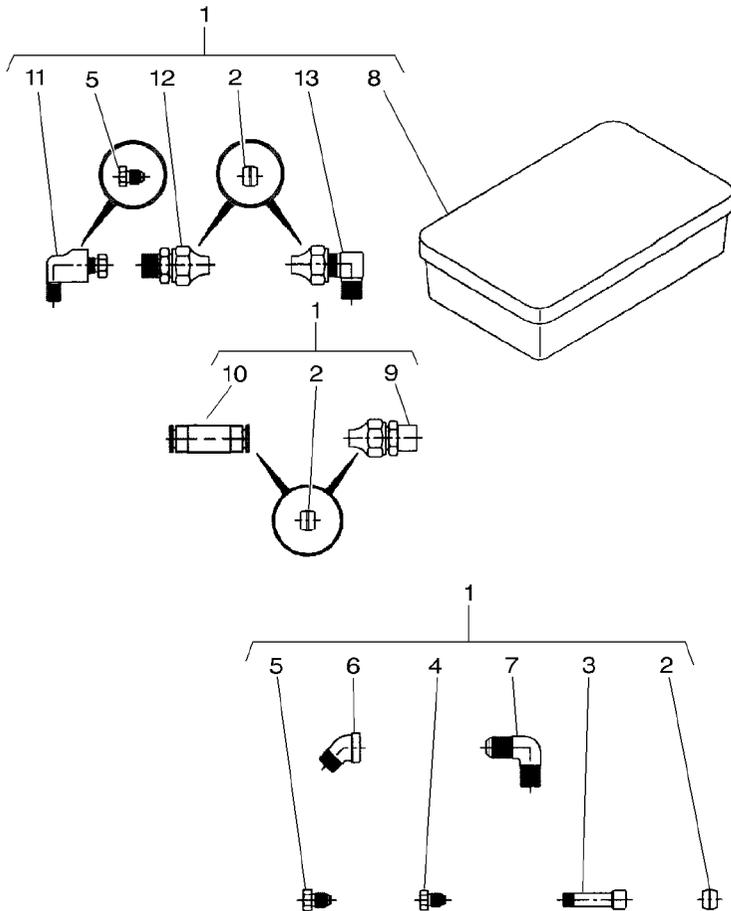

1	700114079		1	BOX	BOITE SCATOLA	DOSE CAJA
2	700706679	1	4	SLEEVE	MANCHON MANICOTTO	HUELSE MANCHA
3	700706280	1	1	EXTENSION	RALLONGE PROLUNGA	VERLAENGERUNG ENSANCHE
4	700706277	1	4	NUT	ECROU DADO	MUTTER TUERCA
5	700706898	1	6	NUT	ECROU DADO	MUTTER TUERCA
6	Y746461	1	1	ELBOW	COUDE GOMITO	WINKELSTUECK CODO
7	70919173	1	1	ELBOW	COUDE GOMITO	WINKELSTUECK CODO
8	700707474	1	1	BOX	BOITE SCATOLA	DOSE CAJA
9	700706840	1	1	CONNECTOR	BORNE MORSETTO	DOPPELNIPPEL CONECTOR
10	700706843	1	2	UNION	RACCORD RACCORDO	VERSCHRAUBUNG RACOR
11	792259	1	2	ELBOW	COUDE GOMITO	WINKELSTUECK CODO
12	700706683	1	2	CONNECTOR	BORNE MORSETTO	DOPPELNIPPEL CONECTOR
13	700706682	1	2	ELBOW	COUDE GOMITO	WINKELSTUECK CODO

Lubrication
 Lubrification
 Schmierer
 Lubrificazione
 Engrase

50-245

Service
 Service
 Wartungs
 Servizio
 Servizio

5-BA16-033-C

1	700720098		1	KIT	JEU KIT	SATZ JUEGO
2	700706682	1	11	ELBOW	COUDE GOMITO	WINKELSTUECK CODO
3	700706679	2	1	SLEEVE	MANCHON MANICOTTO	HUELSE MANCHA
4	700706683	1	6	CONNECTOR	BORNE MORSETTO	DOPPELNIPPEL CONECTOR
5	700706679	4	1	SLEEVE	MANCHON MANICOTTO	HUELSE MANCHA

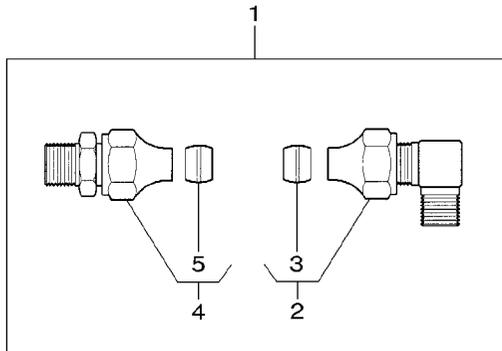

--	--	--

60

Bale Tensioner
Chambre De Compression
Kanalverstellung
Tenditore Balle
Tensor Paca

60-5

5-BA41-003-B

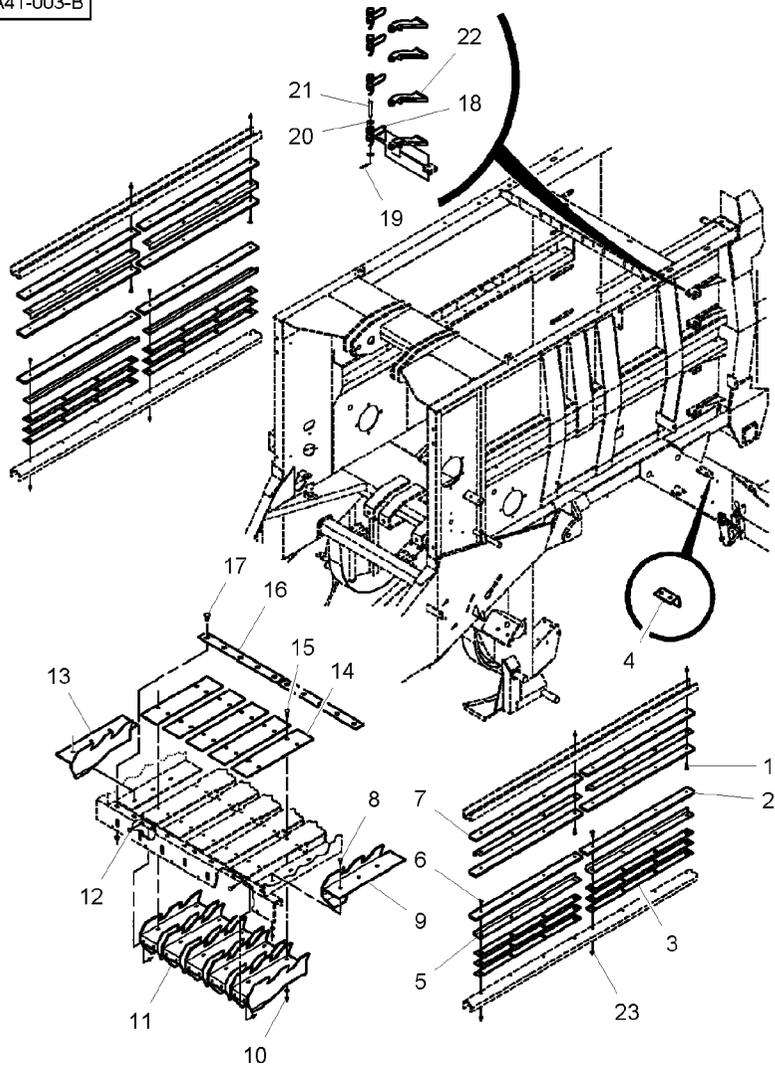

1	★8701377	3/8"-16 X 1-3/4	16	CAPSCREW	VIS BOUCHON	HUTSCHRAUBE
2	★700113607		8	RAIL	TAPPO A VITE	TORNILLO TAPON
3	★700113604P	⚡ 0.46/.018	12	SHIM	RAIL	SCHIENE
4	★700163367M				SBARRA	RIEL
5	★700113608P		2	SUPPORT	CALE REGLAGE	EINSTELLBLECH
6	★70934842	3/8"-16 X 1-1/4	8	ANGLE.	SPESSORE	CALCE
7	★700113606P		2	SUPPORT	SUPPORTO	LAGERUNG
8	★Y707042	3/8"-16 X 1			SUPPORTO	DISPOS.DE SOSTEN
9	★700113600P	◀	8	ANGLE.	EQUERRE	WINKEL
10	★Y705533	3/8"			ANGOLO	ANGULO
10	★70916950	3/8"-16	16	CAPSCREW	VIS BOUCHON	HUTSCHRAUBE
11	★700113594P		4	RAIL	TAPPO A VITE	TORNILLO TAPON
12	★70923220	3/8"-16 X 1-1/4			RAIL	SCHIENE
12	★70916950	3/8"-16	6	BOLT	SBARRA	RIEL
13	★700113601P	▶	1	DOG	BOULON	MASCH.SCHRAUBE
14	★700113616P		26	WASHER	BULLONE	ESPIGA/BULON
15	★Y707240	3/8"-16 X 1-1/2			CHIEN	KLAUE
16	★700706377		1	DOG	CANE	PRISIONERO
17	★707448	1/2"-13 X 1-1/2	26	NUT	RONDELLE	UNTERLEGSCHIEBE
17	★704254	1/2"-13			RONDELLA	ARANDELA
18	★700706376B		26	NUT	ECROU	MUTTER
19	★98-2107		5	DOG	DADO	TUERCA
20	★Y705582	5/8"	10	BOLT	CHIEN	KLAUE
21	★700706685	5/8" X 3-3/4	10	BOLT	CANE	PRISIONERO
22	★700137654P		1	DOG	PLAQUE	PLATTE
23	★70916950	3/8"-16	5	PLATE	PIASTRA	PLATO
			20	BOLT	BOULON	MASCH.SCHRAUBE
			2	KNIFE	BULLONE	ESPIGA/BULON
			10	BOLT	COLTELLI	MESSER
			10	LOCKNUT	BOULON	CUCHILLA
			8	SPRING	BULLONE	MASCH.SCHRAUBE
			8	PIN	ECROU BLOCCAGE	ESPIGA/BULON
			16	WASHER	AUTOBLOCCANTE	SICHERUNGSMUTTER
			8	CLEVIS PIN	RESSORT	CONTRATUERCA
			8	DOG	MOLLA	FEDER
			16	WASHER	GOUPILLE	RESORTE
			8	CLEVIS PIN	PERNO	BOLZEN
			8	DOG	RONDELLE	PASADOR
			32	NUT	RONDELLA	UNTERLEGSCHIEBE
					AXE	ARANDELA
					PERNO D'ATTACCO	SPLINTBOLZEN
					CHIEN	BULON CILINDRICO
					CANE	KLAUE
					ECROU	PRISIONERO
					DADO	MUTTER
						TUERCA

Bale Tensioner
Chambre De Compression
Kanalverstellung
Tenditore Balle
Tensor Paca

60-10

5-BA41-004-B

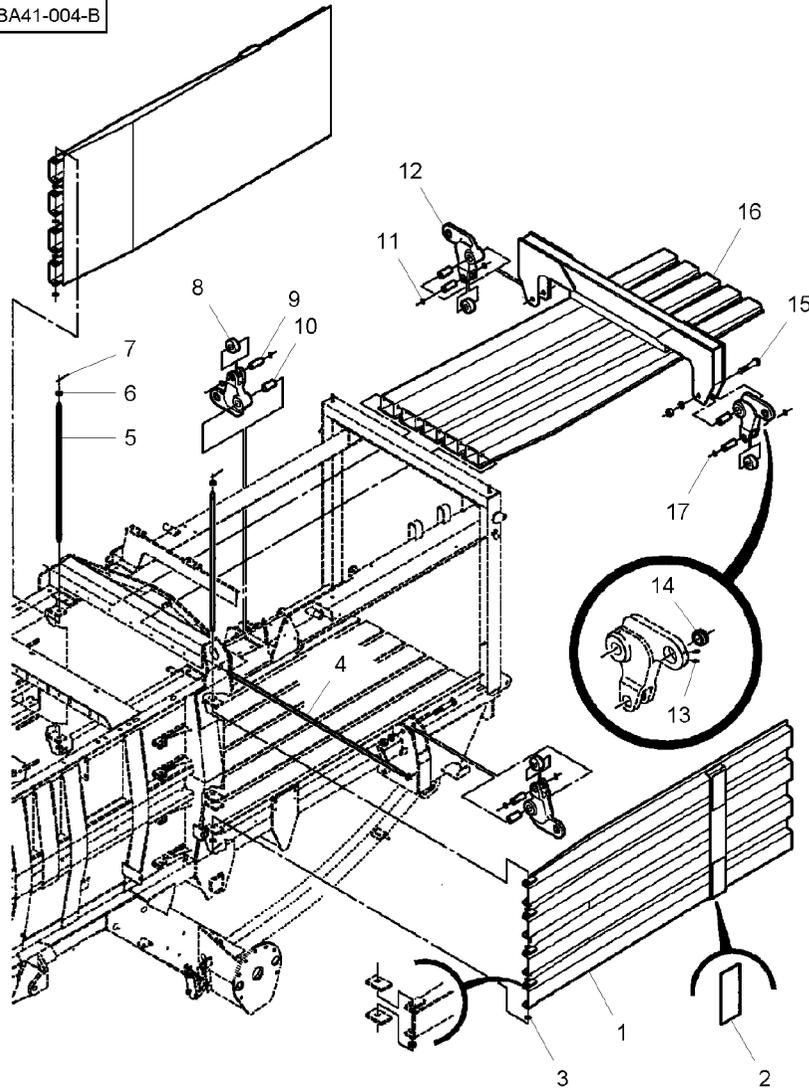

1	★700113586P		2	DOOR	PORTIERE	TUER
2	★6529317	1	2	PLATE	PORTA	PUERTA
3	★52761	3/4" X 14			PLAQUE	PLATTE
4	★6529432				PIASTRA	PLATO
5	★700113609P		8	BUSH	BAGUE	BUCHSE
6	★Y705566	3/4"			BOCCOLA	CASQUILLO
7	★354089X1	1/4" X 1-1/4	1	PIN	GOUPILLE	BOLZEN
8	★700113614		2	PIN	PERNO	PASADOR
9	★700113615				GOUPILLE	BOLZEN
10	★6529408		6	WASHER	PERNO	PASADOR
11	★852137				RONDELLE	UNTERLEGSCHIEBE
12	★700113610P				RONDELLA	ARANDELA
13	★70923219	12 1/4"-28	6	PIN	GOUPILLE	BOLZEN
14	★70936273	12			PERNO	PASADOR
15	★700710312	1"-8 X 5-1/2	4	ROLLER	GALET	ROLLE
16	★70931390	1"-8			RULLO	RODILLO
17	★700113577P		4	PIN	GOUPILLE	BOLZEN
					PERNO	PASADOR
			4	BUSH	BAGUE	BUCHSE
					BOCCOLA	CASQUILLO
			4	RING	ANNEAU	RING
					ANELLO	ARO
			4	ARM	BRAS	ARM
					BRACCIO	BRAZO
			2	GREASER	GRAISSEUR	FETTNIPPEL
					INGRASSATORE	ENGRASADOR
			1	BUSH	BAGUE	BUCHSE
					BOCCOLA	CASQUILLO
			4	CAPSCREW	VIS BOUCHON	HUTSCHRAUBE
					TAPPO A VITE	TORNILLO TAPON
			4	NUT	ECROU	MUTTER
					DADO	TUERCA
			1	DOOR	PORTIERE	TUER
					PORTA	PUERTA
			4	GREASER	GRAISSEUR	FETTNIPPEL
					INGRASSATORE	ENGRASADOR

Shields
Garants
Schutzbleche
Difese
Proteccionee

60-15

Front - Up To 190lb-50100
Avant - Jusqu Au 190lb-50100
Vorne - Bis 190lb-50100
Anteriore - Fino Alla 190lb-50100
Delantero - Hasta 190lb-50100

5-BA17-015-A

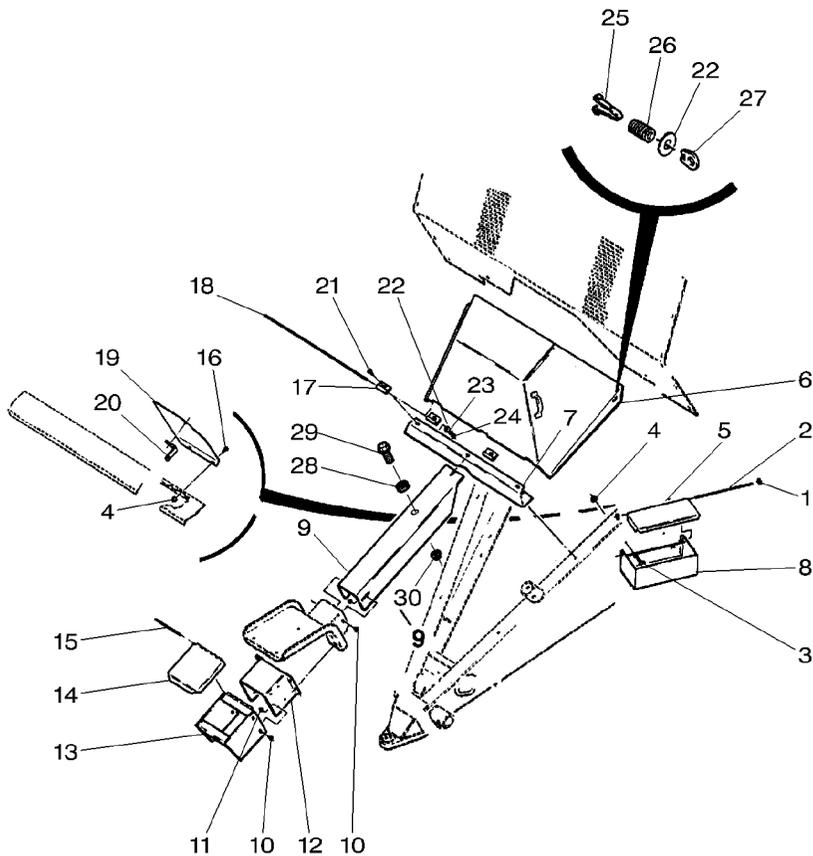

1	700707858		2	RETAINER	RETENEUR	HALTERING
2	700108570			FERMO	RETENEDOR	
3	7703432	3/8"-16 X 3/4	1	ROD	TRINGLE	STANGE
4	704247	3/8"-16		ASTA	VARILLA	
5	700108569P		2	CAPSCREW	VIS BOUCHON	HUTSCHRAUBE
6	700113986			TAPPO A VITE	TORNILLO TAPON	
7	700133740P		5	NUT	ECROU	MUTTER
8	700108566P			DADO	TUERCA	
9	700114006P		1	LID	PLAQUE COUVERCLE	ABDECKPLATTE
10	7883317	5/16"-18 X 1/2		COPERTA	COBERTURA	
11	70931277	5/16"-18	1	SHIELD	TOLE	SCHILD
12	700114012P			RIPARO	BLINDAJE	
13	700114007P		1	CHANNEL	CANAL	KANAL
14	700114013P			PROFILATO	CANAL	
15	700116914		1	BOX	BOITE	DOSE
16	7883382	3/8"-16 X 1		SCATOLA	CAJA	
17	700113994		1	SHIELD	TOLE	SCHILD
18	65052			RIPARO	BLINDAJE	
19	700114023P		6	SCREW	VIS	SCHRAUBE
20	700114024			VITE	TORNILLO	
21	7883325	5/16"-18 X 3/4	6	NUT	ECROU	MUTTER
22	Y705525	5/16"		DADO	TUERCA	
23	353446X1	5/16"	1	SHIELD	TOLE	SCHILD
24	355565X1	5/16"-18		RIPARO	BLINDAJE	
25	7894975		1	COVER	COUVERCLE	DECKEL
26	7758212			COPERCHIO	CUBIERTA	
			1	PIN	GOUPILLE	BOLZEN
				PERNO	PASADOR	
			3	SCREW	VIS	SCHRAUBE
				VITE	TORNILLO	
			3	SUPPORT	SUPPORT	LAGERUNG
				SUPPORTO	DISPOS.DE SOSTEN	
			1	PIN	GOUPILLE	BOLZEN
				PERNO	PASADOR	
			1	SHIELD	TOLE	SCHILD
				RIPARO	BLINDAJE	
			1	ANGLE.	EQUERRE	WINKEL
				ANGOLO	ANGULO	
			5	SCREW	VIS	SCHRAUBE
				VITE	TORNILLO	
			6	WASHER	RONDELLE	UNTERLEGSCHIEBE
				RONDELLA	ARANDELA	
			5	LOCK WASHER	RONDELLE FREIN	FEDERRING
				ROSETTA DENTELL.	ARANDELA GROWER	
			5	NUT UNC	ECROU UNC	MUTTER UNC
				DADO UNC	TUERCA UNC	
			1	CLIP	CLIP	SHELLE
				FERMAGLIO	CLIP	
			1	SPRING	RESSORT	FEDER
				MOLLA	RESORTE	

Shields
Garants
Schutzbleche
Difese
Proteccionee

60-15

Front - Up To 190lb-50100
Avant - Jusqu Au 190lb-50100
Vorne - Bis 190lb-50100
Anteriore - Fino Alla 190lb-50100
Delantero - Hasta 190lb-50100

5-BA17-015-A

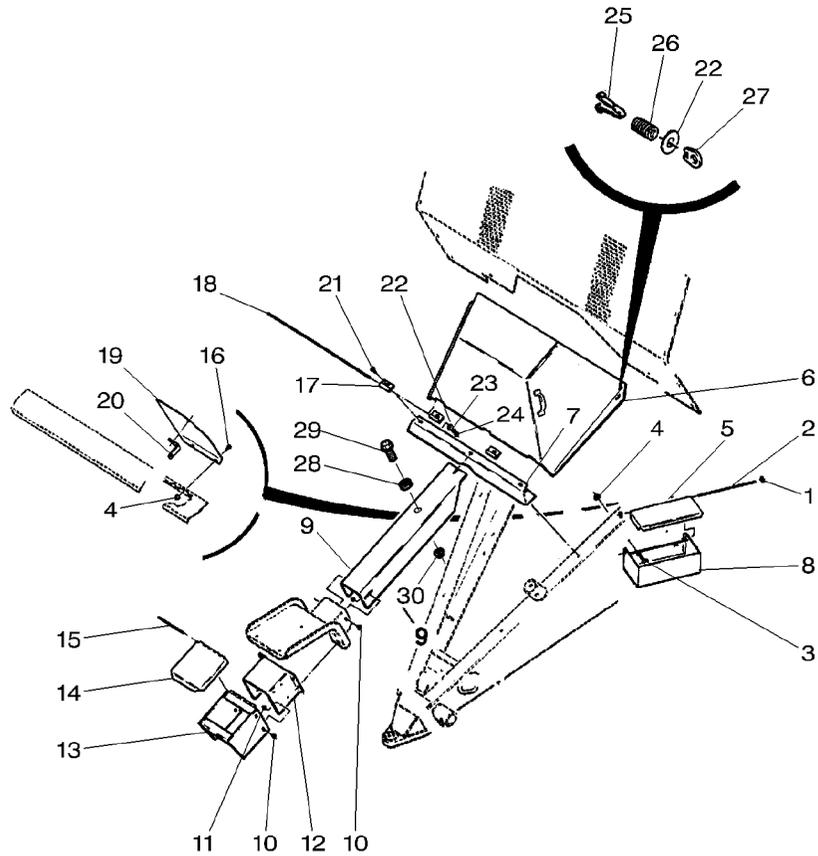

27	7894967		1 HANDLE	POIGNEE MANIGLIA MANETA	HANDGRIFF MANETA
28	700708648		1 BUMPER	PARE CHOC PARAURTI PARAGOLPES	STOSSFAENGER PARAGOLPES
29	700707203	No 12-24 X 3/4	1 SCREW	VIS VITE	SCHRAUBE TORNILLO
30	71345596	No 12-24	1 NUT	ECROU DADO	MUTTER TUERCA

Shields
Garants
Schutzbleche
Difese
Proteccionee

60-20

Front - From 190lb-50101 - Up To H.N 91150
Avant - A Partir Du 190lb-50101 - Jusqu'au H.N 91150
Vorne - Ab Den 190lb-50101 - Bis Den H.N 91150
Anteriore - Dalla 190lb-50101 - Fino Alla H.N 91150
Delantero - A Partir Del 190lb-50101 - Hasta H.N 91150

5-BA17-034-E

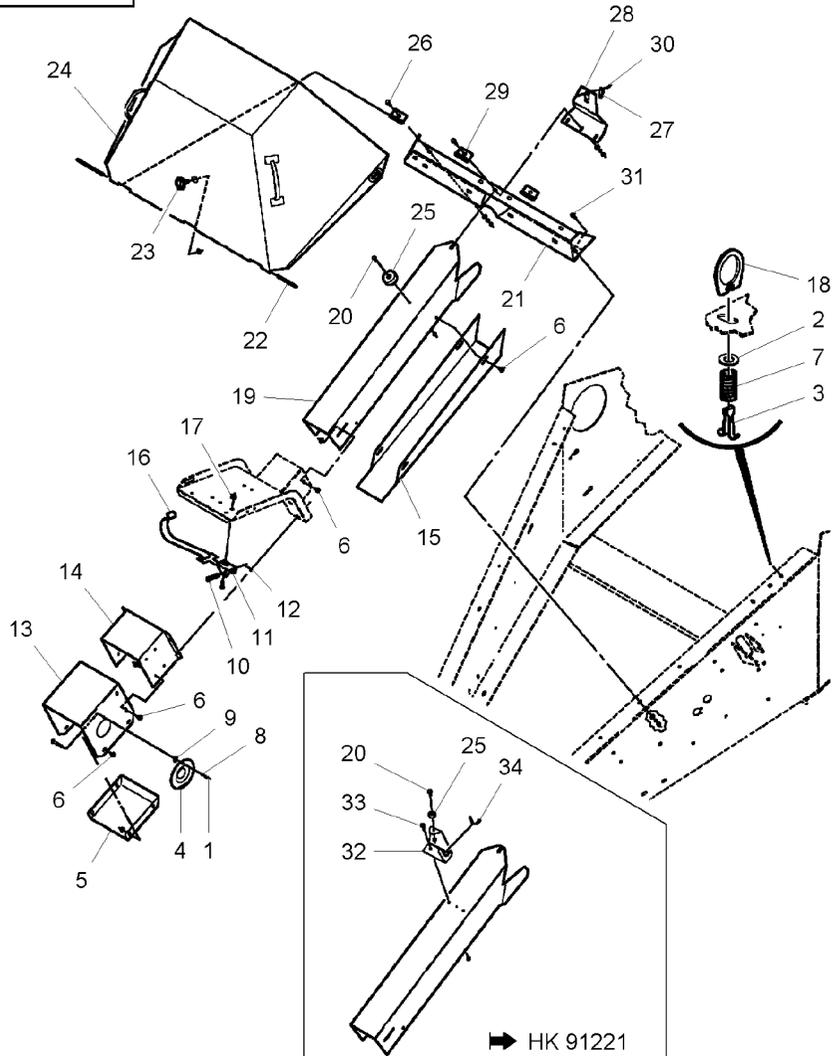

1★70922127	5/16"-18 X 1-3/4	1 CAPSCREW	VIS BOUCHON	HUTSCHRAUBE
1★Y705525	5/16"	1 WASHER	TAPPO A VITE	TORNILLO TAPON
1★Y704726	5/16"-18	1 LOCKNUT	RONDELLE	UNTERLEGSCHIEBE
2★Y705525	5/16"	1 WASHER	RONDELLE	ARANDELA
3★7894975		1 CLIP	ECROU BLOCCAGE	SICHERUNGSMUTTER
4★700133083		1 SHIELD	AUTOBLOCCANTE	CONTRATUERCA
5★700133732		1 SHIELD	RONDELLE	UNTERLEGSCHIEBE
6★7883317	5/16"-18 X 1/2	14 SCREW	RONDELLE	ARANDELA
6★70931277	5/16"-18	14 NUT	CLIP	SHELLE
7★7758212		1 SPRING	FERMAGLIO	CLIP
8★758342		1 COMP.SPRING	TOLE	SCHILD
9★700709866		1 WASHER	RIPARO	BLINDAJE
10★863381	3/8" X 2	1 CLEVIS PIN	TOLE	SCHILD
11★700150655		1 CHANNEL	RIPARO	BLINDAJE
12★70918455	5/32" X 3/4	1 PIN	VIS	SCHRAUBE
13★700133731P		1 SHIELD	VITE	TORNILLO
14★700114012P		1 SHIELD	ECROU	MUTTER
15★700133735		1 SHIELD	DADO	TUERCA
16★700134443		1 SUPPORT	RESSORT	FEDER
17★70922786	3/8"-16 X 1	1 BOLT	MOLLA	RESORTE
17★700711238	3/8"-16	1 LOCKNUT	RESSORT DE COMPR	DRUCKFEDER
18★7894967		1 HANDLE	MOLLA COMPOSTA	RESORTE DE COMP.
19★700133733		1 SHIELD	RONDELLE	UNTERLEGSCHIEBE
20★700707203	No 12-24 X 3/4	1 SCREW	RONDELLE	ARANDELA
20★373839X1	No 12-24	1 NUT	AXE	SPLINTBOLZEN
21★700133740P		1 CHANNEL	PERNO D'ATTACCO	BULON CILINDRICO
			CANAL	KANAL
			PROFILATO	CANAL
			GOUILLE	BOLZEN
			PERNO	PASADOR
			TOLE	SCHILD
			RIPARO	BLINDAJE
			TOLE	SCHILD
			RIPARO	BLINDAJE
			TOLE	SCHILD
			RIPARO	BLINDAJE
			SUPPORT	LAGERUNG
			SUPPORTO	DISPOS.DE SOSTEN
			BOULON	MASCH.SCHRAUBE
			BULLONE	ESPIGA/BULON
			ECROU BLOCCAGE	SICHERUNGSMUTTER
			AUTOBLOCCANTE	CONTRATUERCA
			POIGNEE	HANDGRIFF
			MANIGLIA	MANETA
			TOLE	SCHILD
			RIPARO	BLINDAJE
			VIS	SCHRAUBE
			VITE	TORNILLO
			ECROU	MUTTER
			DADO	TUERCA
			CANAL	KANAL
			PROFILATO	CANAL

Shields
Garants
Schutzbleche
Difese
Proteccionee

60-20

Front - From 190lb-50101 - Up To H.N 91150
 Avant - A Partir Du 190lb-50101 - Jusqu'au H.N 91150
 Vorne - Ab Den 190lb-50101 - Bis Den H.N 91150
 Anteriore - Dalla 190lb-50101 - Fino Alla H.N 91150
 Delantero - A Partir Del 190lb-50101 - Hasta H.N 91150

5-BA17-034-E

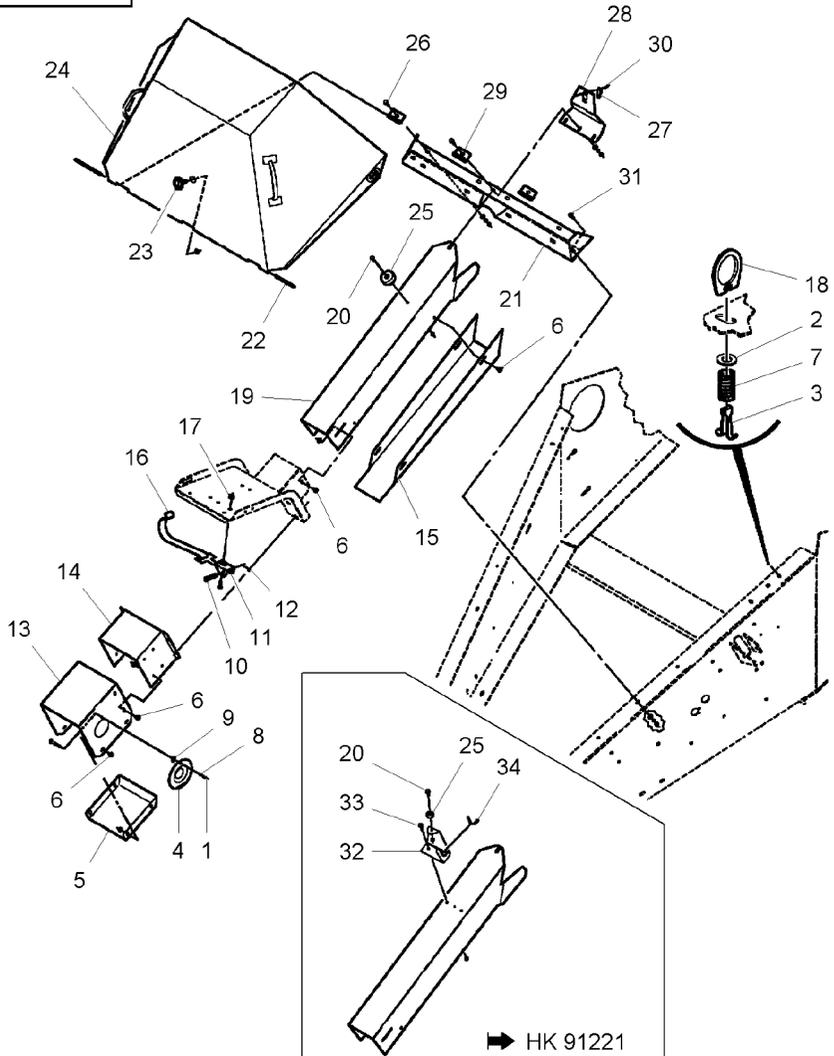

22★65052		1 PIN	GOUILLE	BOLZEN
23★700714528		1 LATCH	PERNO	PASADOR
24★700133741		1 SHIELD	VERROU	RIEGEL
25★700708648		1 BUMPER	CHIAVISTELLO	CERROJO
26★7883333	5/16"-18 X 1	5 SCREW	TOLE	SCHILD
26★Y705525	5/16"	5 WASHER	RIPARO	BLINDAJE
26★70917356	5/16"	5 LOCK WASHER	PARE CHOC	STOSSFAENGER
26★Y704015	5/16"-18	5 NUT	PARAURTI	PARAGOLPES
27★700714529		1 RECEIVER	VIS	SCHRAUBE
28★700133737		1 SUPPORT	VITE	TORNILLO
29★700113994		3 SUPPORT	RONDELLE	UNTERLEGSCHIEBE
30★700700628	No 10-24 X 1/2	2 SCREW	RONDELLA	ARANDELA
30★70917380	NO 10	2 WASHER	RONDELLE FREIN	FEDERRING
30★705004	NO 10	2 LOCK WASHER	ROSETTA DENTELL.	ARANDELA GROWER
30★354120X1	NO 10-24	2 NUT	ECROU	MUTTER
31★7883325	5/16"-18 X 3/4	2 SCREW	DADO	TUERCA
31★Y705525	5/16"	2 WASHER	VIS	SCHRAUBE
31★70917356	5/16"	2 LOCK WASHER	VITE	TORNILLO
31★Y704015	5/16"-18	2 NUT	RONDELLE	UNTERLEGSCHIEBE
32★700138852	➡ HK 91221	1 SUPPORT	RONDELLA	ARANDELA
33★7883382	➡ HK 91221	2 SCREW	RONDELLE FREIN	FEDERRING
33★704247	➡ HK 91221	2 NUT	ROSETTA DENTELL.	ARANDELA GROWER
34★6477723	➡ HK 91221	1 GROMMET	ECROU	MUTTER
			DADO	TUERCA
			PASSE FIL	GUMMITUELLE
			ANELLO PASSACAVO	PASACABLE

Shields
 Garants
 Schutzbleche
 Difese
 Protezionee

60-25

Front - From H.N 91151
 Avant - A Partir Du H.N 91151
 Vorne - Ab H.N 91151
 Anteriore - Dalla H.N 91151
 Delantero - A Partir Del H.N 91151

5-BA17-102-A

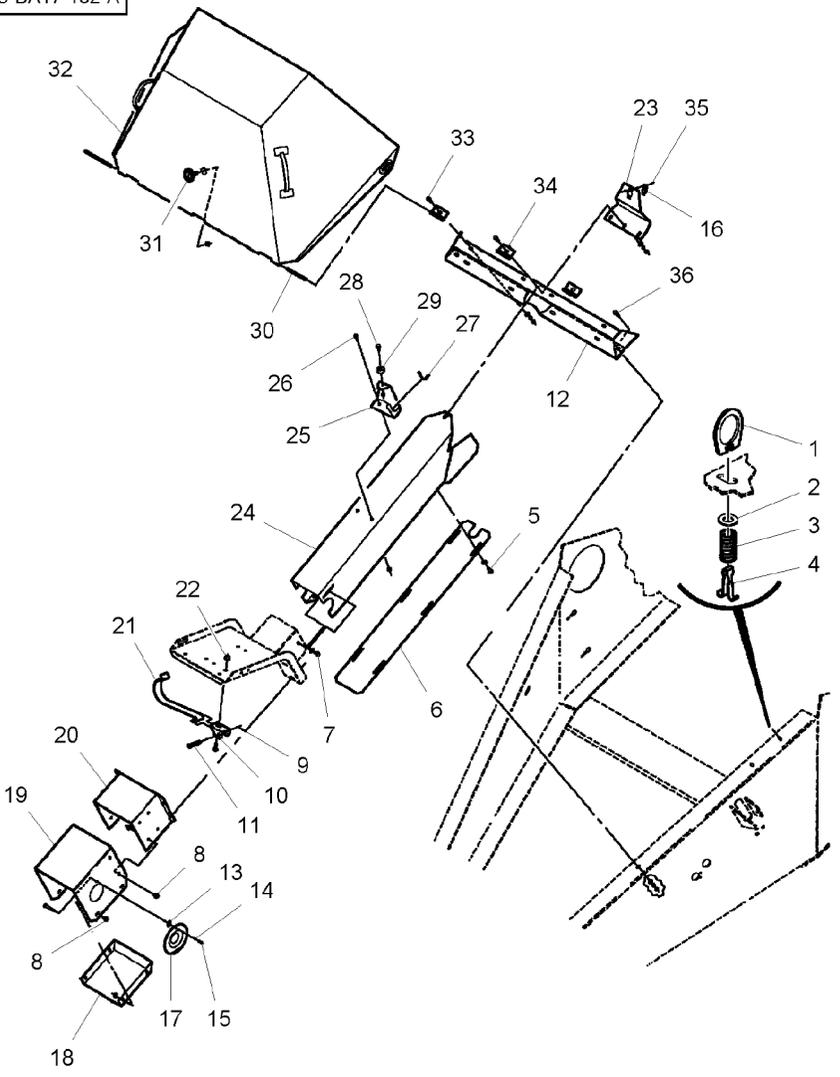

1	★7894967		1 HANDLE	POIGNEE	HANDGRIFF
2	★Y705525	5/16"	1 WASHER	MANIGLIA	MANETA
3	★7758212		1 SPRING	RONDELLE	UNTERLEGSCHIEBE
4	★7894975		1 CLIP	RONDELLE	ARANDELA
5	★7883317	5/16"-18 X 1/2	6 SCREW	RESSORT	FEDER
5	★Y705525	5/16"	6 WASHER	MOLLA	RESORTE
6	★700153226P		1 SHIELD	CLIP	SCHELLE
7	★7883366	3/8"-16 X 1/2	2 SCREW	FERMAGLIO	CLIP
7	★Y705533	3/8"	2 WASHER	VIS	SCHRAUBE
8	★7883317	5/16"-18 X 1/2	5 SCREW	VITE	TORNILLO
8	★70931277	5/16"-18	5 NUT	RONDELLE	UNTERLEGSCHIEBE
9	★70918455	5/32" X 3/4	1 PIN	RONDELLE	ARANDELA
10	★700150655		1 CHANNEL	RONDELLE	ARANDELA
11	★863381	3/8" X 2	1 CLEVIS PIN	VIS	SCHRAUBE
12	★700133740P		1 CHANNEL	VITE	TORNILLO
13	★700709866		1 WASHER	ECROU	MUTTER
14	★758342		1 COMP.SPONG	DADO	TUERCA
15	★70922127	5/16"-18 X 1-3/4	1 CAPSCREW	GOUILLE	BOLZEN
15	★Y705525	5/16"	1 WASHER	PERNO	PASADOR
15	★Y704726	5/16"-18	1 LOCKNUT	CANAL	KANAL
16	★700714529		1 RECEIVER	PROFILATO	CANAL
17	★700133083		1 SHIELD	AXE	SPLINTBOLZEN
18	★700133732		1 SHIELD	PERNO D'ATTACCO	BULON CILINDRICO
19	★700133731P		1 SHIELD	CANAL	KANAL
20	★700114012P		1 SHIELD	PROFILATO	CANAL
21	★700134443		1 SUPPORT	RONDELLE	UNTERLEGSCHIEBE
				RONDELLE	ARANDELA
				RESSORT DE COMPR	DRUCKFEDER
				MOLLA COMPOSTA	RESORTE DE COMP.
				VIS BOUCHON	HUTSCHRAUBE
				TAPPO A VITE	TORNILLO TAPON
				RONDELLE	UNTERLEGSCHIEBE
				RONDELLE	ARANDELA
				ECROU BLOCCAGE	SICHERUNGSMUTTER
				AUTOBLOCCANTE	CONTRATUERCA
				RECEVEUR	EMPAENGER
				RICEVITORE	RECEPTOR
				TOLE	SCHILD
				RIPARO	BLINDAJE
				TOLE	SCHILD
				RIPARO	BLINDAJE
				TOLE	SCHILD
				RIPARO	BLINDAJE
				TOLE	SCHILD
				RIPARO	BLINDAJE
				SUPPORT	LAGERUNG
				SUPPORTO	DISPOS.DE SOSTEN

Shields
Garants
Schutzbleche
Difese
Proteccionee

60-25

Front - From H.N 91151
Avant - A Partir Du H.N 91151
Vorne - Ab H.N 91151
Anteriore - Dalla H.N 91151
Delantero - A Partir Del H.N 91151

5-BA17-102-A

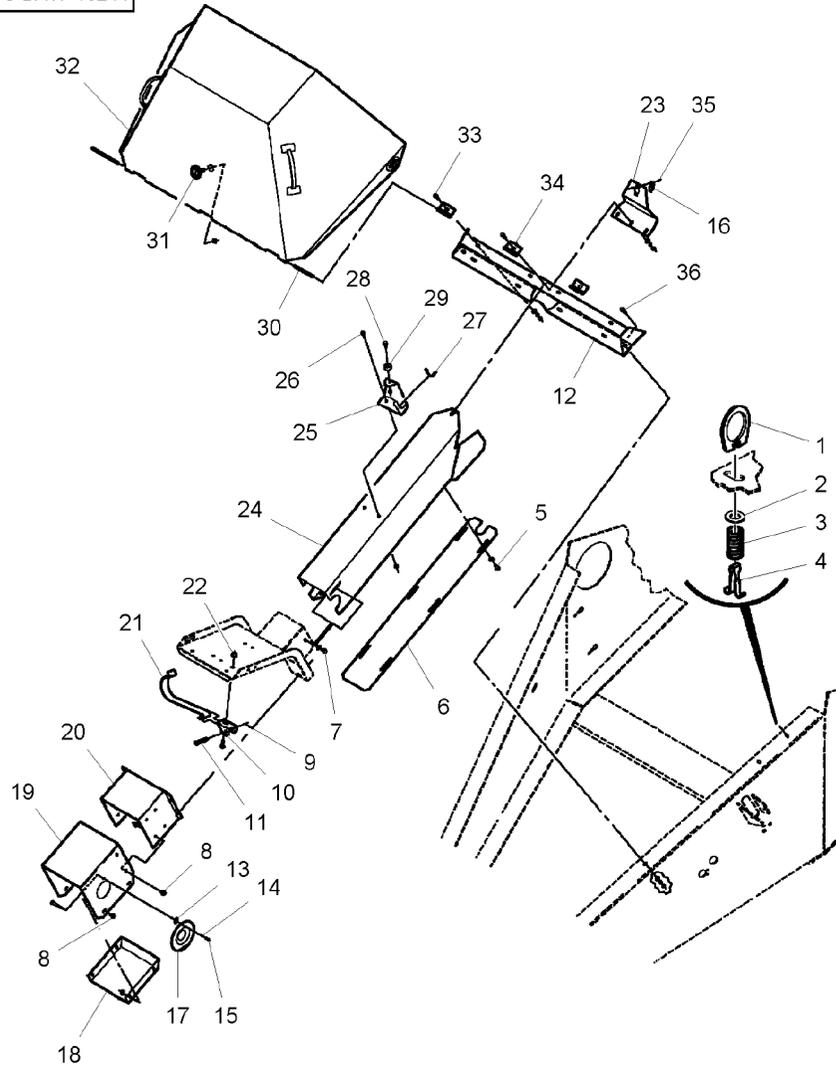

22★70922786	3/8"-16 X 1	1 BOLT	BOULON	MASCH.SCHRAUBE
22★700711238	3/8"-16	1 LOCKNUT	BULLONE	ESPIGA/BULON
23★700133737		1 SUPPORT	ECROU BLOCAGE	SICHERUNGSMUTTER
24★700153227M		1 SHIELD	AUTOBLOCCANTE	CONTRATUERCA
25★700138852		1 SUPPORT	SUPPORT	LAGERUNG
26★7883382	3/8"-16 X 1	2 SCREW	SUPPORTO	DISPOS.DE SOSTEN
26★704247	3/8"-16	2 NUT	TOLE	SCHILD
27★6477723		1 GROMMET	RIPARO	BLINDAJE
28★700707203	No 12-24 X 3/4	1 SCREW	SUPPORT	LAGERUNG
28★373839X1	No 12-24	1 NUT	SUPPORTO	DISPOS.DE SOSTEN
29★700708648		1 BUMPER	SUPPORTO	DISPOS.DE SOSTEN
30★65052		1 PIN	VIS	SCHRAUBE
31★700714528		1 LATCH	VITE	TORNILLO
32★700133741		1 SHIELD	DADO	TUERCA
33★7883333	5/16"-18 X 1	5 SCREW	PASSE FIL	GUMMITUELLE
33★Y705525	5/16"	5 WASHER	ANELLO PASSACAVO	PASACABLE
33★70917356	5/16"	5 LOCK WASHER	VIS	SCHRAUBE
33★Y704015	5/16"-18	5 NUT	VITE	TORNILLO
34★700113994		3 SUPPORT	ECROU	MUTTER
35★700700628	No 10-24 X 1/2	2 SCREW	DADO	TUERCA
35★70917380	No 10	2 WASHER	SUPPORT	LAGERUNG
35★70926673	No 10-24	2 NUT	SUPPORTO	DISPOS.DE SOSTEN
36★7883325	5/16"-18 X 3/4	2 SCREW	VIS	SCHRAUBE
36★Y705525	5/16"	2 WASHER	VITE	TORNILLO
36★70917356	5/16"	2 LOCK WASHER	RONDELLE	UNTERLEGSCHIEBE
36★Y704015	5/16"-18	2 NUT	RONDELLA	ARANDELA
			RONDELLE FREIN	ARANDELA
			ROSETTA DENTELL.	FEDERRING
			ECROU	MUTTER
			DADO	TUERCA

Shields
Garants
Schutzbleche
Difese
Proteccionee

60-30

Upper Components
Partie Superieure
Oberer Teil
Parte Superior
Partido Superior

5-BA17-010-D

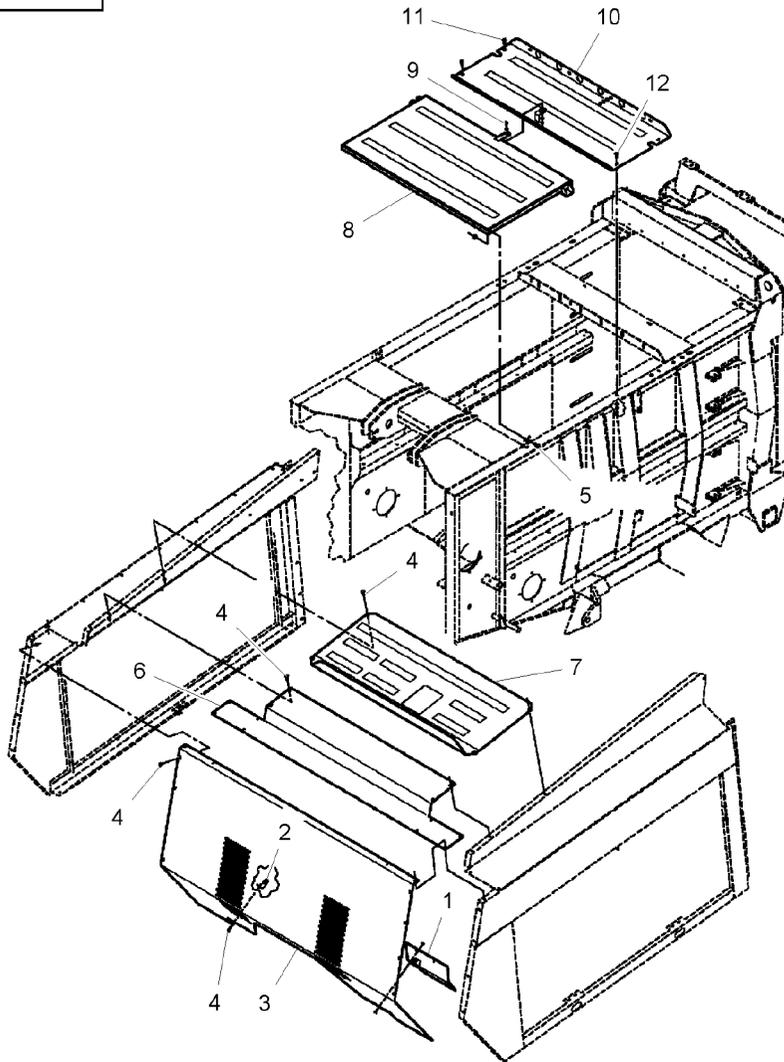

1 ★700150685P		1 SUPPORT	SUPPORT	LAGERUNG
2 ★700114022		2 CHANNEL	SUPPORTO	DISPOS.DE SOSTEN
3 ★700113952	➡ 190LB-50214	1 SHIELD	CANAL	KANAL
3 ★700150690	➡ 190LB-50215	1 SHIELD	PROFILATO	CANAL
4 ★7883325	5/16"-18 X 3/4	30 SCREW	TOLE	SCHILD
4 ★70931277	5/16"-18	30 NUT	RIPARO	BLINDAJE
5 ★70923114	1/2"-13 X 1	2 CAPSCREW	RIPARO	SCHILD
5 ★704858	1/2"-13	2 LOCKNUT	RIPARO	BLINDAJE
6 ★700113953P		1 SHIELD	VIS	SCHRAUBE
7 ★700133635		1 SHIELD	VITE	TORNILLO
8 ★700122886P	➡ 190LB-50100	1 LID	ECROU	MUTTER
8 ★700133709	➡ 190LB-50101	1 LID	DADO	TUERCA
9 ★70921332	5/16"-18 X 3/4	1 CAPSCREW	VIS BOUCHON	HUTSCHRAUBE
9 ★Y705525	5/16"	2 WASHER	TAPPO A VITE	TORNILLO TAPON
9 ★704486	5/16"-18	1 NUT	ECROU BLOCAGE	SICHERUNGSMUTTER
10 ★700113988P	➡ 190LB-50100	1 CHANNEL	AUTOBLOCCANTE	CONTRATUERCA
10 ★700133711	➡ 190LB-50101	1 CHANNEL	TOLE	SCHILD
11 ★7883382	3/8"-16 X 1	2 SCREW	RIPARO	BLINDAJE
11 ★Y705533	3/8"	2 WASHER	TOLE	SCHILD
11 ★70916965	3/8"	2 LOCK WASHER	RIPARO	BLINDAJE
11 ★70916950	3/8"-16	2 NUT	PLAQUE COUVERCLE	ABDECKPLATTE
12 ★70922786	3/8"-16 X 1	6 BOLT	COPERTA	COBERTURA
12 ★Y705533	3/8	6 WASHER	PLAQUE COUVERCLE	ABDECKPLATTE
12 ★70916965	3/8"	6 LOCK WASHER	COPERTA	COBERTURA
12 ★70916950	3/8"-16	6 NUT	VIS BOUCHON	HUTSCHRAUBE
			TAPPO A VITE	TORNILLO TAPON
			RONDELLE	UNTERLEGSCHIEBE
			RONDELLA	ARANDELA
			ECROU	MUTTER
			DADO	TUERCA
			CANAL	KANAL
			PROFILATO	CANAL
			CANAL	KANAL
			PROFILATO	CANAL
			VIS	SCHRAUBE
			VITE	TORNILLO
			RONDELLE	UNTERLEGSCHIEBE
			RONDELLA	ARANDELA
			RONDELLE FREIN	FEDERRING
			ROSETTA DENTELL.	ARANDELA GROWER
			ECROU	MUTTER
			DADO	TUERCA
			BOULON	MASCH.SCHRAUBE
			BULLONE	ESPIGA/BULON
			RONDELLE	UNTERLEGSCHIEBE
			RONDELLA	ARANDELA
			RONDELLE FREIN	FEDERRING
			ROSETTA DENTELL.	ARANDELA GROWER
			ECROU	MUTTER
			DADO	TUERCA

Shields
Garants
Schutzbleche
Difese
Proteccionee

60-35

Left Side - Up To 190lb-50100
Cote Gauche - Jusqu'au 190lb-50100
Linke Seite - Bis 190lb-50100
Lato Sinistro - Fino Alla 190lb-50100
Lado Izquierdo - Hasta 190lb-50100

5-BA17-011-A

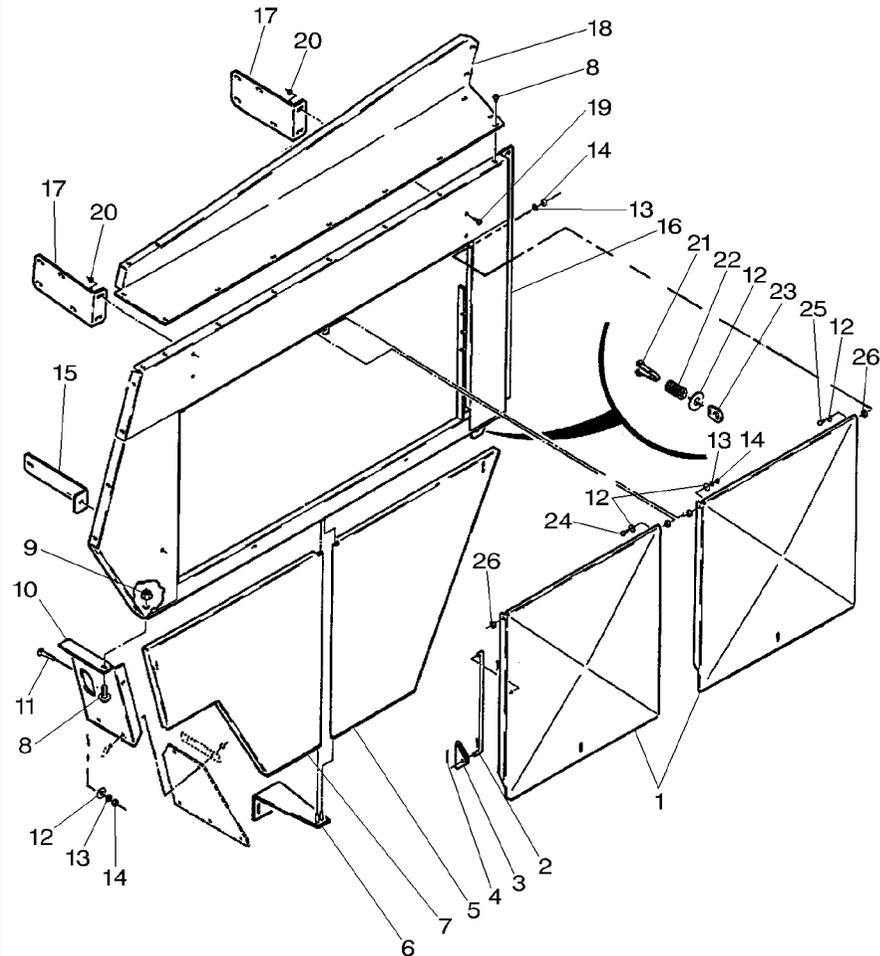

1	700113975		2	DOOR	PORTIERE	TUER
2	700113991		2	ROD	PORTA	PUERTA
3	700113992		2	GUIDE	TRINGLE	STANGE
4	354057X1	1/8" X 3/4			ASTA	VARILLA
5	700113982		6	SPLIT PIN	GUIDE	FUEHRUNG
6	700113997P				GUIDA	GUIA
7	700113980		1	SHIELD	GOUILLE FENDUE	SPALTBOLZEN
8	7883325	5/16"-18 X 3/4	1	SUPPORT	COPIGLIA	PASADOR HENDIDO
9	70931277	5/16"-18	1	SHIELD	TOLE	SCHILD
10	700113995		1	SUPPORT	RIPARO	BLINDAJE
11	364534X1	5/16"-18 X 1	1	SHIELD	SUPPORTO	LAGERUNG
12	Y705525	5/16"	1	SHIELD	SUPPORTO	DISPOS.DE SOSTEN
13	353446X1	5/16"	1	SHIELD	TOLE	SCHILD
14	355565X1	5/16"-18	1	SHIELD	RIPARO	BLINDAJE
15	700113990P		8	SCREW	VIS	SCHRAUBE
16	700113954		8	NUT	VITE	TORNILLO
17	700113989P		8	NUT	ECROU	MUTTER
18	700113973M		1	SHIELD	DADO	TUERCA
19	7883382	3/8"-16 X 1	1	SHIELD	TOLE	SCHILD
20	704247	3/8"-16	1	SHIELD	RIPARO	BLINDAJE
21	7894975		2	BOLT	BOULON	MASCH.SCHRAUBE
22	7758212		10	WASHER	BULLONE	ESPIGA/BULON
23	7894967				RONDELLE	UNTERLEGSCHIBE
24	353681X1	5/16"-18 X 1-1/4	5	LOCK WASHER	RONDELLA	ARANDELA
25	70922925	5/16"-18 X 3/4			RONDELLE FREIN	FEDERRING
26	6514772		5	NUT UNC	ROSETTA DENTELL.	ARANDELA GROWER
					ECROU UNC	MUTTER UNC
			1	ANGLE.	DADO UNC	TUERCA UNC
			1	SHIELD	EQUERRE	WINKEL
			1	SHIELD	ANGOLO	ANGULO
			2	ANGLE.	TOLE	SCHILD
			1	SHIELD	RIPARO	BLINDAJE
			10	SCREW	EQUERRE	WINKEL
			10	NUT	ANGOLO	ANGULO
			4	CLIP	TOLE	SCHILD
			4	SPRING	RIPARO	BLINDAJE
			4	HANDLE	EQUERRE	WINKEL
			1	BOLT UNC	ANGOLO	ANGULO
			1	BOLT UNC	TOLE	SCHILD
			2	CAPSCREW	RIPARO	BLINDAJE
			4	SPACER	VIS	SCHRAUBE
					VITE	TORNILLO
					DADO	TUERCA
					CLIP	SHELLE
					FERMAGLIO	CLIP
					RESSORT	FEDER
					MOLLA	RESORTE
					POIGNEE	HANDGRIF
					MANIGLIA	MANETA
					BOULON UNC	MASCH.SCHRB.UNC
					BULLONE UNC	PERNO UNC
					VIS BOUCHON	HUTSCHRAUBE
					TAPPO A VITE	TORNILLO TAPON
					ENTRETOISE	ABSTANDSTUECK
					DISTANZIALE	DISCO ESPACIADOR

Shields
Garants
Schutzbleche
Difese
Proteccionee

60-40

Left Side - From 190lb-50101
Cote Gauche - A Partir Du 190lb-50101
Linke Seite - Ab 190lb-50101
Lato Sinistro - Dalla 190lb-50101
Lado Izquierdo - A Partir Del 190lb-50101

5-BA17-031-B

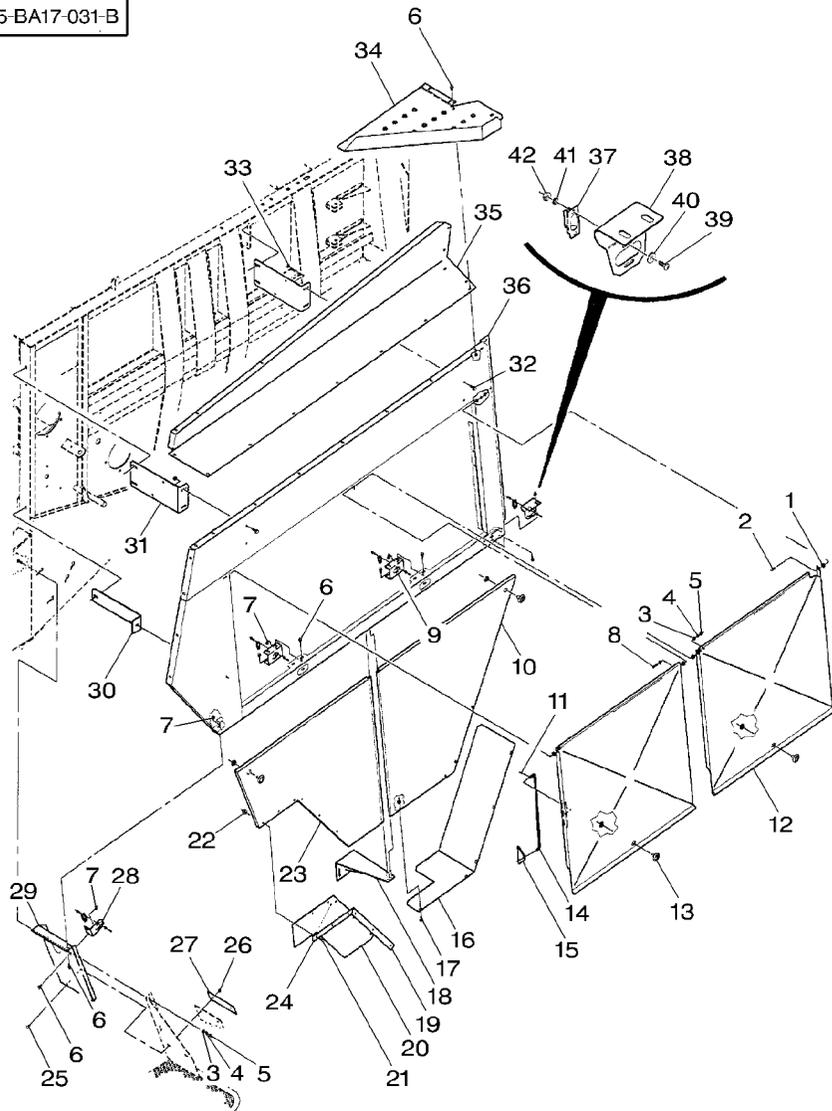

1	6514772		4	SPACER	ENTRETOISE	ABSTANDSTUECK
2	★70921332	5/16"-18 X 3/4	2	CAPSCREW	DISTANZIALE	DISCO ESPACIADOR
3	Y705525	5/16"			VIS BOUCHON	HUTSCHRAUBE
4	★70917356	5/16"	6	WASHER	TAPPO A VITE	TORNILLO TAPON
5	Y704015	5/16"-18			RONDELLE	UNTERLEGSCHIEBE
6	7883325	5/16"-18 X 3/4	10	LOCK WASHER	RONDELLE	ARANDELA
7	70931277	5/16"-18			RONDELLE FREIN	FEDERRING
8	★70921977	5/16"-18 X 1-1/4	10	NUT	ROSETTA DENTELL.	ARANDELA GROWER
9	700133106P				ECROU	MUTTER
10	★700133626		38	SCREW	DADO	TUERCA
11	★70918451	1/8" X 3/4			VIS	SCHRAUBE
12	★700133624		38	NUT	VITE	TORNILLO
13	700714528				ECROU	MUTTER
14	700113991		1	CAPSCREW	DADO	TUERCA
15	700113992				VIS BOUCHON	HUTSCHRAUBE
16	★700121720		2	CHANNEL	TAPPO A VITE	TORNILLO TAPON
17	7700461	5/16"-18 X 3/4			CANAL	KANAL
18	700113997P		1	SHIELD	PROFILATO	CANAL
19	★700121722				TOLE	SCHILD
20	700709979		1	SHIELD	RIPARO	BLINDAJE
21	★7700578	5/16"-18 X 1	6	PIN	GOUPILLE	BOLZEN
22	Y704726	5/16"-18			PERNO	PASADOR
23	700133630P		2	DOOR	PORTIERE	TUER
24	★700121724				PORTA	PUERTA
25	★7700461	5/16"-18 X 3/4	4	LATCH	VERROU	RIEGEL
26	Y704163	5/16"-18			CHIAVISTELLO	CERROJO
			2	ROD	TRINGLE	STANGE
					ASTA	VARILLA
			2	GUIDE	GUIDE	FUEHRUNG
					GUIDA	GUIA
			1	SHIELD	TOLE	SCHILD
			5	BOLT	RIPARO	BLINDAJE
					BOULON	MASCH.SCHRAUBE
			1	SUPPORT	BULLONE	ESPIGA/BULON
					SUPPORT	LAGERUNG
			1	SUPPORT	SUPPORTO	DISPOS.DE SOSTEN
					SUPPORT	LAGERUNG
			1	SHIELD	SUPPORTO	DISPOS.DE SOSTEN
					TOLE	SCHILD
			8	SCREW	RIPARO	BLINDAJE
					VIS	SCHRAUBE
			6	LOCKNUT	VITE	TORNILLO
					ECROU BLOCAGE	SICHERUNGSMUTTER
			1	SHIELD	AUTOBLOCCANTE	CONTRATUERCA
					TOLE	SCHILD
			1	SUPPORT	RIPARO	BLINDAJE
					SUPPORT	LAGERUNG
			1	SUPPORT	SUPPORTO	DISPOS.DE SOSTEN
					BOULON	MASCH.SCHRAUBE
			2	BOLT	BULLONE	ESPIGA/BULON
					ECROU	MUTTER
			2	NUT	DADO	TUERCA

Shields
Garants
Schutzbleche
Difese
Proteccionee

60-40

Left Side - From 190lb-50101
Cote Gauche - A Partir Du 190lb-50101
Linke Seite - Ab 190lb-50101
Lato Sinistro - Dalla 190lb-50101
Lado Izquierdo - A Partir Del 190lb-50101

5-BA17-031-B

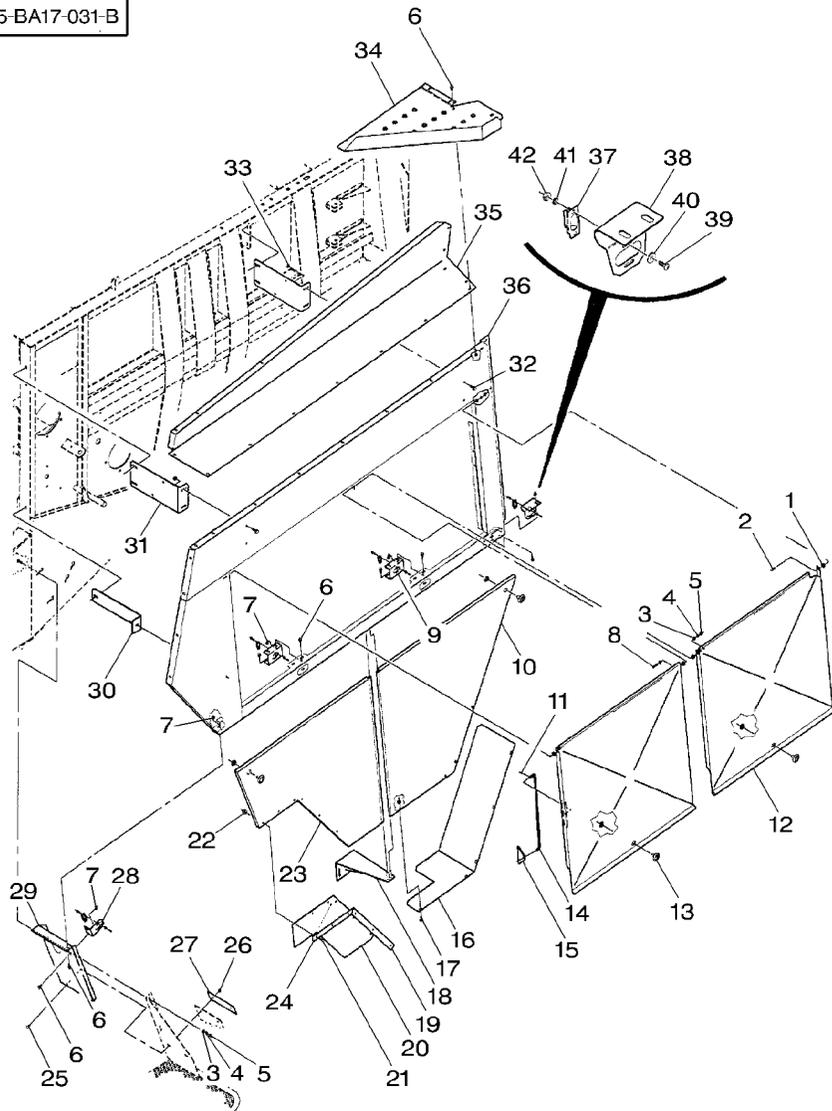

27	700121497		1	STRAP	PATTE	LASCHE
28	700133628		1	ANGLE.	CORREGGIA	FAJA
29	700133632	➡ 190LB-50214	1	SHIELD	EQUERRE	WINKEL
29*	700150689	➡ 190LB-50215	1	SHIELD	ANGOLO	ANGULO
30	700113990P		1	ANGLE.	TOLE	SCHILD
31	700113989P		2	ANGLE.	RIPARO	BLINDAJE
32	7883382	3/8"-16 X 1	10	SCREW	TOLE	SCHILD
33	704247	3/8"-16	10	NUT	RIPARO	BLINDAJE
34	700133634P		1	PANEL	RIPARO	BLINDAJE
35	700152204P		1	SHIELD	EQUERRE	WINKEL
36*	700133691B	➡ 190LB-50214	1	SHIELD	ANGOLO	ANGULO
36	700150687	➡ 190LB-50215	1	SHIELD	EQUERRE	WINKEL
37	700714529		4	RECEIVER	ANGOLO	ANGULO
38*	700133623		1	MOUNTING	ANGULO	ANGULO
39	700700628	No 10-24 X 1/2	8	SCREW	ANGULO	ANGULO
40	70917380	No 10	8	WASHER	VITE	TORNILLO
41*	705004	No 10	8	LOCK WASHER	ECROU	MUTTER
42*	354120X1	No 10-24	8	NUT	DADO	TUERCA

Shields
Garants
Schutzbleche
Difese
Proteccionee

60-45

Right Side - Up To 190lb-50100
Cote Droit - Jusqu'au 190lb-50100
Rechte Seite - Bis 190lb-50100
Lado Destra - Fino Alla 190lb-50100
Lado Derecho - Hasta 190lb-50100

5-BA17-012-A

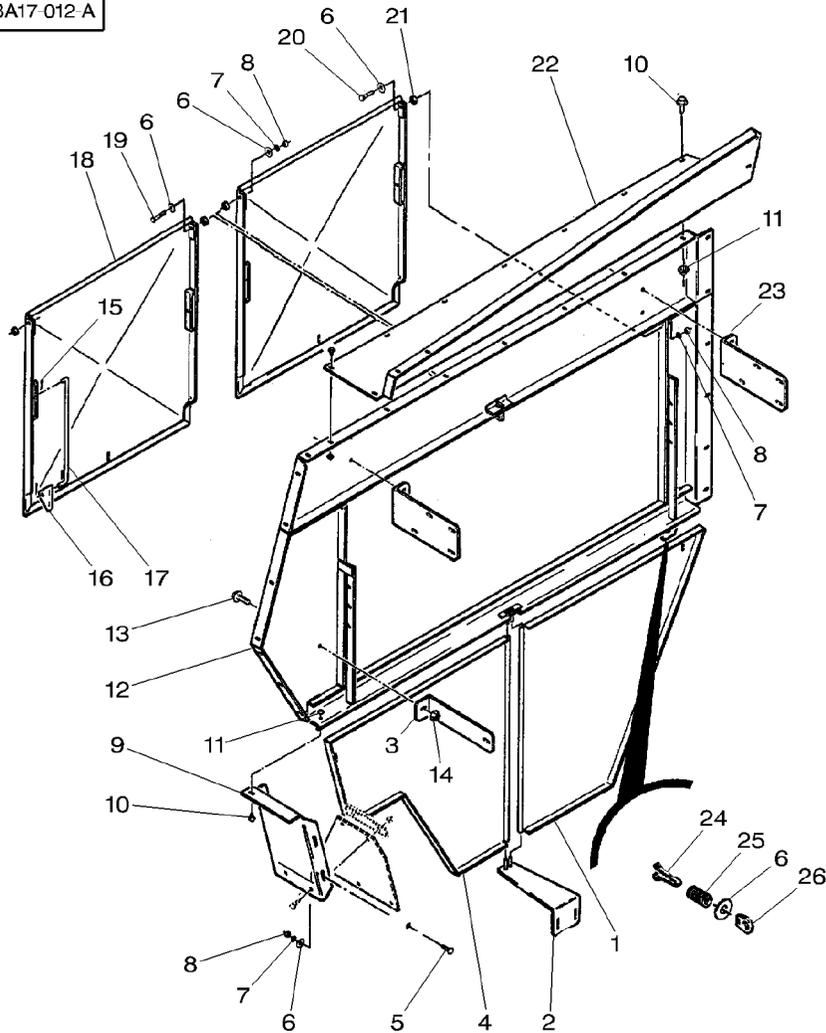

1	700113983		1 SHIELD	TOLE	SCHILD
2	700113997P		1 SUPPORT	RIPARO SUPPORTO	BLINDAJE LAGERUNG
3	700113990P		1 ANGLE.	SUPPORTO EQUERRE	DISPOS.DE SOSTEN WINKEL
4	700113981		1 SHIELD	ANGOLO TOLE	ANGULO SCHILD
5	364534X1	5/16"-18 X 1	2 BOLT	RIPARO BOULON	BLINDAJE MASCH.SCHRAUBE
6	Y705525	5/16"	10 WASHER	BULLONE RONDELLE	ESPIGA/BULON UNTERLEGSCHIEBE
7	353446X1	5/16"	5 LOCK WASHER	RONDELLA RONDELLE FREIN	ARANDELA FEDERRING
8	355565X1	5/16"-18	5 NUT UNC	ROSETTA DENTELL. ECROU UNC	ARANDELA GROWER MUTTER UNC
9	700113996		1 SHIELD	DADO UNC	TUERCA UNC
10	7883325	5/16"-18 X 3/4	8 SCREW	TOLE RIPARO	SCHILD BLINDAJE
11	70931277	5/16"-18	8 NUT	VIS VITE	SCHRAUBE TORNILLO
12	700113955		1 SHIELD	ECROU DADO	MUTTER TUERCA
13	7883382	3/8"-16 X 1	10 SCREW	TOLE RIPARO	SCHILD BLINDAJE
14	704247	3/8"-16	10 NUT	VIS VITE	SCHRAUBE TORNILLO
15	354057X1	1/8" X 3/4	6 SPLIT PIN	ECROU DADO	MUTTER TUERCA
16	700113992		2 GUIDE	GOUPILLE FENDUE COPIGLIA	SPALTBOLZEN PASADOR HENDIDO
17	700113991		2 ROD	GUIDE GUIDA	FUEHRUNG GUIA
18	700113975		2 DOOR	TRINGLE ASTA	STANGE VARILLA
19	353681X1	5/16"-18 X 1-1/4	1 BOLT UNC	PORTIERE PORTA	TUER PUERTA
20	70922925	5/16"-18 X 3/4	2 CAPSCREW	BOULON UNC BULLONE UNC	MASCH.SCHRB.UNC PERNO UNC
21	6514772		4 SPACER	VIS BOUCHON TAPPO A VITE	HUTSCHRAUBE TORNILLO TAPON
22	700113974M		1 SHIELD	ENTRETOISE DISTANZIALE	ABSTANDSTUECK DISCO ESPACIADOR
23	700113989P		2 ANGLE.	TOLE RIPARO	SCHILD BLINDAJE
24	7894975		4 CLIP	EQUERRE ANGOLO	WINKEL ANGULO
25	7758212		4 SPRING	CLIP FERMAGLIO	SHELLE CLIP
26	7894967		4 HANDLE	RESSORT MOLLA	FEDER RESORTE
				POIGNEE MANIGLIA	HANDGRIFF MANETA

Shields
Garants
Schutzbleche
Difese
Proteccionee

60-50

Right Side - From 190lb-50101
Cote Droit - A Partir Du 190lb-50101
Rechte Seite - Ab 190lb-50101
Lado Sinistro - Dalla 190lb-50101
Lado Izquierdo - A Partir Del 190lb-50101

5-BA17-032-A

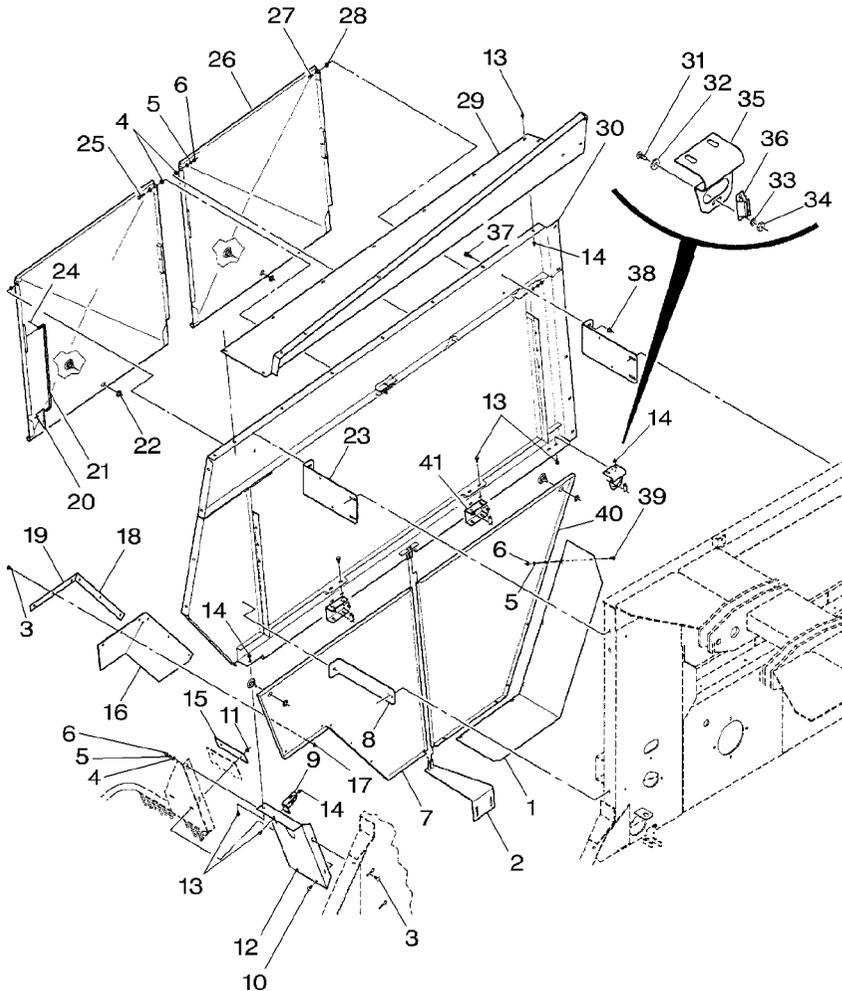

1	★700121721		1 SHIELD	TOLE	SCHILD
2	700113997P		1 SUPPORT	RIPARO SUPPORT SUPPORTO	BLINDAJE LAGERUNG DISPOS.DE SOSTEN
3	★7700578	5/16"-18 X 1	8 SCREW	VIS VITE	SCHRAUBE TORNILLO
4	Y705525	5/16"	6 WASHER	RONDELLE RONDELLA RONDELLE FREIN ROSETTA DENTELL.	UNTERLEGSCHIEBE ARANDELA FEDERRING ARANDELA GROWER
5	★70917356	5/16"	10 LOCK WASHER	ECROU DADO	MUTTER TUERCA
6	Y704015	5/16"-18	10 NUT	TOLE RIPARO EQUERRE ANGOLO	SCHILD BLINDAJE WINKEL ANGULO
7	★700133631		1 SHIELD	TOLE	SCHILD
8	700113990P		1 ANGLE.	RIPARO EQUERRE ANGOLO	BLINDAJE WINKEL ANGULO
9	700133628		1 ANGLE.	EQUERRE ANGOLO	WINKEL ANGULO
10	★7700461	5/16"-18 X 3/4	2 BOLT	BOULON BULLONE	MASCH.SCHRAUBE ESPIGA/BULON
11	Y704163	5/16"-18	2 NUT	ECROU DADO	MUTTER TUERCA
12	700133633P		1 SHIELD	TOLE RIPARO	SCHILD BLINDAJE
13	7883325	5/16"-18 X 3/4	36 SCREW	VIS VITE	SCHRAUBE TORNILLO
14	70931277	5/16"-18	36 NUT	ECROU DADO	MUTTER TUERCA
15	700121497		1 STRAP	PATTE CORREGGIA	LASCHE FAJA
16	700709979		1 SHIELD	TOLE RIPARO	SCHILD BLINDAJE
17	Y704726	5/16"-18	6 LOCKNUT	ECROU BLOCAGE AUTOBLOCCANTE	SICHERUNGSMUTTER CONTRATUERCA
18	★700121722		1 SUPPORT	SUPPORT SUPPORTO	LAGERUNG DISPOS.DE SOSTEN
19	★700121724		1 SUPPORT	SUPPORT SUPPORTO	LAGERUNG DISPOS.DE SOSTEN
20	700113992		2 GUIDE	GUIDE GUIDA	FUEHRUNG GUIA
21	700113991		2 ROD	TRINGLE ASTA	STANGE VARILLA
22	700714528		4 LATCH	VERROU CHIAVISTELLO	RIEGEL CERROJO
23	700113989P		2 ANGLE.	EQUERRE ANGOLO	WINKEL ANGULO
24	★70918451	1/8" X 3/4	6 PIN	GOUPILLE PERNO	BOLZEN PASADOR
25	★70921977	5/16"-18 X 1-1/4	1 CAPSCREW	VIS BOUCHON TAPPO A VITE	HUTSCHRAUBE TORNILLO TAPON
26	★700133624		2 DOOR	PORTIERE PORTA	TUER PUERTA

Shields
Garants
Schutzbleche
Difese
Proteccionee

60-50

Right Side - From 190lb-50101
Cote Droit - A Partir Du 190lb-50101
Rechte Seite - Ab 190lb-50101
Lado Sinistro - Dalla 190lb-50101
Lado Izquierdo - A Partir Del 190lb-50101

5-BA17-032-A

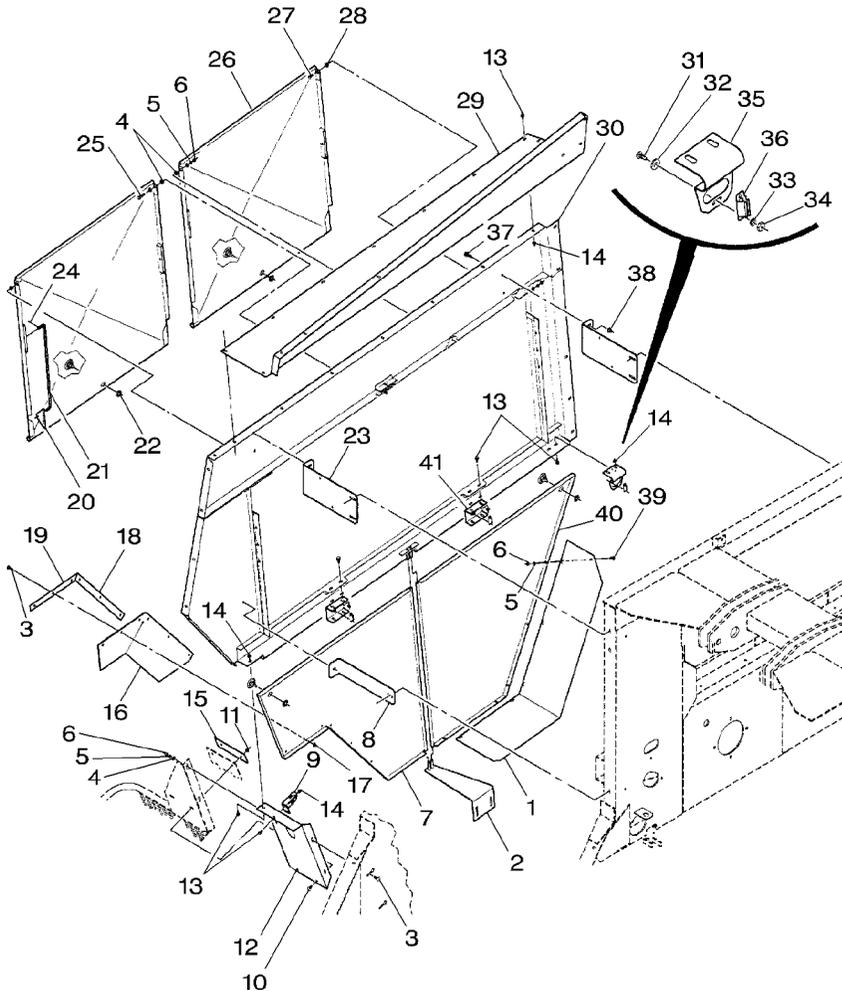

27	70921332	5/16"-18 X 3/4	2	CAPSCREW	VIS BOUCHON	HUTSCHRAUBE
28	6514772		4	SPACER	TAPPO A VITE	TORNILLO TAPON
29	700152205P		1	SHIELD	ENTRETOISE	ABSTANDSTUECK
30	700133621	➡ 190LB-50214	1	SHIELD	DISTANZIALE	DISCO ESPACIADOR
30	700152206P	➡ 190LB-50215	1	SHIELD	TOLE	SCHILD
31	700700628	No 10-24 X 1/2	8	SCREW	RIPARO	BLINDAJE
32	70917380	No 10	8	WASHER	TOLE	SCHILD
33	705004	No 10	8	LOCK WASHER	RIPARO	BLINDAJE
34	354120X1	No 10-24	8	NUT	TOLE	SCHILD
35	700133623		1	MOUNTING	RIPARO	BLINDAJE
36	700714529		4	RECEIVER	VIS	SCHRAUBE
37	7883382	3/8"-16 X 1	10	SCREW	VITE	TORNILLO
38	704247	3/8"-16	10	NUT	RONDELLE	UNTERLEGSCHIEBE
39	7700461	5/16"-18 X 3/4	5	BOLT	RONDELLA	ARANDELA
40	700133627P		1	SHIELD	RONDELLE FREIN	FEDERRING
41	700133106P		2	CHANNEL	ROSETTA DENTELL.	ARANDELA GROWER
					ECROU	MUTTER
					DADO	TUERCA
					MONTANT	HALTERUNG
					SUPPORTO MONTAGG	MONTANTE
					RECEVEUR	EMPFAENGER
					RICEVITORE	RECEPTOR
					VIS	SCHRAUBE
					VITE	TORNILLO
					ECROU	MUTTER
					DADO	TUERCA
					BOULON	MASCH.SCHRAUBE
					BULLONE	ESPIGA/BULON
					TOLE	SCHILD
					RIPARO	BLINDAJE
					CANAL	KANAL
					PROFILATO	CANAL

Shields
Garants
Schutzbleche
Difese
Proteccionee

60-55

Knotter - Up To 190lb-50100
Noueur - Jusqu'au 190lb-50100
Binder - Bis 190lb-50100
Legatore - Fino Alla 190lb-50100
Anudadora - Hasta 190lb-50100

5-BA17-013-A

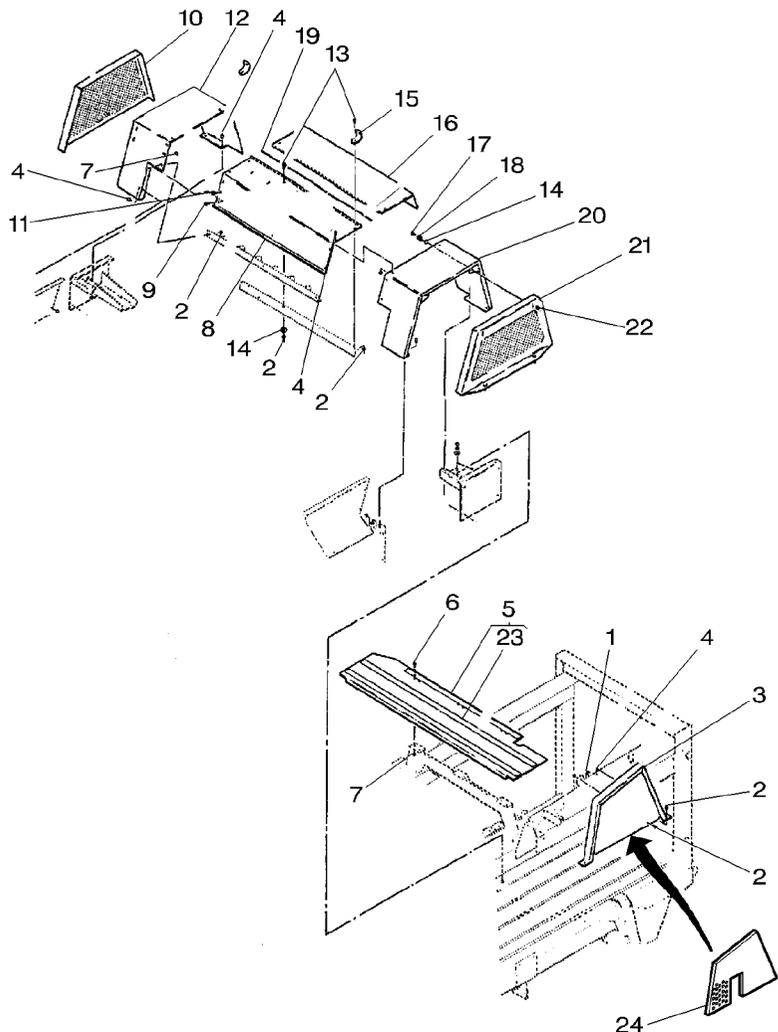

1	364534X1	5/16"-18 X 1	2	BOLT	BOULON	MASCH.SCHRAUBE
2	70931277	5/16"-18	24	NUT	BULLONE	ESPIGA/BULON
3	700114056M				ECROU	MUTTER
4	7883325	5/16"-18 X 3/4	15	SCREW	DADO	TUERCA
5	6564512		1	PLATFORM	TOLE	SCHILD
6	70922784	3/8"-16 X 3/4	6	BOLT	RIPARO	BLINDAJE
7	704247	3/8"-16	8	NUT	VIS	SCHRAUBE
8	700114054		1	SHIELD	VITE	TORNILLO
9	7883341	5/16"-18 X 1-1/4	1	PLATFORM	PLATEFORME	PLATTFORM
10	700114045	▶	1	CAP	PIATTAFORMA	PLATATORMA
11	7883382	3/8"-16 X 1	2	SCREW	BOULON	MASCH.SCHRAUBE
12	700114040	▶	1	FRAME	BULLONE	ESPIGA/BULON
13	7883333	5/16"-18 X 1	8	NUT	ECROU	MUTTER
14	390972X1	⊘ 8-17 X 1,7	1	SHIELD	DADO	TUERCA
15	6564595		3	SCREW	TOLE	SCHILD
16	700114055		1	SHIELD	RIPARO	BLINDAJE
17	7894975		1	SCREW	VIS	SCHRAUBE
18	7758212		1	CAP	VITE	TORNILLO
19	700122881		1	FRAME	CHAPEAU	KAPPE
20	700114039	◀	2	SCREW	CAPUCHON	TAPA
21	700114044	◀	1	FRAME	VIS	SCHRAUBE
22	7894967		1	FRAME	VITE	TORNILLO
23	6849178	5	10	WASHER METRIC	RONDELLE METR.	SCHEIBE METRISCH
24	3901323M91	[A]	2	STOP	RONDELLA METRICO	ARANDELA METRICO
			1	DOOR	BUTEE	ANSCHLAG
			8	CLIP	STOP	PARO
			8	SPRING	PORTIERE	TUER
			1	PIN	PORTA	PUERTA
			1	FRAME	CLIP	SHELLE
			8	HANDLE	FERMAGLIO	CLIP
			1	STRIP	RESSORT	FEDER
			1	GUARD	MOLLA	RESORTE
					GOUPILLE	BOLZEN
					PERNO	PASADOR
					BATI	RAHMEN
					CORNICE	BASTIDOR
					CHAPEAU	KAPPE
					CAPUCHON	TAPA
					POIGNEE	HANDGRIFF
					MANIGLIA	MANETA
					RUBAN	STREIFEN
					STRISCIA	TIRA
					GARDE	SCHUTZVORR
					PROTEZIONE	DEFENSA

Shields
Garants
Schutzbleche
Difese
Proteccionee

60-55

Knotter - Up To 190lb-50100
Noueur - Jusqu'au 190lb-50100
Binder - Bis 190lb-50100
Legatore - Fino Alla 190lb-50100
Anudadora - Hasta 190lb-50100

5-BA17-013-A

[A] EUROPE ONLY
EUROPE SEULEMENT
NUR FUER EUROPA
SOLO EUROPA
EUROPA SOLAMENTE

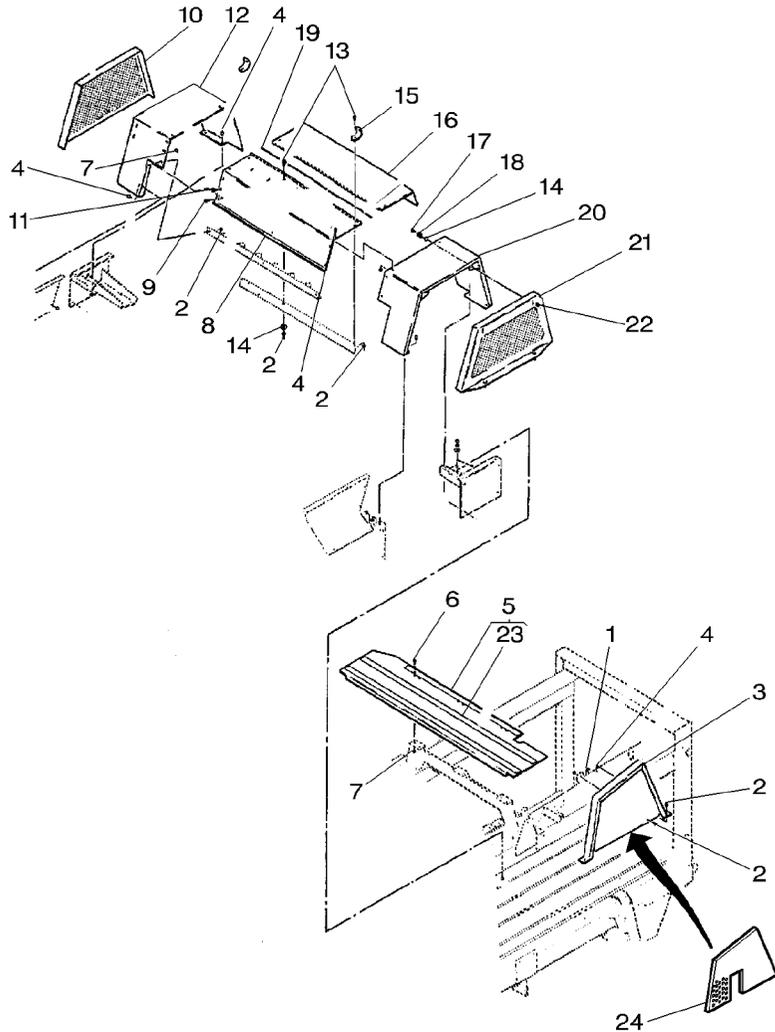

Shields
Garants
Schutzbleche
Difese
Proteccionee

60-60

Knotter - From 190lb-50101
Noueur - A Partir Du 190lb-50101
Binder - Ab 190lb-50101
Legatore - Dalla 190lb-50101
Anudadora - A Partir Del 190lb-50101

5-BA17-033-A

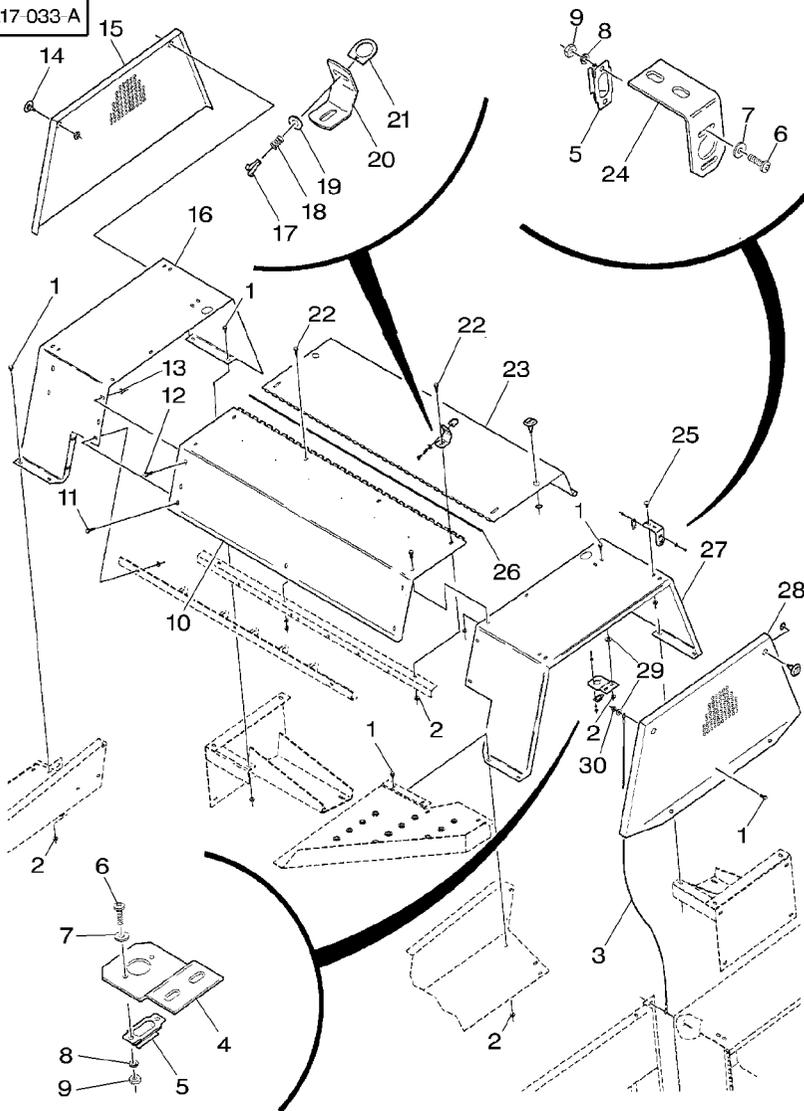

1	7883325	5/16"-18 X 3/4	21	SCREW	VIS	SCHRAUBE
2	70931277	5/16"-18	34	NUT	VITE	TORNILLO
3	8021693			ECROU	MUTTER	
4	700133160		2	CABLE	DADO	TUERCA
5	700714529			CABLE	CABLE	KABEL
6	700700628	No 10-24 X 1/2	2	SUPPORT	CAVO	CABLE
7	70917380	No 10	6	RECEIVER	SUPPORT	LAGERUNG
8	705004	No 10		SUPPORTO	SUPPORTO	DISPOS.DE SOSTEN
9	354120X1	No 10-24	12	SCREW	RECEVEUR	EMPFANGER
10	700133668			RICEVITORE	RECEPTOR	
11	7883341	5/16"-18 X 1-1/4	12	SCREW	VIS	SCHRAUBE
12	7883382	3/8"-16 X 1		VITE	TORNILLO	
13	704247	3/8"-16	12	WASHER	RONDELLE	UNTERLEGSCHIEBE
14	700714528			RONDELLA	ARANDELA	
15	700133662P		12	LOCK WASHER	RONDELLE FREIN	FEDERRING
16	700133666			ROSETTA DENTELL.	ARANDELA GROWER	
17	7894975		12	NUT	ECROU	MUTTER
18	7758212			DADO	TUERCA	
19	Y705525	5/16"	1	SHIELD	SCHILD	
20	6564595			TOLE	BLINDAJE	
21	7894967		3	SCREW	VIS	SCHRAUBE
22	7883333	5/16"-18 X 1		VITE	TORNILLO	
23	700133667	HM 91616	2	SCREW	VIS	SCHRAUBE
23	700139363M	HM 91617		VITE	TORNILLO	
24	700133664		2	NUT	ECROU	MUTTER
25	7700461	5/16"-18 X 3/4		DADO	TUERCA	
			6	LATCH	VERROU	RIEGEL
				CHIAVISTELLO	CERROJO	
			1	CAP	CHAPEAU	KAPPE
				FRAME	CAPUCHON	TAPA
				CLIP	BATI	RAHMEN
			2	CLIP	CORNICE	BASTIDOR
				SPRING	FERMAGLIO	SHELLE
				WASHER	RESSORT	CLIP
			2	SPRING	MOLLA	FEDER
				WASHER	RONDELLE	RESORTE
			4	WASHER	RONDELLE	UNTERLEGSCHIEBE
				STOP	RONDELLA	ARANDELA
			2	STOP	BUTEE	ANSCHLAG
				HANDLE	STOP	PARO
			2	HANDLE	POIGNEE	HANDGRIFF
				SCREW	MANIGLIA	MANETA
			4	SCREW	VIS	SCHRAUBE
				DOOR	VITE	TORNILLO
			1	DOOR	PORTIERE	TUER
				DOOR	PORTA	PUERTA
			1	DOOR	PORTIERE	TUER
				DOOR	PORTA	PUERTA
			4	SUPPORT	SUPPORT	LAGERUNG
				SUPPORT	SUPPORTO	DISPOS.DE SOSTEN
			8	BOLT	BOULON	MASCH.SCHRAUBE
				BOLT	BULLONE	ESPIGA/BULON

Shields
Garants
Schutzbleche
Difese
Proteccionee

60-60

Knotter - From 190lb-50101
Noueur - A Partir Du 190lb-50101
Binder - Ab 190lb-50101
Legatore - Dalla 190lb-50101
Anudadora - A Partir Del 190lb-50101

5-BA17-033-A

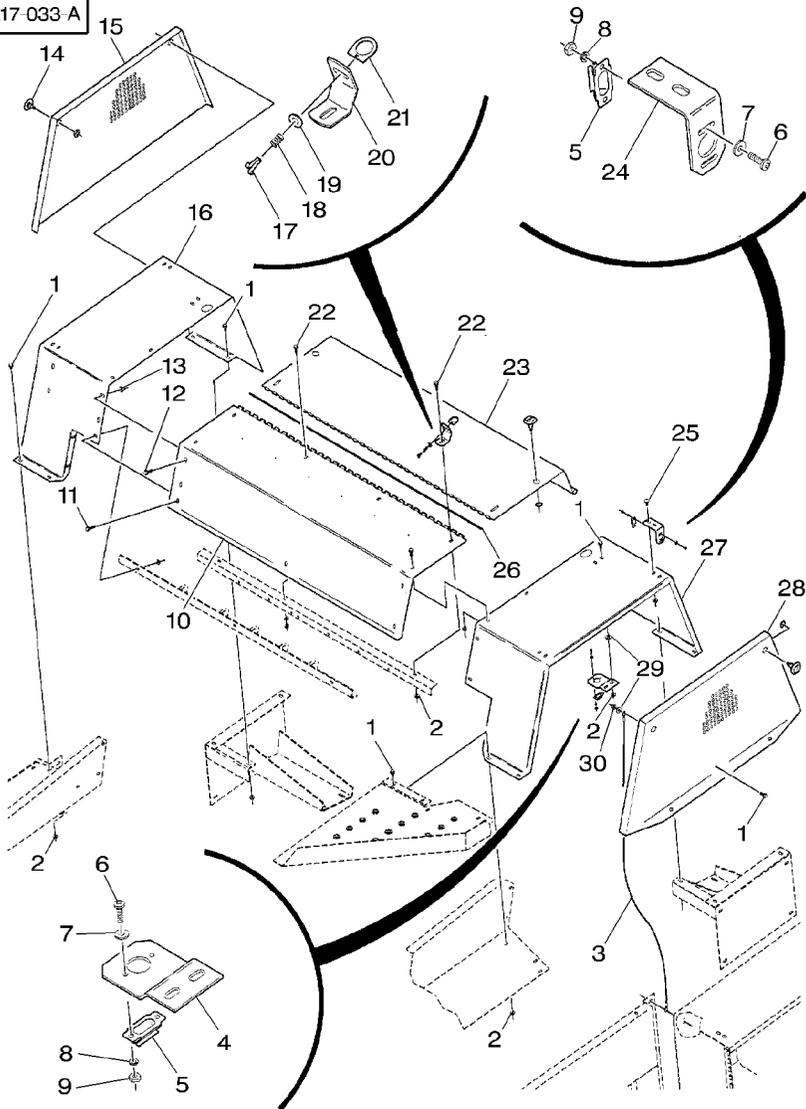

26 700122881

27 700133665

28★700133659

29★70917642

30 Y704726



5/16"

5/16"-18

1 PIN

1 FRAME

1 CAP

14 WASHER

2 LOCKNUT

GOUPILLE
PERNO
BATI
CORNICE
CHAPEAU
CAPUCHON
RONDELLE
RONDELLA
ECROU BLOCAGE
AUTOBLOCCANTE

BOLZEN
PASADOR
RAHMEN
BASTIDOR
KAPPE
TAPA
UNTERLEGSCHIEBE
ARANDELA
SICHERUNGSMUTTER
CONTRATUERCA

Twine Box
Boite A Ficelle
Garnbehälter
Scatola Portafilo
Caja De La Bobina

60-65

Guards - Left Side
Garants - Cote Gauche
Schutzvorr - Linke Seite
Protezione - Lato Sinistro
Defensa - Lado Izquierdo

5-BA42-025-A

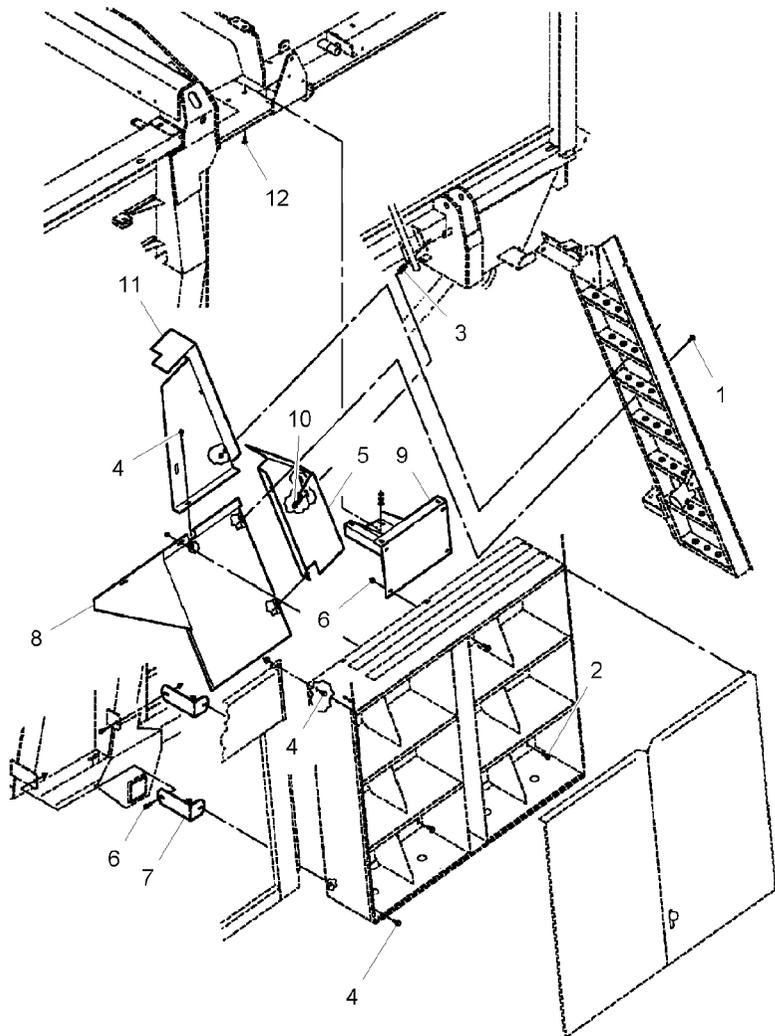

1	★7703432	3/8"-16 X 3/4	2	CAPSCREW	VIS BOUCHON	HUTSCHRAUBE
1	★704247	3/8"-16	2	NUT	TAPPO A VITE	TORNILLO TAPON
2	★7703424	3/8"-16 X 1	2	CAPSCREW	ECROU	MUTTER
2	★704247	3/8"-16	2	NUT	DADO	TUERCA
3	★Y705525	5/16"	20	WASHER	VIS BOUCHON	HUTSCHRAUBE
4	★7883325	5/16"-18 X 3/4	10	SCREW	TAPPO A VITE	TORNILLO TAPON
4	★70931277	5/16"-18	2	NUT	ECROU	MUTTER
5	★700133642P		20	WASHER	DADO	TUERCA
6	★7883382	3/8"-16 X 1	10	SCREW	RONDELLE	UNTERLEGSCHIEBE
6	★704247	3/8"-16	10	SCREW	RONDELLA	ARANDELA
7	★6844682P		10	NUT	VIS	SCHRAUBE
8	★700114048P		10	NUT	VITE	TORNILLO
9	★700114037P		10	NUT	ECROU	MUTTER
10	★7772056	5/16"-18 X 1-1/2	1	SHIELD	DADO	TUERCA
10	★70931277	5/16"-18	1	SHIELD	TOLE	SCHILD
11	★700133641		1	SHIELD	RIPARO	BLINDAJE
12	★70922786	3/8"-16 X 1	6	SCREW	SUPPORT FIXATION	SCHRAUBE
12	★Y705533	3/8"	6	NUT	STAFFETTA	SOPORTE
12	★70916965	3/8"	6	NUT	TOLE	SCHILD
12	★70916950	3/8"-16	2	BRACKET	RIPARO	BLINDAJE
			1	SHIELD	SUPPORT	LAGERUNG
			1	SUPPORT	SUPPORTO	DISPOS.DE SOSTEN
			2	SCREW	VIS	SCHRAUBE
			2	NUT	VITE	TORNILLO
			2	NUT	ECROU	MUTTER
			1	SHIELD	DADO	TUERCA
			1	SHIELD	TOLE	SCHILD
			2	BOLT	RIPARO	BLINDAJE
			2	WASHER	BOULON	MASCH.SCHRAUBE
			2	LOCK WASHER	BULLONE	ESPIGA/BULON
			2	NUT	RONDELLE	UNTERLEGSCHIEBE
			2	NUT	RONDELLA	ARANDELA
			2	NUT	RONDELLE FREIN	ARANDELA
			2	NUT	ROSETTA DENTELL.	GROWER
			2	NUT	ECROU	MUTTER
			2	NUT	DADO	TUERCA

Twine Box
Boite A Ficelle
Garnbehalter
Scatola Portafilo
Caja De La Bobina

60-70

Guards - Right Side
Garants - Cote Droit
Schutzvorr - Rechte Seite
Protezione - Lato Destro
Defensa - Lado Derecho

5 BA42 004 B

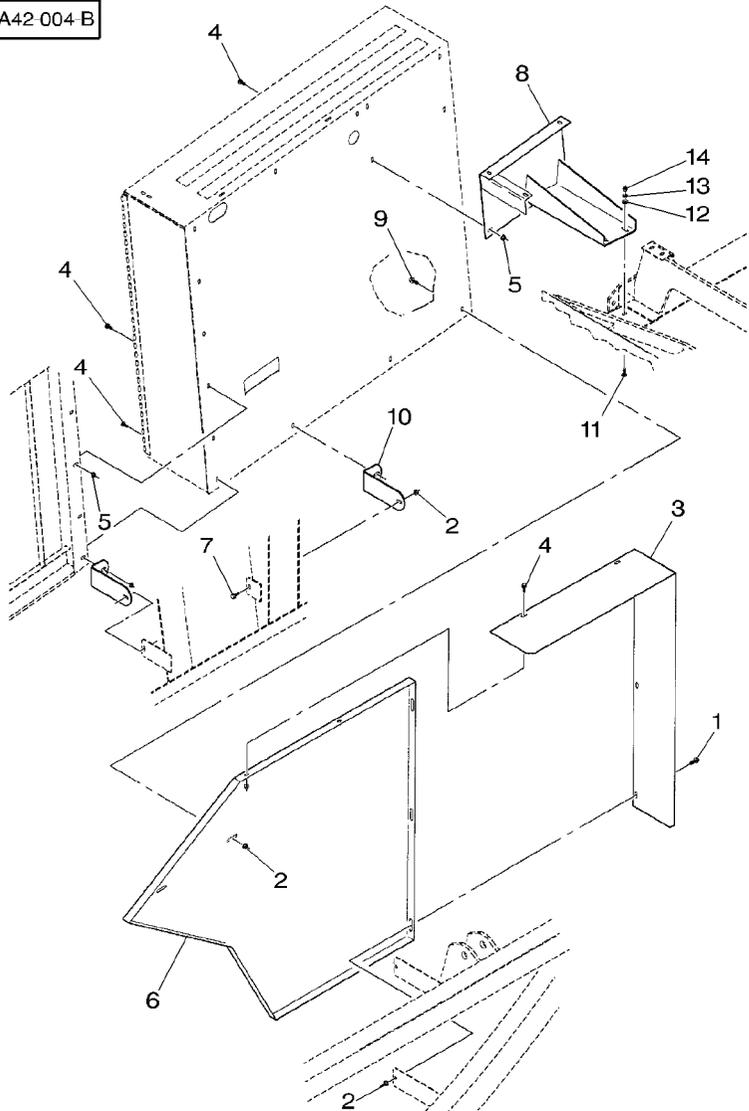

1	7883374	3/8"-16 X 3/4	3	SCREW	VIS	SCHRAUBE
2	704247	3/8"-16	7	NUT	VITE	TORNILLO
3	★700133713		1	SHIELD	ECROU	MUTTER
4	7883325	5/16"-18 X 3/4	13	SCREW	DADO	TUERCA
5	70931277	5/16"-18	13	NUT	TOLE	SCHILD
6	★700114049	➡ 190LB-50100	13	SHIELD	RIPARO	BLINDAJE
6	★700133712	➡ 190LB-50101	1	SHIELD	VIS	SCHRAUBE
7	7883382	3/8"-16 X 1	2	SCREW	DADO	TUERCA
8	700114038P	▶	1	SUPPORT	TOLE	SCHILD
9	7703424	3/8"-16 X 1	2	CAPSCREW	RIPARO	BLINDAJE
10	6844682P	◀	2	BRACKET	TOLE	SCHILD
11	70922786	3/8"-16 X 1	2	BOLT	RIPARO	BLINDAJE
12	Y705533	3/8"	2	WASHER	VIS	SCHRAUBE
13	★70916965	3/8"	2	LOCK WASHER	VITE	TORNILLO
14	★70916950	3/8"-16	2	NUT	SUPPORT	LAGERUNG
					SUPPORTO	DISPOS.DE SOSTEN
					VIS BOUCHON	HUTSCHRAUBE
					TAPPO A VITE	TORNILLO TAPON
					SUPPORT FIXATION	HALTEARM
					STAFFETTA	SOPORTE
					BOULON	MASCH.SCHRAUBE
					BULLONE	ESPIGA/BULON
					RONDELLE	UNTERLEGSCHIEBE
					RONDELLA	ARANDELA
					RONDELLE FREIN	FEDERRING
					ROSETTA DENTELL.	ARANDELA GROWER
					ECROU	MUTTER
					DADO	TUERCA

Twine Box
Boite A Ficelle
Garnbehalter
Scatola Portafilo
Caja De La Bobina

60-75

Left Side
Cote Gauche
Linke Seite
Lato Sinistro
Lado Izquierdo

5 BA42 003 B

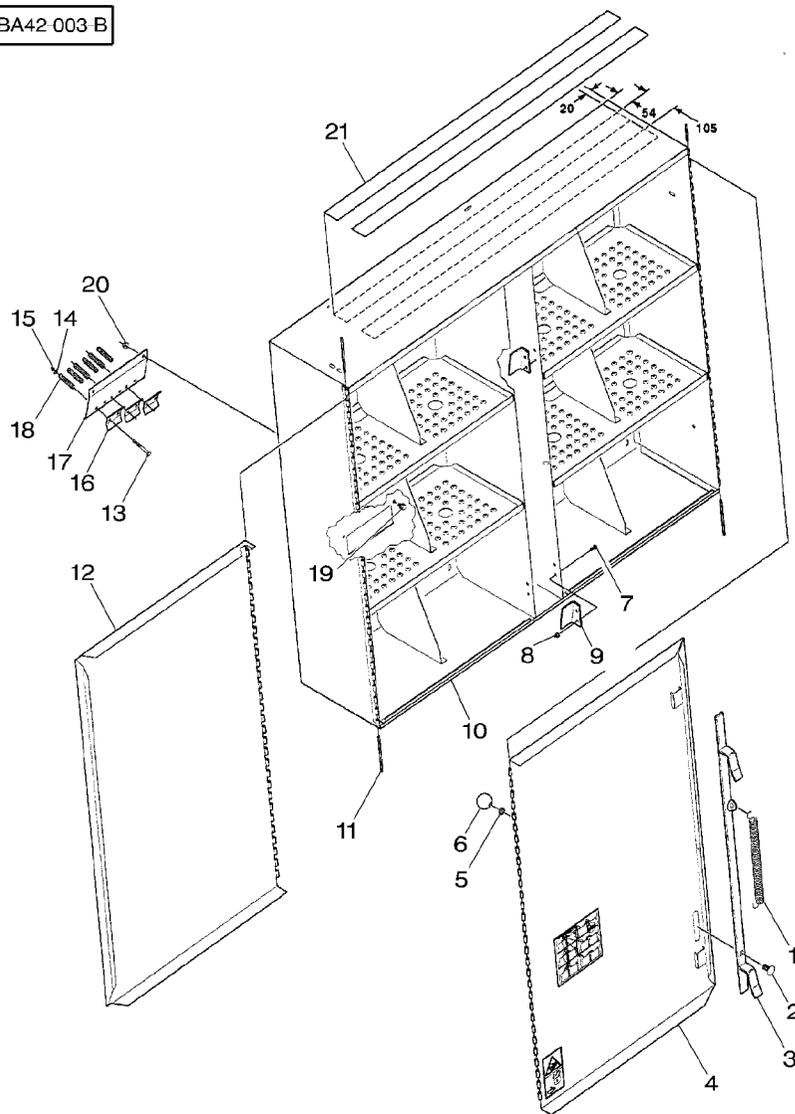

1	58941		1	SPRING	RESSORT	FEDER
2	70928367	1/2"-13 X 1	1	BOLT	MOLLA	RESORTE
3	6844633P		1	BUTTON	BOULON	MASCH.SCHRAUBE
4	700133654	[AC]	1	LATCH	BULLONE	ESPIGA/BULON
5	6270854		1	DOOR	VERROU	RIEGEL
6	720326		1	DOOR	CHIAVISTELLO	CERROJO
7	364941X1	1/4"-20 X 1/2	1	DOOR	PORTIERE	TUER
8	70931209	1/4"-20	1	DOOR	PORTA	PUERTA
9	6844674		1	SPACER	ENTRETOISE	ABSTANDSTUECK
10	700133650P		1	KNOB	DISTANZIALE	DISCO ESPACIADOR
11	700122881		1	KNOB	POMMEAU	KNOPF
12	6844625	[B]	1	KNOB	POMELO	POMO
13	7770225	1/4"-20 X 2-1/4	4	BOLT	BOULON	MASCH.SCHRAUBE
14	353769X1	1/4"	4	BOLT	BULLONE	ESPIGA/BULON
15	Y704395	1/4"-20	4	NUT	ECROU	MUTTER
16	6488431		2	CATCH	DADO	TUERCA
17	702400047		2	CATCH	LOQUET PORTE	FALLE
18	58925B	➡ 190LB-50100	1	BOX	ANCORAGGIO	FIJADOR
18	700707677B	➡ 190LB-50101	1	BOX	BOITE	DOSE
19	7771322	5/16"-18 X 1/2	2	PIN	SCATOLA	CAJA
20	70931277	5/16"-18	2	PIN	GOUPILLE	BOLZEN
21	6849178		1	DOOR	PERNO	PASADOR
			1	DOOR	PORTIERE	TUER
			1	DOOR	PORTA	PUERTA
			6	BOLT	BOULON	MASCH.SCHRAUBE
			6	WASHER	BULLONE	ESPIGA/BULON
			6	NUT	RONDELLE	UNTERLEGSCHIEBE
			3	CLIP	RONDELLA	ARANDELA
			1	PLATE	ECROU	MUTTER
			6	SPRING	DADO	TUERCA
			6	SPRING	CLIP	SHELLE
			2	SCREW	FERMAGLIO	CLIP
			2	NUT	PLAQUE	PLATTE
			1	STRIP	PIASTRA	PLATO
					RESSORT	FEDER
					MOLLA	RESORTE
					RESSORT	FEDER
					MOLLA	RESORTE
					VIS	SCHRAUBE
					VITE	TORNILLO
					ECROU	MUTTER
					DADO	TUERCA
					RUBAN	STREIFEN
					STRISCIA	TIRA

[A] WITH DECALS
AVEC DECALCOMANIES
MIT AUFKLEBER
CON DECALCOMANAS
CON CALCOMANIAS

Twine Box
Boite A Ficelle
Garnbehalter
Scatola Portafilo
Caja De La Bobina

60-75

Left Side
Cote Gauche
Linke Seite
Lato Sinistro
Lado Izquierdo

5 BA42 003 B

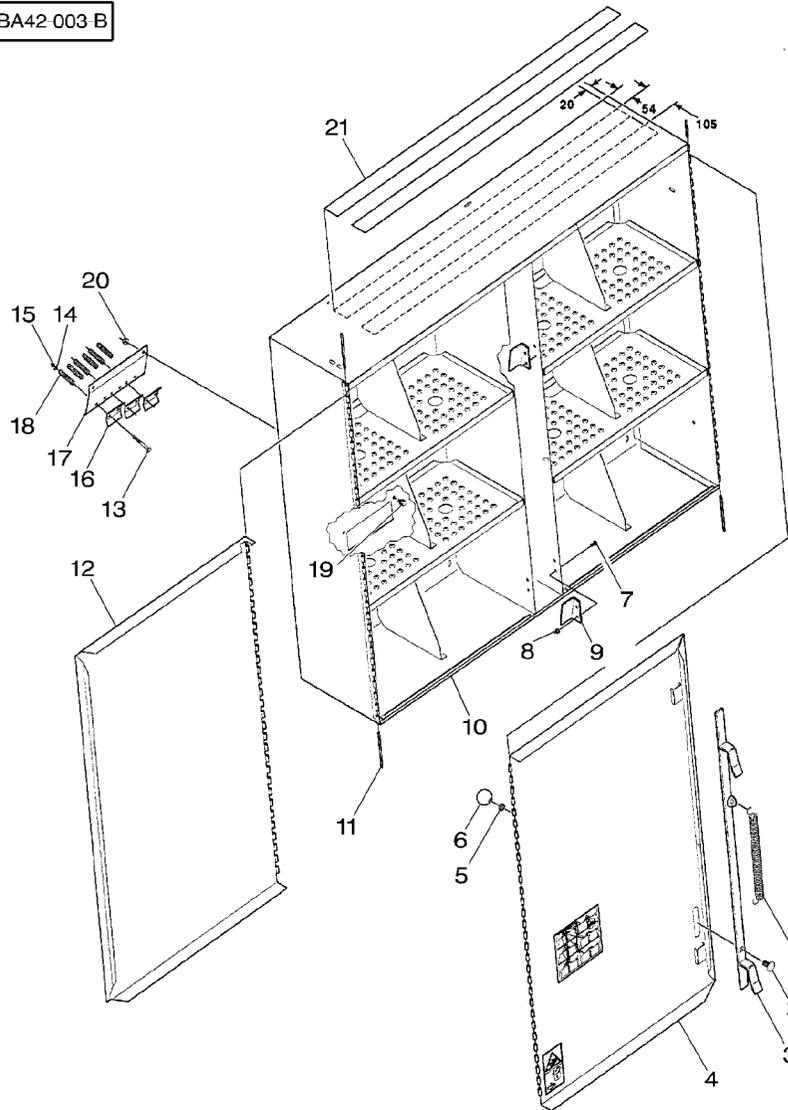

[B] FRONT
AVANT
VORN
ANTERIORE
DELANTERO

[C] REAR
ARRIERE
HINTEN
POSTERIORE
TRASERO

Twine Box
Boite A Ficelle
Garnbehälter
Scatola Portafilo
Caja De La Bobina

60-80

Right Side
Cote Droit
Rechte Seite
Lato Destro
Lado Derecho

5-BA42-013-B

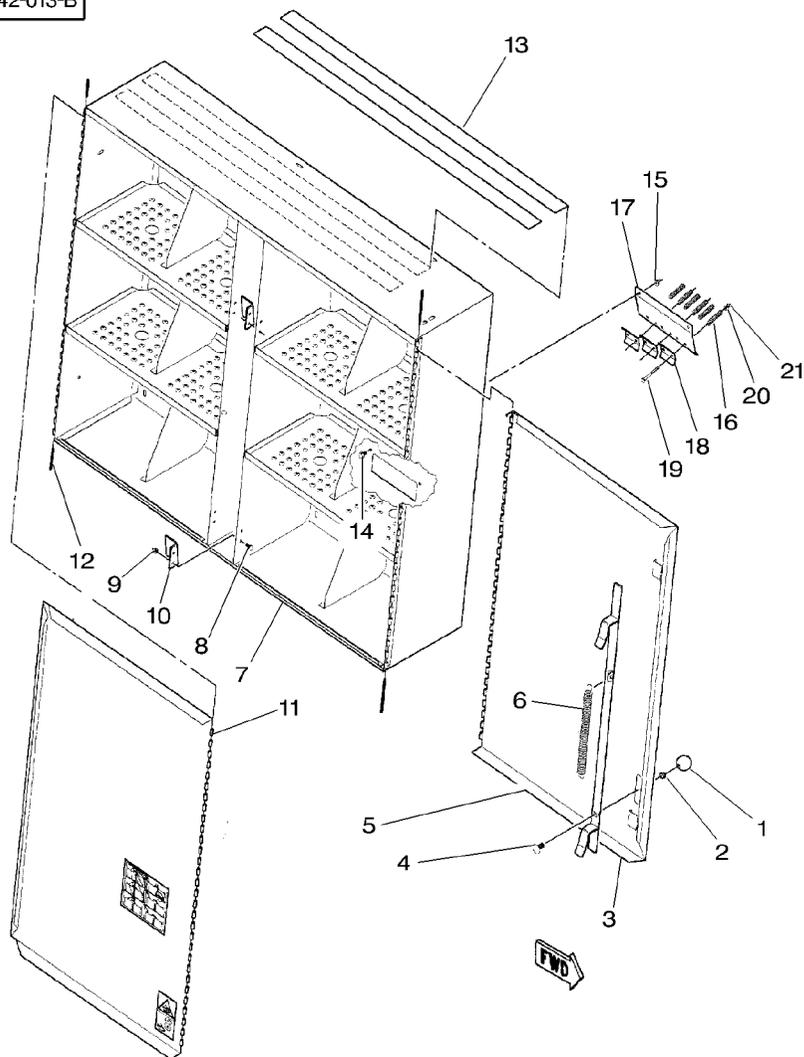

1	720326		1	KNOB	POMMEAU	KNOPF
2	6270854		1	SPACER	POMELO	POMO
3	6844633P		1	LATCH	ENTRETOISE	ABSTANDSTUECK
4	70928367	1/2"-13 X 1	1	BOLT	DISTANZIALE	DISCO ESPACIADOR
5	700133654	[B]	1	DOOR	VERROU	RIEGEL
6	58941	▲	1	SPRING	CHIAVISTELLO	CERROJO
7	700133653P		1	BOX	BOULON	MASCH.SCHRAUBE
8	364941X1	1/4"-20 X 1/2	4	BOLT	BULLONE	ESPIGA/BULON
9	70931209	1/4"-20	4	NUT	PORTIERE	TUER
10	6844674		2	CATCH	PORTA	PUERTA
11	700133655	[AC]	1	DOOR	RESSORT	FEDER
12	700122881	▲	1	SPRING	MOLLA	RESORTE
13	6849178		1	BOX	BOITE	DOSE
14	7771322	5/16"-18 X 1/2	4	BOLT	SCATOLA	CAJA
15	70931277	5/16"-18	4	NUT	BOULON	MASCH.SCHRAUBE
16	700707677B		4	NUT	BULLONE	ESPIGA/BULON
17	702400047		2	CATCH	ECROU	MUTTER
18	6488431		2	CATCH	DADO	TUERCA
19	7770225	1/4"-20 X 2-1/4	1	DOOR	LOQUET PORTE	FALLE
20	353769X1	1/4"	1	DOOR	ANCORAGGIO	FIJADOR
21	Y704395	1/4"-20	1	DOOR	PORTIERE	TUER
			2	PIN	PORTA	PUERTA
			1	STRIP	GOUPILLE	BOLZEN
			1	SCREW	PERNO	PASADOR
			2	SCREW	RUBAN	STREIFEN
			2	NUT	STRISCIA	TIRA
			6	SPRING	VIS	SCHRAUBE
			1	PLATE	VITE	TORNILLO
			3	CLIP	ECROU	MUTTER
			6	BOLT	DADO	TUERCA
			6	WASHER	RESSORT	FEDER
			6	NUT	MOLLA	RESORTE
					PLAQUE	PLATTE
					PIASTRA	PLATO
					CLIP	SHELLE
					FERMAGLIO	CLIP
					BOULON	MASCH.SCHRAUBE
					BULLONE	ESPIGA/BULON
					RONDELLE	UNTERLEGSCHIBE
					RONDELLA	ARANDELA
					ECROU	MUTTER
					DADO	TUERCA

[A] WITH DECALS
AVEC DECALCOMANIES
MIT AUFKLEBER
CON DECALCOMANAS
CON CALCOMANIAS

Twine Box
Boite A Ficelle
Garnbehälter
Scatola Portafilo
Caja De La Bobina

60-80

Right Side
Cote Droit
Rechte Seite
Lato Destro
Lado Derecho

5-BA42-013-B

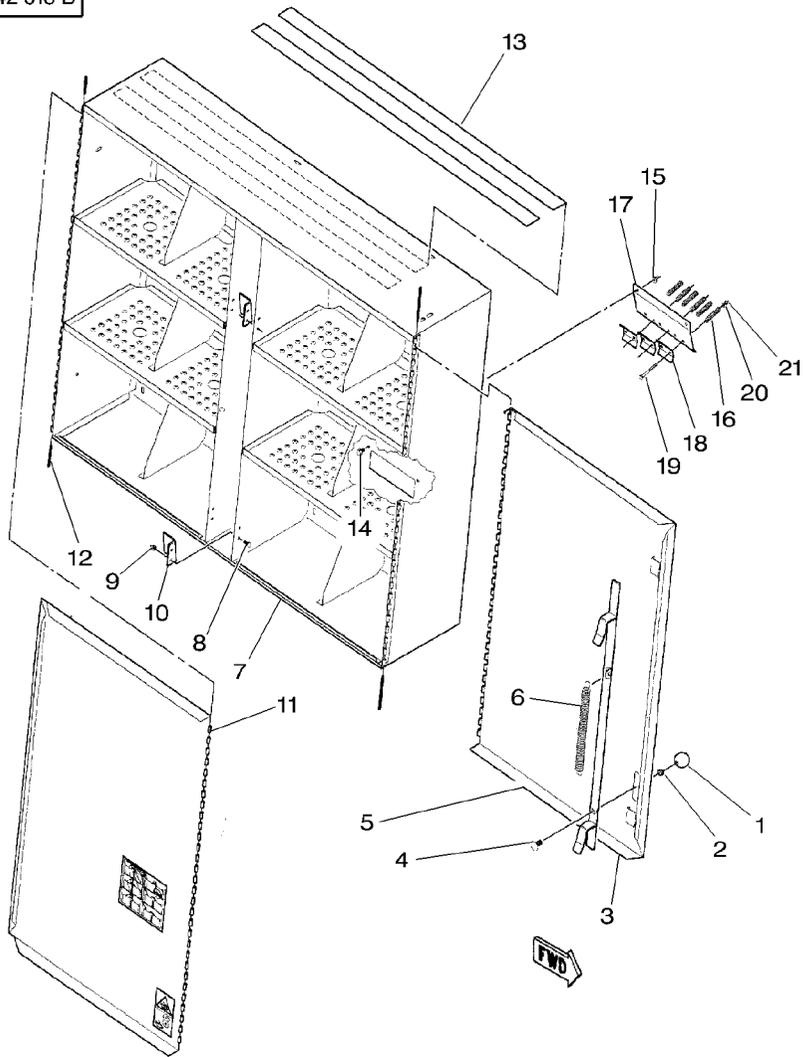

[B] FRONT
AVANT
VORN
ANTERIORE
DELANTERO

[C] REAR
ARRIERE
HINTEN
POSTERIORE
TRASERO

Ladder Rails
Echelle
Aufstieg
Guida Scala
Guia Escala

60-85

➔ 190LB-50214

5-BA52-003-A

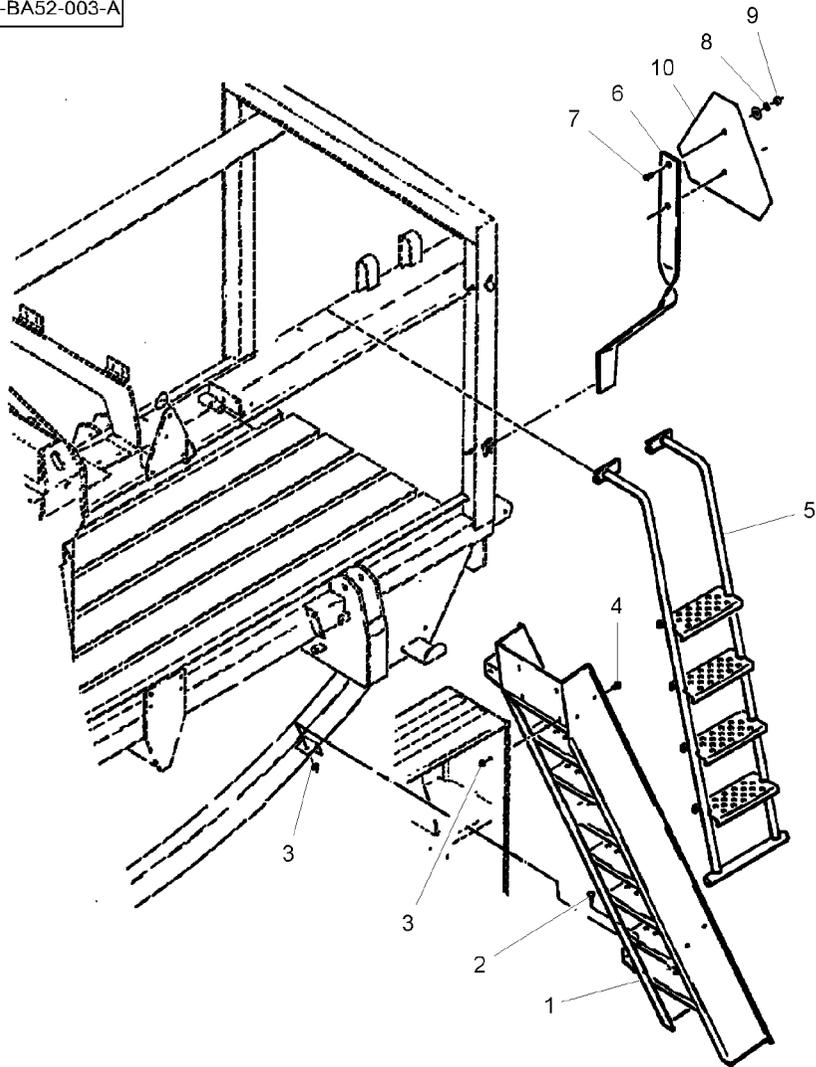

1	700114028	➔ 190LB-00...	1	LADDER	ECELLE	LEITER
1		👁 Undef Ref	1	LADDER	SCALA	ESCALERA
2	70922786	3/8-16 X 1	4	BOLT	ECELLE	LEITER
3	704247	3/8-16	8	NUT	SCALA	ESCALERA
4	7883374	3/8-16 X 3/4	4	SCREW	BOULON	MASCH.SCHRAUBE
5	700114060P	👁 60-120 No 1	1	LADDER	BULLONE	ESPIGA/BULON
6	6564645B		1	BRACKET	ECROU	MUTTER
7	700705088	No 10-24 X 3/4	2	SCREW	DADO	TUERCA
8	353445X1	No 10	2	LOCK WASHER	VIS	SCHRAUBE
9	354120X1	No 10-24	2	NUT	VITE	TORNILLO
10	71379434	➔ 19514A91	1	PLATE	ECELLE	LEITER
					SCALA	ESCALERA
					SUPPORT FIXATION	HALTEARM
					STAFFETTA	SOPORTE
					VIS	SCHRAUBE
					VITE	TORNILLO
					RONDELLE FREIN	FEDERRING
					ROSETTA DENTELL.	ARANDELA GROWER
					ECROU	MUTTER
					DADO	TUERCA
					PLAQUE	PLATTE
					PIASTRA	PLATO

Ladder Rails
Echelle
Aufstieg
Guida Scala
Guia Escala

60-90

From 190lb-50215 - Up To H.K 91220
A Partir Du 190lb-50215 - Jusqu'au H.K 91220
Ab Den 190lb-50215 - Bis H.K 91220
Dalla 190lb-50215 - Fino Alla H.K 91220
A Partir Del 190lb-50215 - Hasta H.K 91220

5-BA52-001-A

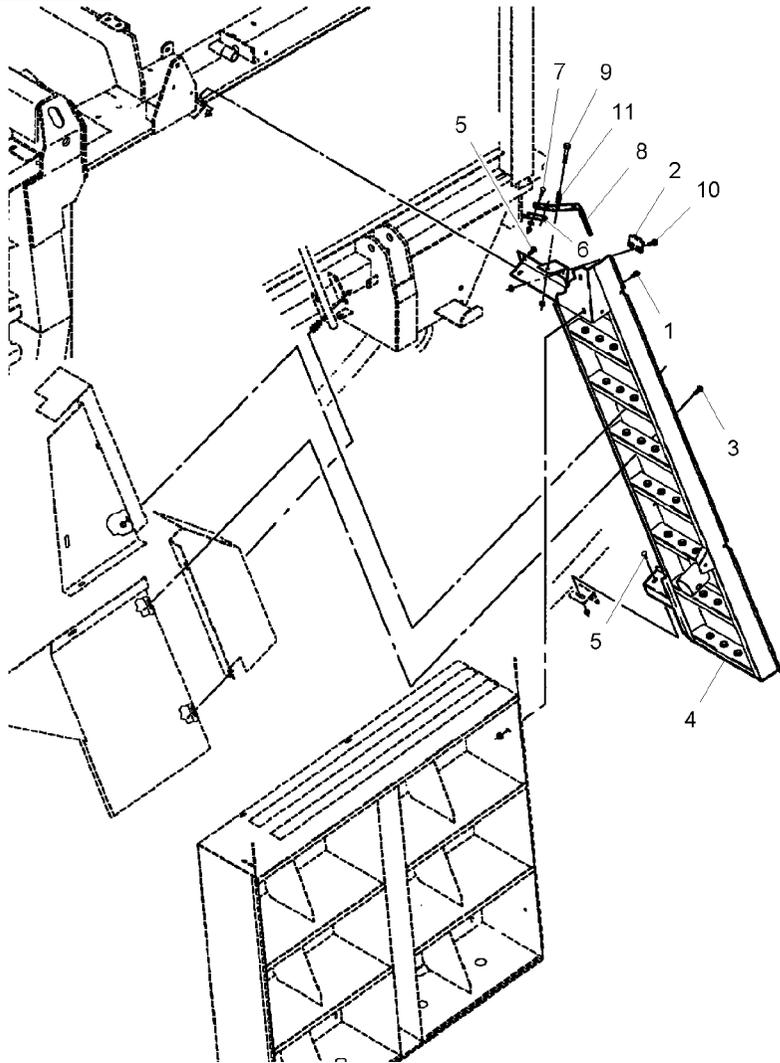

1	★7883374	3/8"-16 X 3/4	4	SCREW	VIS	SCHRAUBE
1	★704247	3/8"-16	4	NUT	VITE	TORNILLO
2	★700121606				ECROU	MUTTER
3	★7703432	3/8"-16 X 3/4	1	PLATE	DADO	TUERCA
3	★704247	3/8"-16	2	CAPSCREW	PLAQUE	PLATTE
4	★700133671				PIASTRA	PLATO
5	★70922786	3/8"-16 X 1	2	SCREW	VIS BOUCHON	HUTSCHRAUBE
5	★704247	3/8"-16	2	NUT	TAPPO A VITE	TORNILLO TAPON
6	★700151958				ECROU	MUTTER
7	★7700578	5/16"-18 X 1	1	LADDER	DADO	TUERCA
7	★Y705525	5/16"	1	LADDER	ECHELLE	LEITER
7	★70931277	5/16"-18	2	SCREW	SCALA	ESCALERA
8	★700151957				BOULON	MASCH.SCHRAUBE
9	★7702079	3/8"-16 X 2-1/2	4	BOLT	BULLONE	ESPIGA/BULON
9	★704247	3/8"-16	4	NUT	ECROU	MUTTER
10	★7883325	5/16"-18 X 3/4	1	STOP	DADO	TUERCA
10	★70931277	5/16"-18	2	SCREW	BUTEE	ANSCHLAG
11	★58644				STOP	PARO
					VIS	SCHRAUBE
					VITE	TORNILLO
					RONDELLE	UNTERLEGSSCHEIBE
					RONDELLA	ARANDELA
					ECROU	MUTTER
					DADO	TUERCA
					POIGNEE	HANDGRIFF
					MANIGLIA	MANETA
					VIS BOUCHON	HUTSCHRAUBE
					TAPPO A VITE	TORNILLO TAPON
					ECROU	MUTTER
					DADO	TUERCA
					VIS	SCHRAUBE
					VITE	TORNILLO
					ECROU	MUTTER
					DADO	TUERCA
					RESSORT	FEDER
					MOLLA	RESORTE

Ladder Rails
Echelle
Aufstieg
Guida Scala
Guia Escala

60-95

➔ HK 91221

5-BA52-002-A

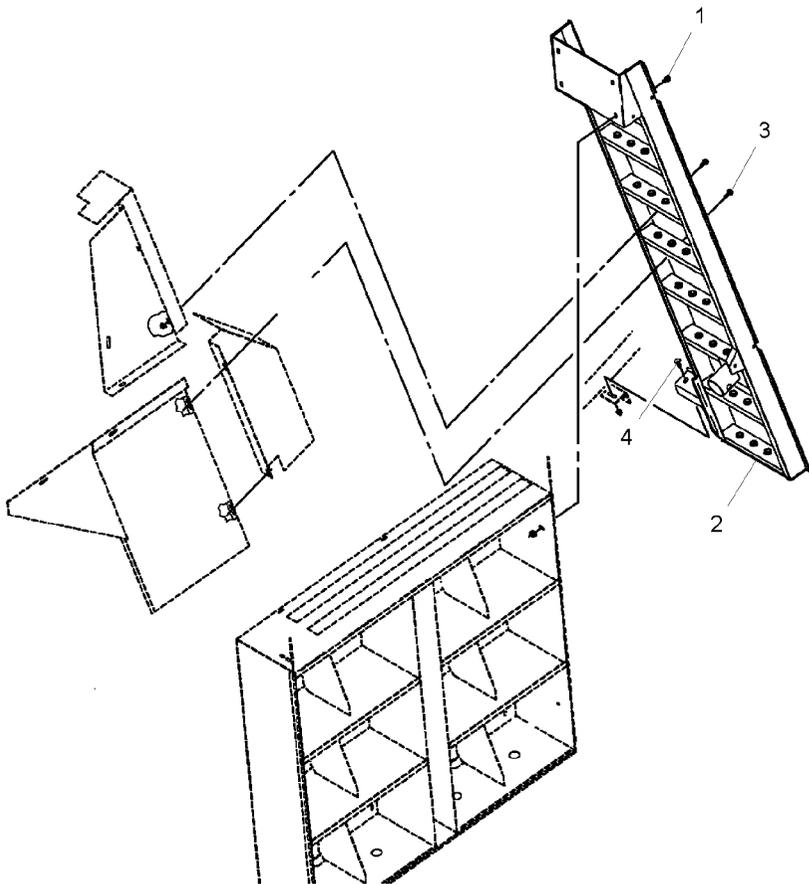

1 ★7883374	3/8"-16 X 3/4	4 SCREW	VIS VITE	SCHRAUBE TORNILLO
1 ★704247	3/8"-16	4 NUT	ECROU DADO	MUTTER TUERCA
2 ★700138825P		1 LADDER	ECHELLE SCALA	LEITER ESCALERA
3 ★7703432	3/8"-16 X 3/4	2 CAPSCREW	VIS BOUCHON TAPPO A VITE	HUTSCHRAUBE TORNILLO TAPON
3 ★704247	3/8"-16	2 NUT	ECROU DADO	MUTTER TUERCA
4 ★70922786	3/8"-16 X 1	4 BOLT	BOULON BULLONE	MASCH.SCHRAUBE ESPIGA/BULON
4 ★704247	3/8"-16	4 NUT	ECROU DADO	MUTTER TUERCA

Shields
Garants
Schutzbleche
Difese
Proteccionee

60-100

➔ 190LB-50100

5-BA17-017-A

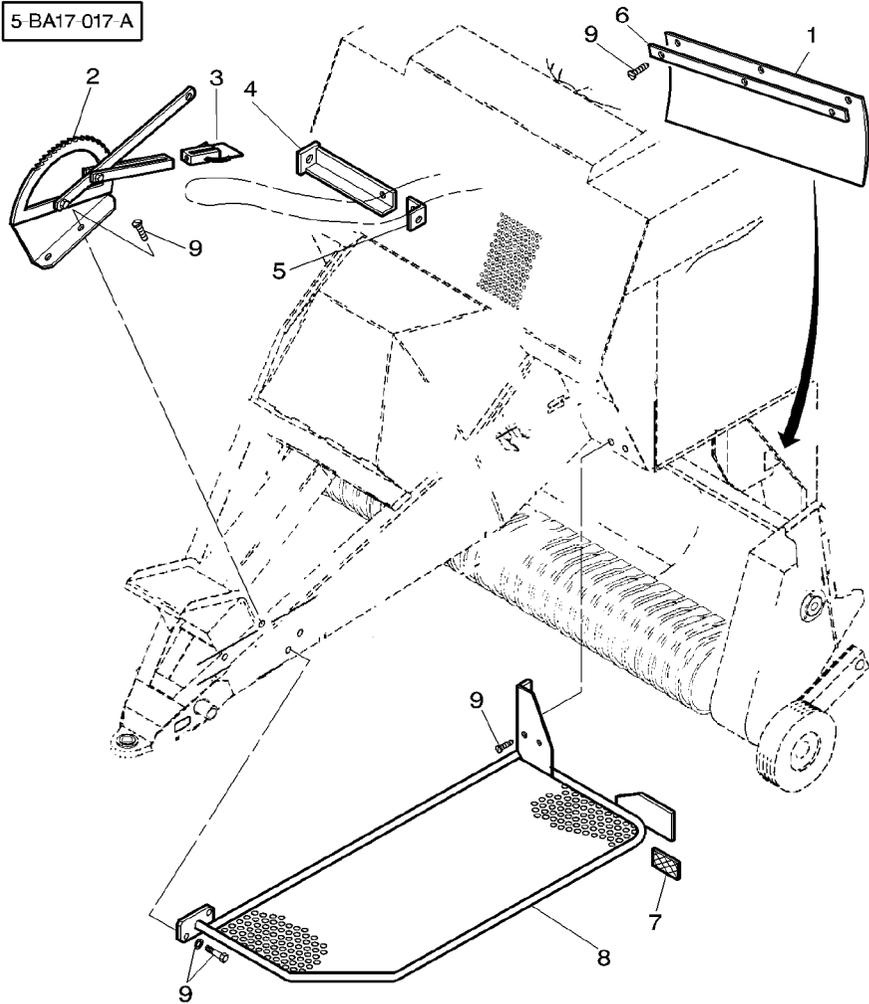

1	3901495M1	▶	1	GUARD	GARDE	SCHUTZVORR
1	3901496M1	◀	1	GUARD	PROTEZIONE	DEFENSA
2	3901284M91		1	HANDBRAKE ASSY	GARDE	SCHUTZVORR
3	3901286M91				PROTEZIONE	DEFENSA
4	3901289M1		1	LEVER	FREIN A MAIN	HANDBREMSE
5	3901288M1				FRENO A MANO	FRENO DE MANO
6			1	BRACKET	LEVIER	HEBEL
7	3901309M1				LEVA	PALANCA
8	3901324M91	◀	1	BRACKET	SUPPORT FIXATION	HALTEARM
8	3901322M91	▶			STAFFETTA	SOPORTE
9	353724X1		1	BRACKET	SUPPORT FIXATION	HALTEARM
9	369066X1				STAFFETTA	SOPORTE
9	353691X1		1	PLATE	STAFFETTA	SOPORTE
9	366573X1		2	REFLECTOR	PLAQUE	PLATTE
9	353756X1				PIASTRA	PLATO
9	353669X1		2	GUARD	CATADIOPTRE	REFLEKTOR
9	360256X1				OJO DE GATO	CATADIOPTRICO
9	390735X1		1	GUARD	GARDE	SCHUTZVORR
9	353754X1		1	GUARD	PROTEZIONE	DEFENSA
			4	BOLT UNC	GARDE	SCHUTZVORR
					PROTEZIONE	DEFENSA
			4	NUT	BOULON UNC	MASCH.SCHRB.UNC
					BULLONE UNC	PERNO UNC
			4	WASHER	ECROU	MUTTER
					DADO	TUERCA
			6	BOLT UNC	BOULON UNC	MASCH.SCHRB.UNC
					BULLONE UNC	PERNO UNC
			6	LOCKNUT	ECROU BLOCAGE	SICHERUNGSMUTTER
					AUTOBLOCCANTE	CONTRATUERCA
			12	WASHER	RONDELLE	UNTERLEGSCHIBE
					RONDELLA	ARANDELA
			9	BOLT UNC	BOULON UNC	MASCH.SCHRB.UNC
					BULLONE UNC	PERNO UNC
			9	LOCKNUT	ECROU BLOCAGE	SICHERUNGSMUTTER
					AUTOBLOCCANTE	CONTRATUERCA
			8	WASHER	RONDELLE	UNTERLEGSCHIBE
					RONDELLA	ARANDELA
			18	WASHER	RONDELLE	UNTERLEGSCHIBE
					RONDELLA	ARANDELA

Shields
Garants
Schutzbleche
Difese
Proteccionee

60-105

➔ 190LB-50101

5-BA17-035-A

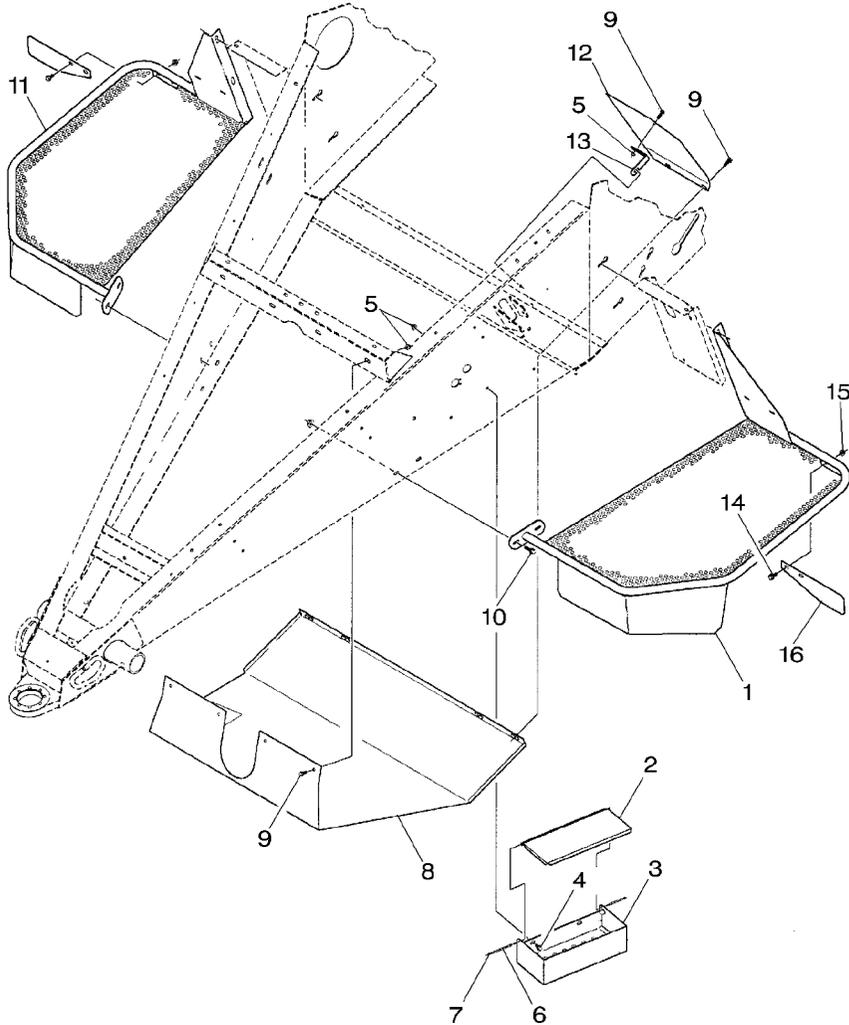

1	700133726	◀	1	SHIELD	TOLE	SCHILD
2	700108569P		1	LID	RIPARO	BLINDAJE
3	700108566P		1	BOX	PLAQUE COUVERCLE	ABDECKPLATTE
4	7703432	3/8"-16 X 3/4	2	CAPSCREW	COPERTA	COBERTURA
5	704247	3/8"-16	11	NUT	BOITE	DOSE
6	700108570		1	ROD	SCATOLA	CAJA
7	700707858		2	RETAINER	VIS BOUCHON	HUTSCHRAUBE
8	★700139376		1	SHIELD	TAPPO A VITE	TORNILLO TAPON
9	7883382	3/8"-16 X 1			ECROU	MUTTER
10	★7773104	3/8"-16 X 1-1/2	1	SHIELD	DADO	TUERCA
11	700133729	▶	1	SHIELD	TRINGLE	STANGE
12	700114023P		2	RETAINER	ASTA	VARILLA
13	700114024		1	SHIELD	RETENEUR	HALTERING
14	7883374	3/8"-16 X 3/4	1	SHIELD	FERMO	RETENEDOR
15	Y704734	3/8"-16	9	SCREW	TOLE	SCHILD
16	★700133724		4	SCREW	RIPARO	BLINDAJE
			1	SHIELD	VIS	SCHRAUBE
			4	SCREW	VITE	TORNILLO
			1	SHIELD	VIS	SCHRAUBE
			1	SHIELD	VITE	TORNILLO
			1	ANGLE.	TOLE	SCHILD
			4	SCREW	RIPARO	BLINDAJE
			4	LOCKNUT	TOLE	SCHILD
			2	SUPPORT	RIPARO	BLINDAJE
					EQUERRE	WINKEL
					ANGOLO	ANGULO
					VIS	SCHRAUBE
					VITE	TORNILLO
					ECROU BLOCAGE	SICHERUNGSMUTTER
					AUTOBLOCCANTE	CONTRATUERCA
					SUPPORT	LAGERUNG
					SUPPORTO	DISPOS.DE SOSTEN

Shields
Garants
Schutzbleche
Difese
Proteccionee

60-110

Tubular Support Stays – Up To 190lb-50100
Armature – Jusqu’Au 190lb-50100
Armatur – Bis 190lb-50100
Armatura – Fino Alla 190lb-50100
Armadura – Hasta 190lb-50100

5-BA17-014-A

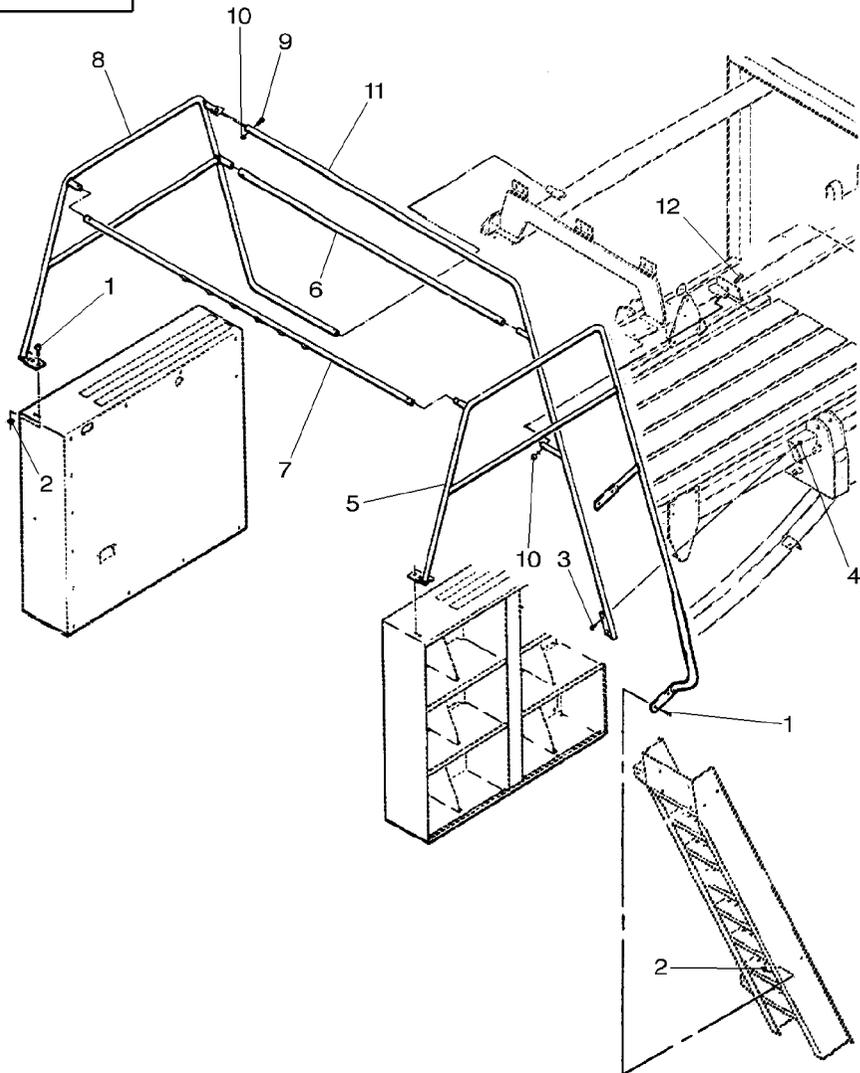

1	7703432	3/8"-16 X 3/4	8	CAPSCREW	VIS BOUCHON	HUTSCHRAUBE
2	704247	3/8"-16	8	NUT	TAPPO A VITE	TORNILLO TAPON
3	7772049	5/16"-18 X 1	2	CAPSCREW	ECROU	MUTTER
4	70931277	5/16"-18	2	NUT	DADO	TUERCA
5	6564702	▶	1	RAIL	VIS BOUCHON	HUTSCHRAUBE
6	6564827		1	CROSS LINK	TAPPO A VITE	TORNILLO TAPON
7	6564819		1	CROSS LINK	ECROU	MUTTER
8	6564769	▶	1	RAIL	DADO	TUERCA
9	70926150	5/16"-18 X 1-1/2	5	CAPSCREW	RAIL	SCHIENE
10	Y704163	5/16"-18	1	CROSS LINK	SBARRA	RIEL
11	6564785B	▶	1	RAIL	BARRE TRANSVERS	ZAPFENKREUZ
12	353687X1	5/16"-18 X 2	2	BOLT UNC	MAGLIA TRASVERS.	ENGANCHE TRANSV
					BARRE TRANSVERS	ZAPFENKREUZ
					MAGLIA TRASVERS.	ENGANCHE TRANSV
					RAIL	SCHIENE
					SBARRA	RIEL
					VIS BOUCHON	HUTSCHRAUBE
					TAPPO A VITE	TORNILLO TAPON
					ECROU	MUTTER
					DADO	TUERCA
					RAIL	SCHIENE
					SBARRA	RIEL
					BOULON UNC	MASCH.SCHRB.UNC
					BULLONE UNC	PERNO UNC

Shields
Garants
Schutzbleche
Difese
Proteccionee

60-115

Tubular Support Stays – From 190lb-50101
Armature – A Partir Du 190lb-50101
Armaturo – Ab 190lb-50101
Armatura – Dalla 190lb-50101
Armadura – A Partir Del 190lb-50101

5-BA17-030-B

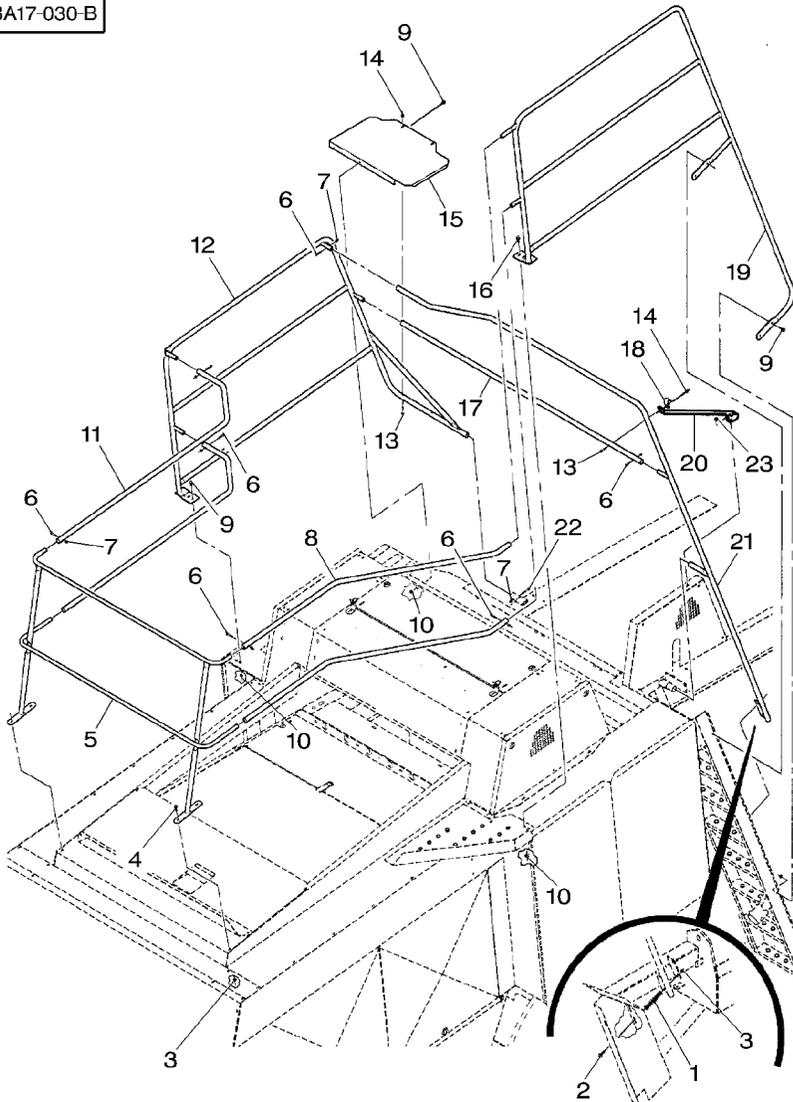

1	★70917642	5/16"	20	WASHER	RONDELLE	UNTERLEGSSCHEIBE
2	7772056	5/16"-18 X 1-1/2	2	SCREW	RONDELLA	ARANDELA
3	70931277	5/16"-18	6	NUT	VIS	SCHRAUBE
4	7883325	5/16"-18 X 3/4	4	SCREW	VITE	TORNILLO
5	★700133691B		1	SHIELD	ECROU	MUTTER
6	★70921221	5/16"-18 X 1-1/2	10	CAPSCREW	DADO	TUERCA
7	Y704163	5/16"-18	12	NUT	VITE	SCHRAUBE
8	700133690	◀	2	RAIL	TOLE	TORNILLO
9	7703432	3/8"-16 X 3/4	8	CAPSCREW	RIPARO	SCHILD
10	704247	3/8"-16	10	NUT	VIS BOUCHON	BLINDAJE
11	★700133696	▶	2	RAIL	TAPPO A VITE	HUTSCHRAUBE
12	700133697	▶	1	RAIL	ECROU	TORNILLO TAPON
13	★70922127	5/16"-18 X 1-3/4	2	RAIL	DADO	MUTTER
14	Y704726	5/16"-18	1	RAIL	RAIL	TUERCA
15	★700133705		1	PANEL	SBARRA	SCHIENE
16	7703424	3/8"-16 X 1	1	RAIL	SBARRA	RIEL
17	★700133704B		3	CAPSCREW	RAIL	RIEL
18	70926917		1	BAR	SBARRA	RIEL
19	700133685	◀	1	CLAMP	VIS BOUCHON	HUTSCHRAUBE
20	★700152226		3	LOCKNUT	TAPPO A VITE	TORNILLO TAPON
21	700133706	▶	1	PANEL	ECROU BLOCAGE	SICHERUNGSMUTTER
22	★70921978	5/16"-18 X 2	2	CAPSCREW	AUTOBLOCCANTE	CONTRATUERCA
23	7883333	5/16"-18 X 1	1	SCREW	PANNEAU	VERKL.BLECH
			1	ANGLE.	PANNELLO	PANELAJE
			1	BAR	VIS BOUCHON	HUTSCHRAUBE
			1	CLAMP	TAPPO A VITE	TORNILLO TAPON
			1	RAIL	BARRE	STAB
			1	RAIL	BARRA	BARRA
			1	RAIL	COLLIER	HALTESCHELLE
			1	RAIL	FASCETTA	ABRAZADERA
			1	RAIL	RAIL	SCHIENE
			1	RAIL	SBARRA	RIEL
			1	RAIL	EQUERRE	WINKEL
			1	RAIL	ANGOLO	ANGULO
			1	RAIL	RAIL	SCHIENE
			1	RAIL	SBARRA	RIEL
			2	CAPSCREW	VIS BOUCHON	HUTSCHRAUBE
			1	SCREW	TAPPO A VITE	TORNILLO TAPON
					VIS	SCHRAUBE
					VITE	TORNILLO

Shields
Garants
Schutzbleche
Difese
Proteccionee

60-120

5-BA17-036-A

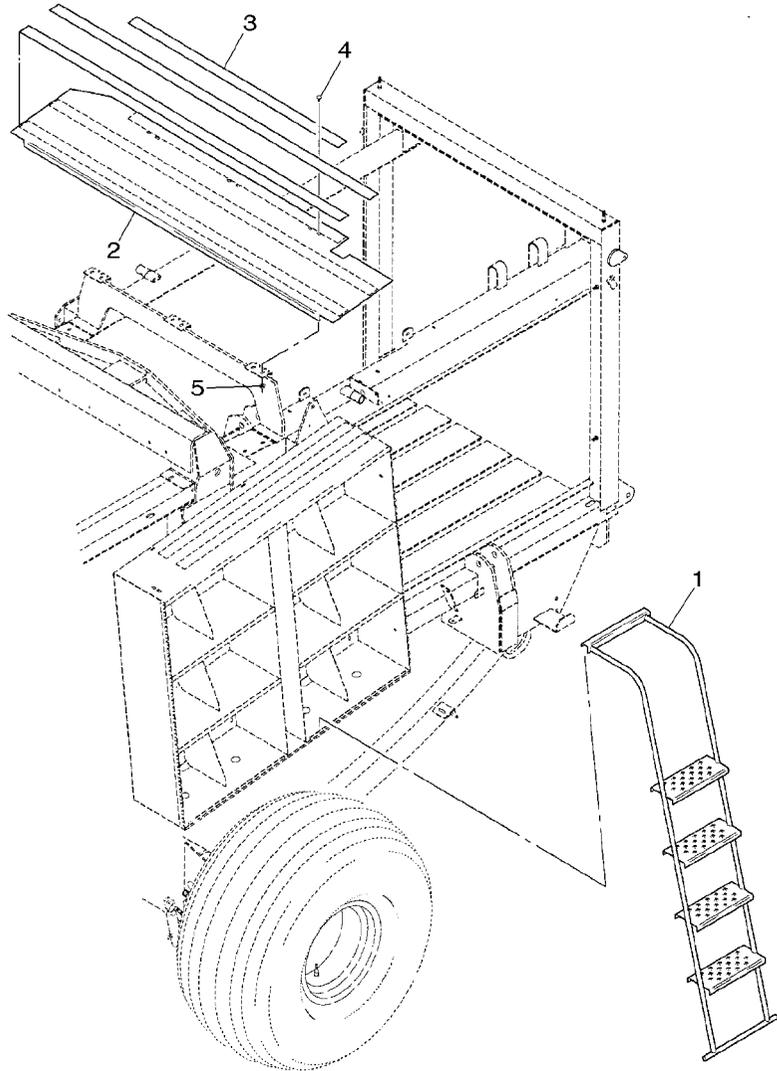

1	700114060P		1	LADDER	EHELLE	LEITER
2	6564512		1	PLATFORM	SCALA	ESCALERA
3	6849178		1	STRIP	PLATEFORME	PLATTFORM
4	70922784	3/8"-16 X 3/4	6	BOLT	PIATTAFORMA	PLATATORMA
5	704247	3/8"-16	6	NUT	RUBAN	STREIFEN
					STRISCIA	TIRA
					BOULON	MASCH.SCHRAUBE
					BULLONE	ESPIGA/BULON
					ECROU	MUTTER
					DADO	TUERCA

Shields
Garants
Schutzbleche
Difese
Proteccionee

60-125

➔ 190LB-50146

5-BA17-016-B

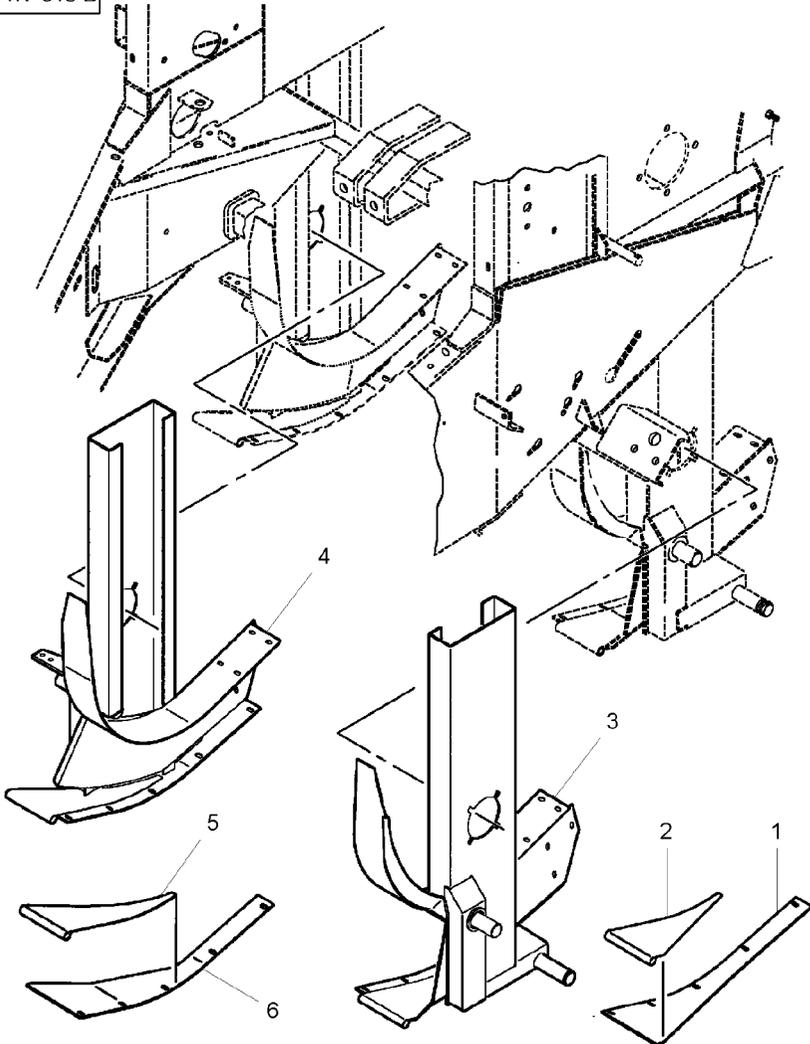

- 1 700113538
- 2 700113540
- 3 700113532
- 4 700113533
- 5 700113541
- 6 700113539

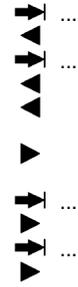

- 1 SUPPORT
- 1 PANEL
- 1 STRUT
- 1 STRUT
- 1 PANEL
- 1 SUPPORT

SUPPORT
SUPPORTO
PANNEAU
PANNELLO
JAMBE DE FORCE
PUNTORE
JAMBE DE FORCE
PUNTORE
PANNEAU
PANNELLO
SUPPORT
SUPPORTO

LAGERUNG
DISPOS.DE SOSTEN
VERKL.BLECH
PANELAJE
VERSTREBUNG
CODAL
VERSTREBUNG
CODAL
VERKL.BLECH
PANELAJE
LAGERUNG
DISPOS.DE SOSTEN

Shields
Garants
Schutzbleche
Difese
Proteccionee

60-130

➔ 190LB-50147

5-BA17-103-A

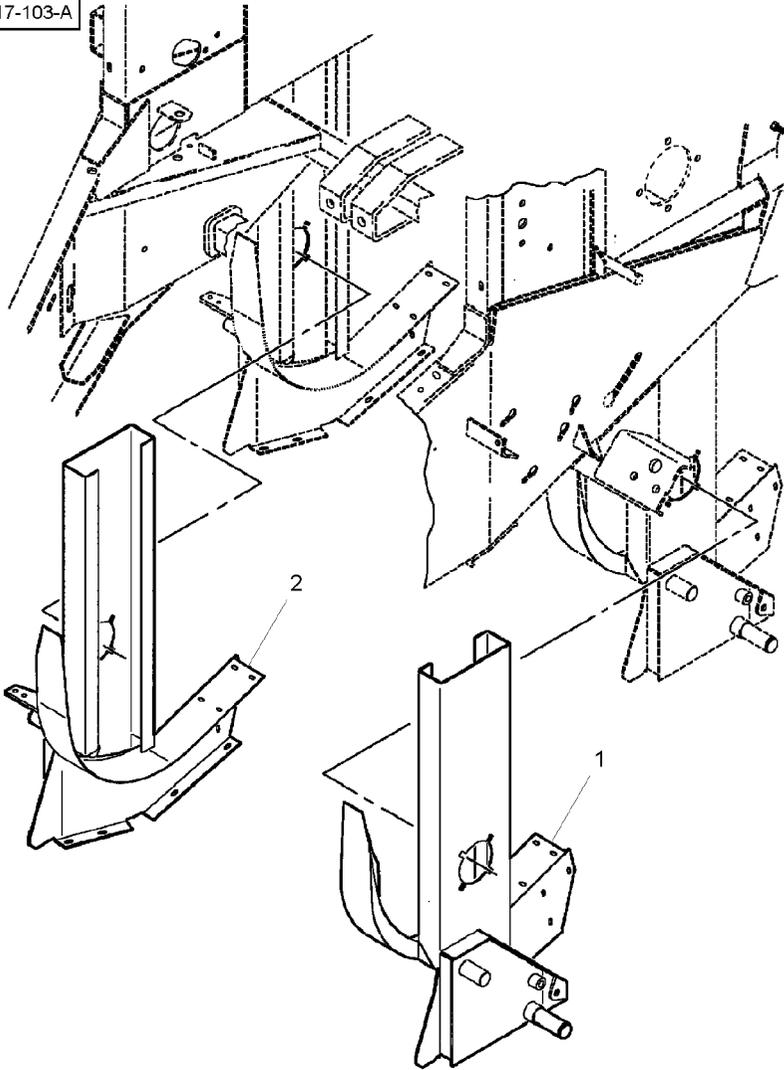

1 ★ 700150598



1 STRUT

JAMBE DE FORCE
PUNTONE

VERSTREBUNG
CODAL

2 ★ 700134953



1 STRUT

JAMBE DE FORCE
PUNTONE

VERSTREBUNG
CODAL

Brake System
 Systeme De Freinage
 Brems System
 Sisteia Di Frenata
 Sistema De Frenado

60-135

5-BA13-007-C

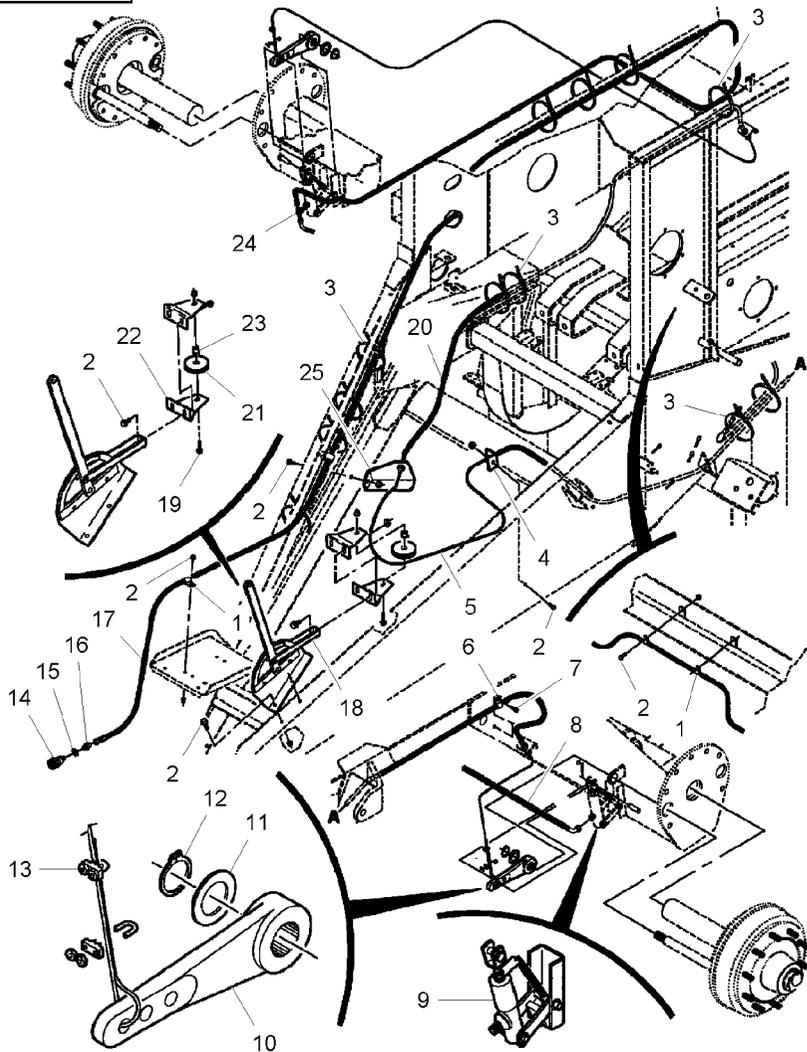

1★70926049	3/4"	3	CLAMP	COLLIER	HALTESCHELLE
2★7883382	3/8"-16 X 1	9	SCREW	FASCETTA	ABRAZADERA
2★Y704734	3/8"-16	9	LOCKNUT	VITE	SCHRAUBE
3★70925094		9	LOCKNUT	ECROU BLOCAGE	TORNILLO
4★700133076		12	TIE	AUTOBLOCCANTE	SICHERUNGSMUTTER
5★700714993	➔ 190LB-50214	1	SUPPORT	ATTACHE	CONTRATUERCA
5★700724838	➔ 190LB-50215	1	CABLE	TRAVERSA ATTACCO	BARRA DE ENLACE
6 70930708		1	SUPPORT	SUPPORT	LAGERUNG
7 701953		1	CABLE	SUPPORTO	DISPOS.DE SOSTEN
8★700715228		1	HANDBRAKE CABLE	CABLE	KABEL
9★700714990	➔ 190LB-50186	1	CLAMP	CAVO	CABLE
9 700716972	👁 60-140 No 1	1	CLAMP	CAVO FRENO MANO	HANDBREMSEKABEL
10★700715230	➔ 190LB-50187	1	SCREW	COLLIER	CABLE FRENO MANO
11★700715959	👁 60-140 No 1	1	HOSE	FASCETTA	HALTESCHELLE
12★700715958		1	SCREW	VITE	ABRAZADERA
13★700714994		1	HOSE	SCHLAUCH	SCHRAUBE
14★700720423		1	HOSE	DURITE	TORNILLO
15★700720414		2	BRAKE CYLINDER	TUBO FLESSIBILE	SCHLAUCH
16★700720416		2	BRAKE CYLINDER	CYLINDRE FREIN	FLEXIBLE
17★700715004		2	LEVER	CYLINDRO FRENO	BREMSZYLINDER
18★700716814		2	LEVER	CYLINDRO FRENO	BREMSZYLINDER
19★7883341	5/16"-18 X 1-1/4	2	LEVER	CILINDRO FRENO	CILINDRO FRENO
19★Y704726	5/16"-18	2	WASHER	LEVIER	HEBEL
20★700715204	➔ 190LB-50214	2	WASHER	LEVA	PALANCA
20★700724837	➔ 190LB-50215	2	RING	RONDELLE	UNTERLEGSSCHEIBE
21★700120328		2	RING	RONDELLA	ARANDELA
		2	RING	ANNEAU	RING
		4	CLAMP	ANELLO	ARO
		1	COUPLER	COLLIER	HALTESCHELLE
		1	WASHER	FASCETTA	ABRAZADERA
		1	ADAPTOR	ACCOPPIEMENT	KUPPLUNGSTUECK
		1	ADAPTOR	ACCOPIATORE	ACOPLADOR
		1	HOSE	RONDELLE	UNTERLEGSSCHEIBE
		1	LEVER	RONDELLA	ARANDELA
		1	SCREW	ADAPTATEUR	REDUZIERNIPPEL
		1	SCREW	ADATTATORE	ADAPTADOR
		1	SCREW	DURITE	SCHLAUCH
		1	SCREW	TUBO FLESSIBILE	FLEXIBLE
		1	SCREW	LEVIER	HEBEL
		1	SCREW	LEVA	PALANCA
		1	SCREW	VITE	SCHRAUBE
		1	SCREW	ECROU BLOCAGE	TORNILLO
		1	SCREW	AUTOBLOCCANTE	SICHERUNGSMUTTER
		2	HANDBRAKE CABLE	ATTACHE	CONTRATUERCA
		2	HANDBRAKE CABLE	TRAVERSA ATTACCO	BARRA DE ENLACE
		2	HANDBRAKE CABLE	SUPPORT	LAGERUNG
		2	HANDBRAKE CABLE	SUPPORTO	DISPOS.DE SOSTEN
		1	PULLEY	CABLE	KABEL
		1	PULLEY	CAVO	CABLE
		1	PULLEY	CAVO FRENO MANO	HANDBREMSEKABEL
		1	PULLEY	CAVO FRENO MANO	CABLE FRENO MANO
		1	PULLEY	CAVO FRENO MANO	HANDBREMSEKABEL
		1	PULLEY	CAVO FRENO MANO	CABLE FRENO MANO
		1	PULLEY	POULIE	RIEMENSCHLEIFE
		1	PULLEY	PULEGGIA	POLEA

Brake System
 Systeme De Freinage
 Brems System
 Sistea Di Frenata
 Sistema De Frenado

60-135

5-BA13-007-C

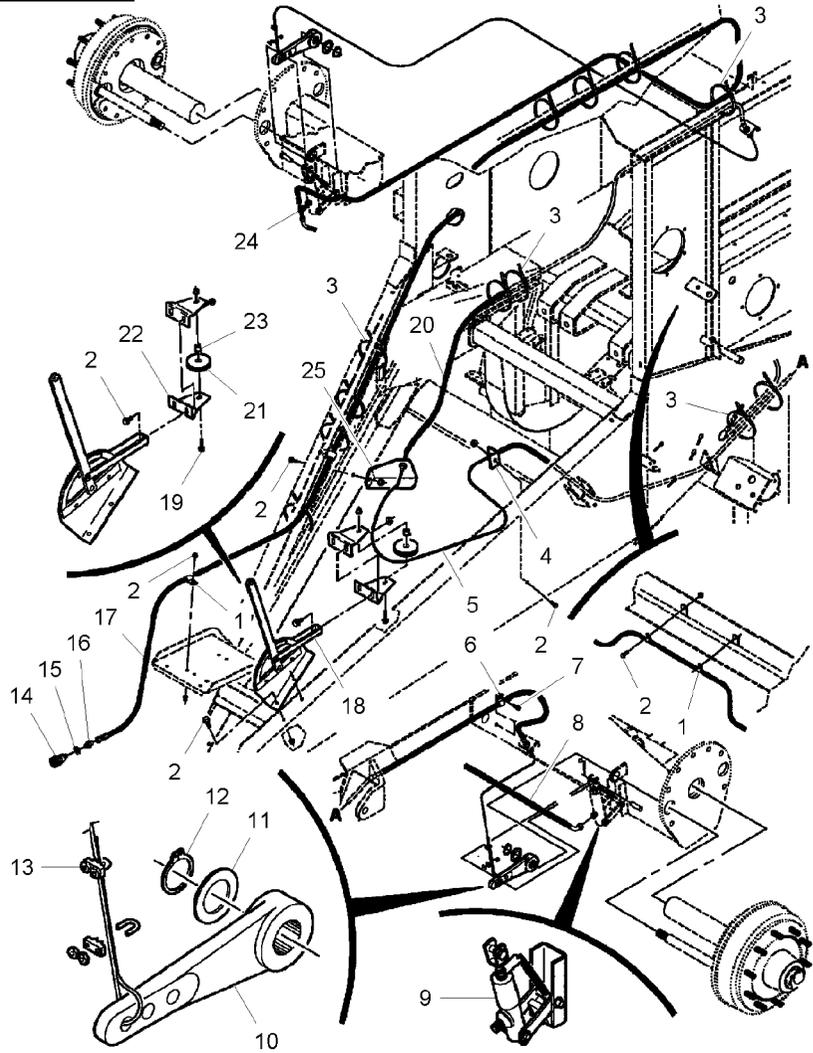

- 22★700133077
- 23★700119414
- 24★700715006
- 25★700149700P

- 2 SUPPORT
- 1 BUSH
- 1 TEEPIECE
- 1 SUPPORT

SUPPORT
 SUPPORTO
 BAGUE
 BOCCOLA
 TE
 RACCORDO A T
 SUPPORT
 SUPPORTO

LAGERUNG
 DISPOS.DE SOSTEN
 BUCHSE
 CASQUILLO
 T-STUECK
 PIEZA EN T
 LAGERUNG
 DISPOS.DE SOSTEN

Brake System
 Systeme De Freinage
 Brems System
 Sisteas Di Frenata
 Sistema De Frenado

60-140

5-BA13-004-B

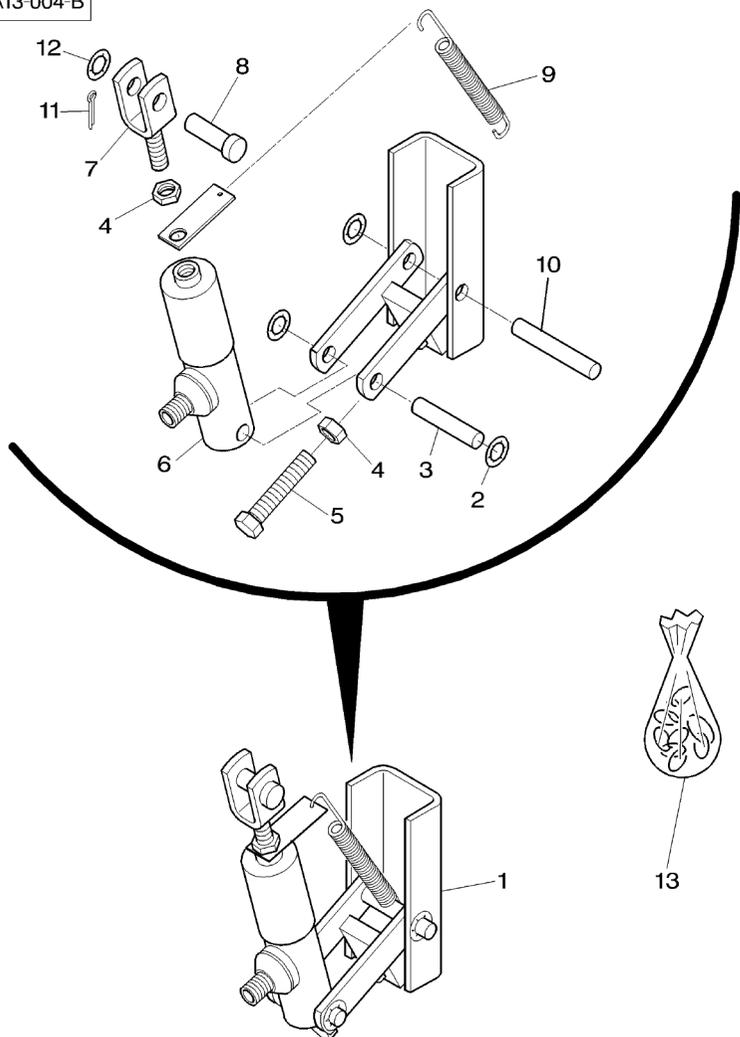

1	★700714990	➡	190LB-50186	1	BRAKE CYLINDER	CYLINDRE FREIN	BREMSZYLINDER
1	700716972	➡	190LB-50187	1	BRAKE CYLINDER	CILINDRO FRENO	CILINDRO FRENO
2	★700716807			4	CLIP	CYLINDRE FREIN	BREMSZYLINDER
3	★700716810			1	SHAFT	CILINDRO FRENO	CILINDRO FRENO
4	7704000		1 1/2"-20	2	NUT	CLIP	SCHELLE
5	700716806		1 1/2"-20 X 2-1/2	1	SCREW	FERMAGLIO	CLIP
6	★		1	➡	REF. 1	ARBRE	WELLE
7	★700716812			1	CLEVIS	ALBERO	ARBOL
8	★700716808			1	CLEVIS PIN	ECROU	MUTTER
9	★700716805			1	SPRING	DADO	TUERCA
10	★700716809			1	SHAFT	VIS	SCHRAUBE
11	354059X1		1	➡	...	VITE	TORNILLO
12	70927727		1	➡	...	VERIN	HYDR.ZYLINDER
13	★700716813		➡	190LB-50186	1	CILINDRO IDRAUL.	ARIETE
13	★700716973		➡	190LB-50187	1	CHAPE	GABELSTUECK
						GANCIO D'ATTACCO	GANCHO SEGUR.
						AXE	SPLINTBOLZEN
						PERNO D'ATTACCO	BULON CILINDRICO
						RESSORT	FEDER
						MOLLA	RESORTE
						ARBRE	WELLE
						ALBERO	ARBOL
						GOUPILLE FENDUE	SPALTBOLZEN
						COPIGLIA	PASADOR HENDIDO
						SEGMENT ARRET	SPRENGRING
						ANELLO SIEGER	ANILLA RETENCION
						JOINT ETANCHEITE	DICHTRING
						ANELLO RACCORD	ARENDELA D'JUNTA
						JOINT ETANCHEITE	DICHTRING
						ANELLO RACCORD	ARENDELA D'JUNTA

Brake System
 Systeme De Freinage
 Brems System
 Sisteia Di Frenata
 Sistema De Frenado

60-145

5-BA13-002-D

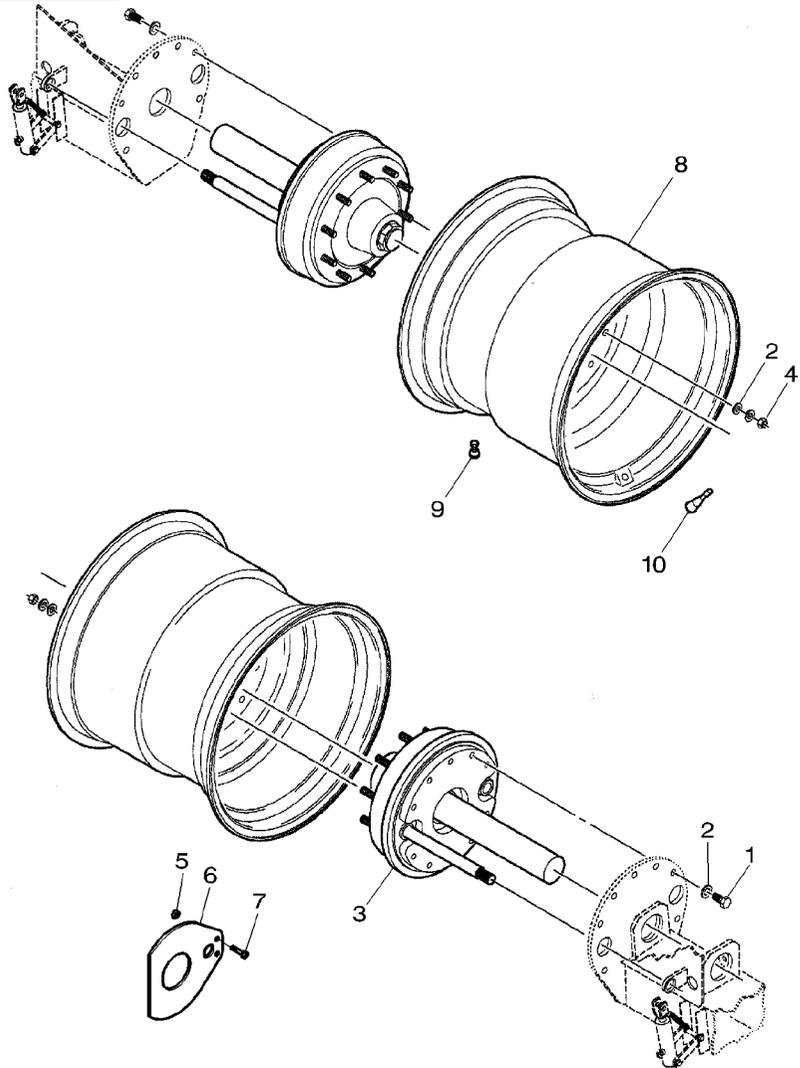

1	70923110	3/4"-10 X 1-1/2	14	CAPSCREW	VIS BOUCHON	HUTSCHRAUBE
2	Y705566	3/4"	54	WASHER	TAPPO A VITE	TORNILLO TAPON
3	3901319M91	➔ 190LB-50100	2	HUB	RONDELLE	UNTERLEGSCHIEBE
3	700133745P	➔ 190LB-50101	2	AXLE	RONDELLA	ARANDELA
4	3384597M1	➔ 190LB-50100	10	NUT	MOYEU	NABE
4	700715684	➔ 190LB-50101	10	NUT	MOZZO	CUBO
5	373575X1	➔ 190LB-50100	4	LOCKNUT	ESSIEU	ACHSE
6	3901320M91	➔ 190LB-50100	1	BRACKET	ASSALE	EJE
7	361078X1	➔ 190LB-50100	4	BOLT UNC	ECROU	MUTTER
8	700714441	DWH 25 X 26	2	WHEEL	DADO	TUERCA
9	7027477		2	PLUG	ECROU	MUTTER
10	7027469		2	PRESSURE VALVE	DADO	TUERCA
					ECROU BLOCAGE	SICHERUNGSMUTTER
					AUTOBLOCCANTE	CONTRATUERCA
					SUPPORT FIXATION	HALTEAM
					STAFFETTA	SOPORTE
					BOULON UNC	MASCH.SCHRB.UNC
					BULLONE UNC	PERNO UNC
					ROUE	RAD
					RUOTA	RUEDA
					BOUCHON	VERSCHL.STOPFEN
					TAPPO	TAPON
					VALVE	DRUCKVENTIL
					VALVOLA PRESSION	VALVULA PRESSION

Brake System
 Systeme De Freinage
 Brems System
 Sisteia Di Frenata
 Sistema De Frenado

60-150

5-BA13-005-B

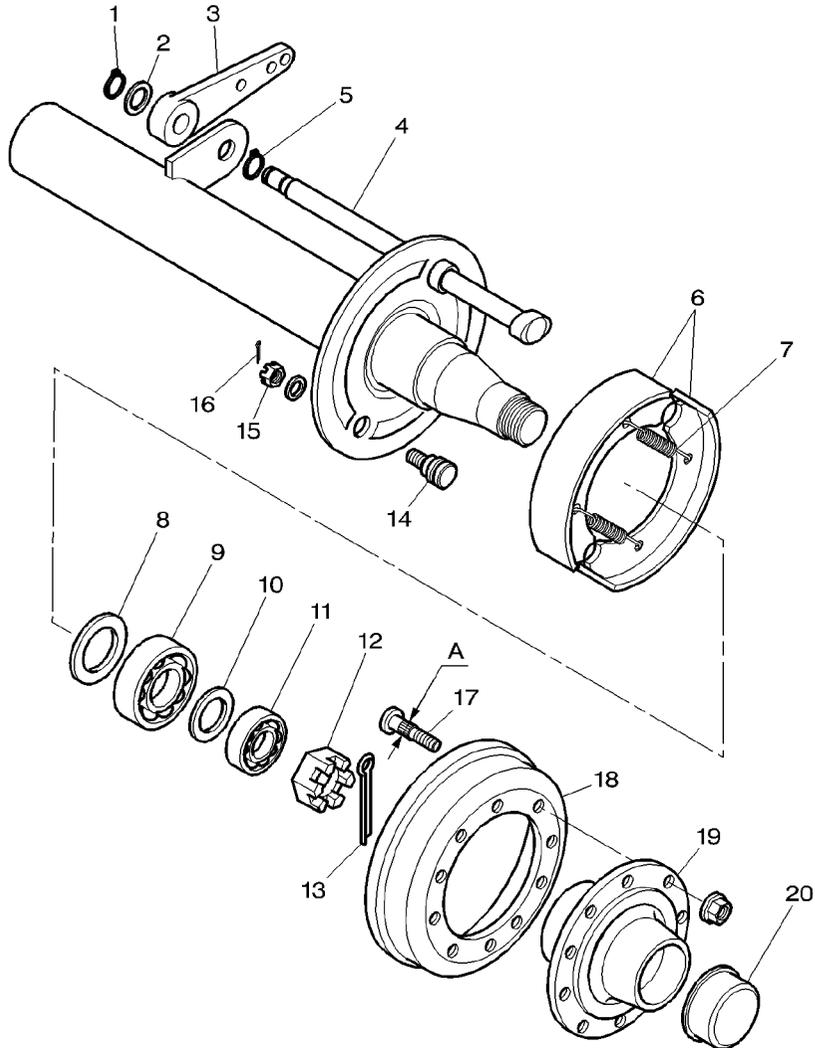

- 1 3901359M1
- 2 3901370M1
- 3 3901360M1
- 4 3901369M1
- 5 3901368M1
- 6 3904692M91
- 7 3901362M1
- 8 3901340M1
- 9 1440643X1
- 10 3901391M1
- 11 1440641X1
- 12 3901371M1
- 13 3901358M1
- 14 3901363M1
- 15 3901364M1
- 16 3901361M1
- 17 3901333M1
- 17 3904020M1
- 18 3901366M1
- 18 3904022M1
- 19 3901367M1
- 19 3904021M1
- 20 3901365M1

M48

- ➔ 190LB-50100
- A = 23 MM
- ➔ 190LB-50101
- A = 19 MM
- ➔ 190LB-50100
- ➔ 190LB-50101
- ➔ 190LB-50100
- ➔ 190LB-50101

- 1 CIRCLIP
- 1 WASHER
- 1 LEVER
- 1 SHAFT
- 1 CIRCLIP
- 2 KIT, SHOE
- 2 SPRING
- 1 OIL SEAL
- 1 BEARING ASSY
- 1 SEAL
- 1 BEARING
- 1 NUT
- 1 CLIP
- 1 PIVOT
- 1 NUT
- 1 PIN
- 10 STUD
- 10 STUD
- 1 DRUM
- 1 DRUM
- 1 HUB
- 1 HUB
- 1 CAP

- CIRCLIP
- ANELLO ELASTICO
- RONDELLA
- RONDELLA
- LEVIER
- LEVA
- ARBRE
- ALBERO
- CIRCLIP
- ANELLO ELASTICO
- JEU SABOTS
- KIT SUOLE
- RESSORT
- MOLLA
- BAGUE ETANCHEITE
- BOCCOLA PARAOLIO
- ROULEMENT
- CUSCINETTO COMPL
- JOINT ETANCHEITE
- ANELLO RACCORD
- COUSSINET
- CUSCINETTO
- ECROU
- DADO
- CLIP
- FERMAGLIO
- PIVOT
- CARDINE
- ECROU
- DADO
- GOUPILLE
- PERNO
- GOUJON
- PRIGIONIERO
- GOUJON
- PRIGIONIERO
- TAMBOUR
- TAMBURO
- TAMBOUR
- TAMBURO
- MOYEU
- MOZZO
- MOYEU
- MOZZO
- CHAPEAU
- CAPUCHON
- SEEGERING
- GRAPA CIRCULAR
- UNTERLEGSCHIEBE
- ARANDELA
- HEBEL
- PALANCA
- WELLE
- ARBOL
- SEEGERING
- GRAPA CIRCULAR
- BODENPLATTENSATZ
- JUEGO ZAPATAS
- FEDER
- RESORTE
- OELDICHRING
- BUJE RETENACEITE
- RADIALLAGER
- RODAMIENTO RAD
- DICHRING
- ARENDELA D'JUNTA
- LAGER
- COJINETE
- MUTTER
- TUERCA
- SHELLE
- CLIP
- DREHZAPFEN
- PIVOTE
- MUTTER
- TUERCA
- BOLZEN
- PASADOR
- STEBBOLZEN
- CHAVETA ROSCADO
- STEBBOLZEN
- CHAVETA ROSCADO
- TROMMEL
- TAMBOR
- TROMMEL
- TAMBOR
- NABE
- CUBO
- NABE
- CUBO
- KAPPE
- TAPA

Wheel
Roues
Rader
Ruota
Rueda

60-155

5 BA28 005 A

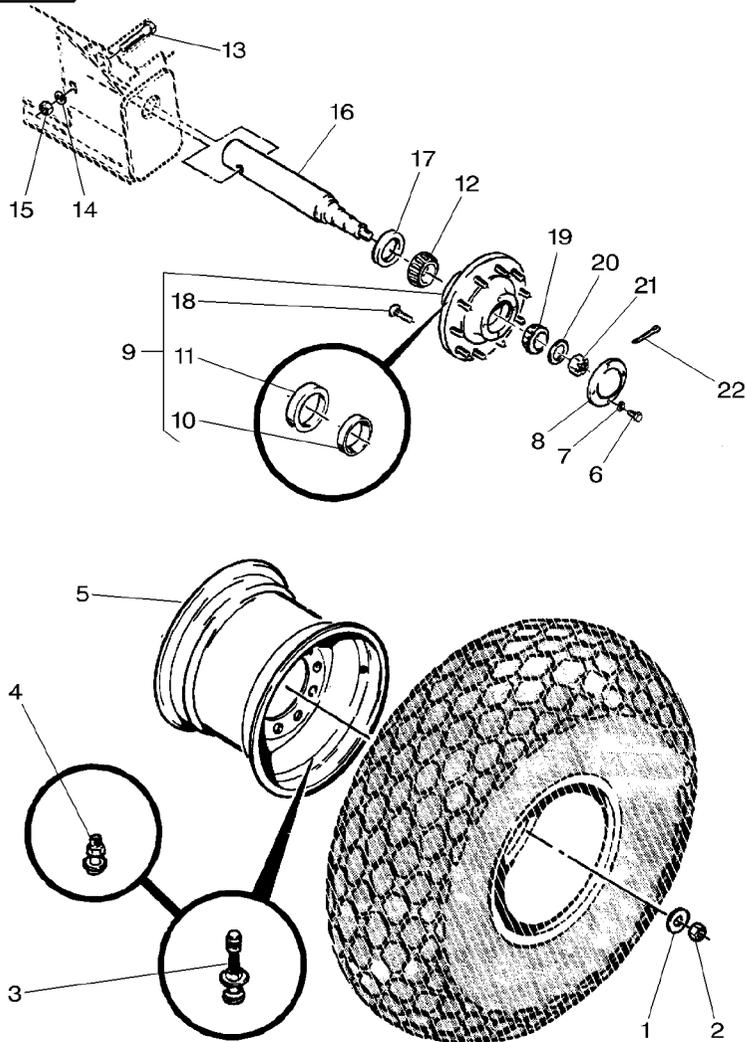

1	826271		20	WASHER	RONDELLE	UNTERLEGSCHIEBE
2	700706194	3/4"-16	20	NUT	RONDELLA	ARANDELA
3	7027469		2	PRESSURE VALVE	ECROU	MUTTER
4	7027477		2	PLUG	DADO	TUERCA
5	700714441	DWH 25 X 26	2	WHEEL	VALVE	DRUCKVENTIL
6	70922925	5/16"-18 X 3/4	2	PLUG	VALVOLA PRESSION	VALVULA PRESION
7	353446X1	5/16"	2	WHEEL	BOUCHON	VERSCHL.STOPFEN
8	826578		8	CAPSCREW	TAPPO	TAPON
9	700112940		8	LOCK WASHER	ROUE	RAD
10	300975M1	9	2	HUB	RUOTA	RUEDA
11	KB5012B	9	8	CAPSCREW	VIS BOUCHON	HUTSCHRAUBE
12	7713134		2	HUB	TAPPO A VITE	TORNILLO TAPON
13	369358X1	5/8"-11 X 4-1/2	8	LOCK WASHER	RONDELLE FREIN	FEDERRING
14	353433X1	5/8"	2	CAP	ROSETTA DENTELL.	ARANDELA GROWER
15	375099X1	5/8"-11	2	CAP	CHAPEAU	KAPPE
16	700112942P		2	HUB	CAPUCHON	TAPA
17	7744519		2	CUP	MOYEU	NABE
18	826545	9 3/4"-16 X 2-1/2	2	CUP	MOZZO	CUBO
19	300974M1		2	CUP	COUPELLE	LAUFRING
20	353768X1	1"-1/2	2	CUP	SCODELLINO	CUBETA
21	704601	1"-1/2-12	2	CUP	COUPELLE	LAUFRING
22	375095X1	5/16" X 3	2	BEARING CONE	SCODELLINO	CUBETA
			2	BEARING CONE	CONE ROULEMENT	LAGERINNENRING
			2	SCREW	CONO CUSCINETTO	CONO COJINETE
			2	LOCK WASHER	VIS	SCHRAUBE
			2	NUT UNC	VITE	TORNILLO
			2	SPINDLE	RONDELLE FREIN	FEDERRING
			2	SEAL	ROSETTA DENTELL.	ARANDELA GROWER
			20	BOLT	ECROU UNC	MUTTER UNC
			2	BEARING	DADO UNC	TUERCA UNC
			2	WASHER	FUSEE	SPINDEL
			2	NUT	FUSELLO	MANGUETA
			2	PIN	JOINT ETANCHEITE	DICHTRING
					ANELLO RACCORD	ARENDELA D'JUNTA
					BOULON	MASCH.SCHRAUBE
					BULLONE	ESPIGA/BULON
					COUSSINET	LAGER
					CUSCINETTO	COJINETE
					RONDELLE	UNTERLEGSCHIEBE
					RONDELLA	ARANDELA
					ECROU	MUTTER
					DADO	TUERCA
					GOUPILLE	BOLZEN
					PERNO	PASADOR

--	--	--

70

Hydraulic
Hydraulique
Hydraulik
Idraulica
Hidraulico

70-5

Front - Up To ...
Avant - Jusqu' Au ...
Vorne - Bis ...
Anteriore - Fimo Alla ...
Delantero - Hasta ...

5 BA55 004 A

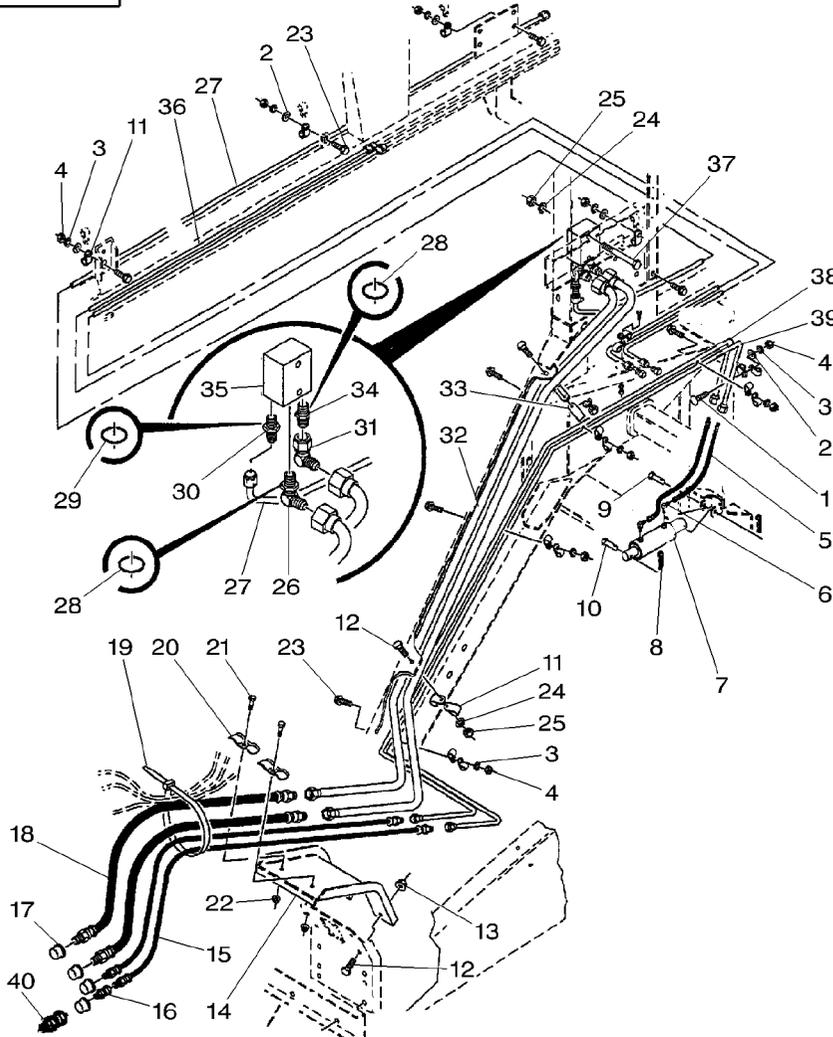

1	364533X1	5/16"-18 X 1-1/4	1 BOLT	BOULON	MASCH.SCHRAUBE
2	Y705525	5/16"	5 WASHER	BULLONE	ESPIGA/BULON
3	353446X1	5/16"	9 LOCK WASHER	RONDELLE	UNTERLEGSCHIEBE
4	355565X1	5/16"-18	9 NUT UNC	RONDELLA	ARANDELA
5	843037		2 HOSE	RONDELLE FREIN	FEDERRING
6	70920316		2 ELBOW	ROSETTA DENTELL.	ARANDELA GROWER
7	700726495	70-35 No 1	1 HYDRAULIC, CYLIN	ECROU UNC	MUTTER UNC
8	354070X1	7075625	2 PIN	DADO UNC	TUERCA UNC
9	63495	5/8" X 2-1/2	1 CLIP	DURITE	SCHLAUCH
10	63693	5/8" X 2	1 PIN	TUBO FLESSIBILE	FLEXIBLE
11	70928931		14 CLAMP	COUDE	WINKELSTUECK
12	353691X1	3/8"-16 X 1	6 BOLT UNC	GOMITO	CODO
13	Y704734	3/18"-16	4 LOCKNUT	VERIN HYDRAULI.	HYDRAULIK ZYLIND
14	700113640		1 SUPPORT	CILINDRO IDRAULI	CILINDRO IDRAULI
15	7872021		2 HOSE	GOUPILLE	BOLZEN
16	7846389		1 RESTRICTOR	PERNO	PASADOR
17	746677		4 CAP	CLIP	SHELLE
18	700706388		2 HOSE	FERMAGLIO	CLIP
19	70937133		2 TIE	GOUPILLE	BOLZEN
20	700129085		2 CLAMP	PERNO	PASADOR
21	368443X1	3/8"-16 X 1-1/2	2 BOLT UNC	COLLIER	HALTESHELLE
22	7704141	3/8"-16	2 LOCKNUT	FASCETTA	ABRAZADERA
23	7883333	5/16"-18 X 1	8 SCREW	BOULON UNC	MASCH.SCHRB.UNC
24	353434X1	3/8"	4 LOCK WASHER	BULLONE UNC	PERNO UNC
25	355566X1	3/8"-16	4 NUT UNC	ECROU BLOCAGE	SICHERUNGSMUTTER
26	70922974		1 ELBOW	AUTOBLOCCANTE	CONTRATUERCA
				SUPPORT	LAGERUNG
				SUPPORTO	DISPOS.DE SOSTEN
				DURITE	SCHLAUCH
				TUBO FLESSIBILE	FLEXIBLE
				LIMITEUR	SPARDUESE
				LIMITATORE	LIMITADOR
				CHAPEAU	KAPPE
				CAPUCHON	TAPA
				DURITE	SCHLAUCH
				TUBO FLESSIBILE	FLEXIBLE
				ATTACHE	KUPPL.STANGE
				TRAVERSA ATTACCO	BARRA DE ENLACE
				COLLIER	HALTESHELLE
				FASCETTA	ABRAZADERA
				BOULON UNC	MASCH.SCHRB.UNC
				BULLONE UNC	PERNO UNC
				ECROU BLOCAGE	SICHERUNGSMUTTER
				AUTOBLOCCANTE	CONTRATUERCA
				VIS	SCHRAUBE
				VITE	TORNILLO
				RONDELLE FREIN	FEDERRING
				ROSETTA DENTELL.	ARANDELA GROWER
				ECROU UNC	MUTTER UNC
				DADO UNC	TUERCA UNC
				COUDE	WINKELSTUECK
				GOMITO	CODO

Hydraulic
Hydraulique
Hydraulik
Idraulica
Hidraulico

70-5

Front - Up To ...
Avant - Jusqu' Au ...
Vorne - Bis ...
Anteriore - Fimo Alla ...
Delantero - Hasta ...

5 BA55 004 A

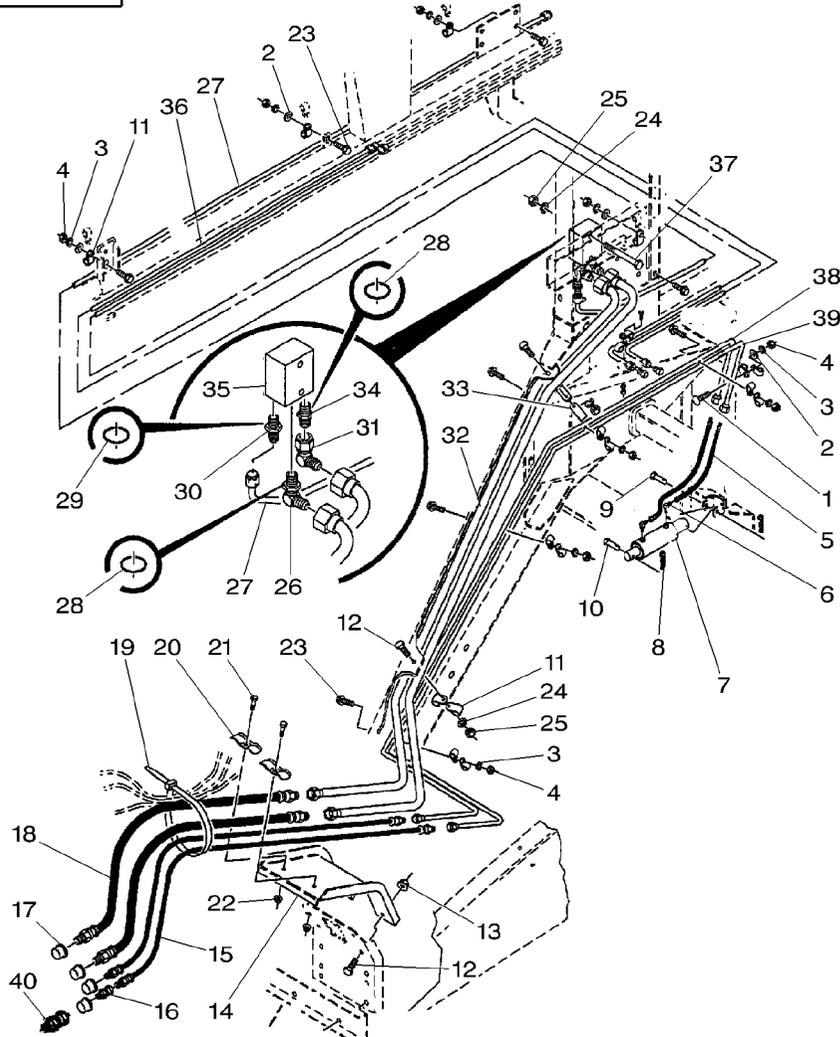

27	700706391	26	1 HOSE	DURITE	SCHLAUCH
28	70921205	30	2 O RING	TUBO FLESSIBILE	FLEXIBLE
29	831452M1		1 O RING	JOINT TORIQUE	O-RING
30	846634		1 CONNECTOR	ANELLO TENUTA	ANILLO FORMA 'O'
31	70919624		1 ELBOW	JOINT TORIQUE	O-RING
32	700706389		2 HOSE	ANELLO TENUTA	ANILLO FORMA 'O'
33	70926049		4 CLAMP	BOURNE	DOPPELNIPPEL
34	70922981		1 UNION	MORSETTO	CONECTOR
35	700706387	➔ 190LB-50100	1 CONTROL VALVE	COUDE	WINKELSTUECK
35	700709986	👁 70-20 No 1	1 CONTROL VALVE	GOMITO	CODO
36	700708334	➔ 190LB-50101	2 TUBE	DURITE	SCHLAUCH
37	353898X1	👁 70-20 No 1	2 BOLT UNC	TUBO FLESSIBILE	FLEXIBLE
38	700706703		1 TUBE	COLLIER	HALTESCHELLE
39	700706393		1 TUBE	FASCETTA	ABRAZADERA
40	3901294M1		1 COUPLING	RACCORD	VERSCHRAUBUNG
				RACCORDO	RACOR
				VALVE COMMANDE	REGELVENTIL
				DISTRIBUTORE IDR	VALVULA CONTROL
				VALVE COMMANDE	REGELVENTIL
				DISTRIBUTORE IDR	VALVULA CONTROL
				TUBE	ROHR
				TUBO	TUBO
		3/8"-16 X 3-1/4		BOULON UNC	MASCH.SCHRUB.UNC
				BULLONE UNC	PERNO UNC
				TUBE	ROHR
				TUBO	TUBO
				TUBE	ROHR
				TUBO	TUBO
		[A]		CRABOT	KUPPLUNG
		1/2" BSP		INNESTO	ACOPLAMIENTO

[A] EUROPE ONLY
EUROPE SEULEMENT
NUR FUER EUROPA
SOLO EUROPA
EUROPA SOLAMENTE

Hydraulic
Hydraulique
Hydraulik
Idraulica
Hidraulico

70-10

Front - From ...
Avant - A Partir Du ...
Vorne - Ab ...
Anteriore - Dalla ...
Delantero - A Partir Del ...

5-BA55-012-C

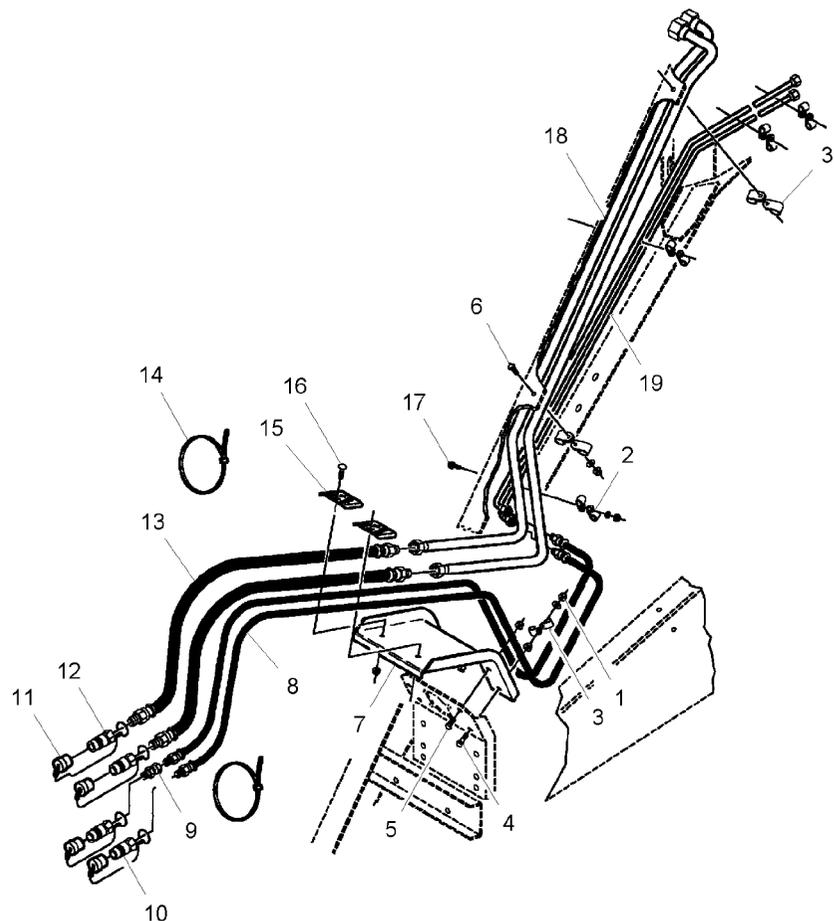

1	★Y705533	3/8"	1	WASHER	RONDELLE	UNTERLEGSCHIEBE
1	★700711238	3/8"-16	1	LOCKNUT	RONDELLA	ARANDELA
2	★70928931		1	LOCKNUT	ECROU BLOCAGE	SICHERUNGSMUTTER
2	★70928931		8	CLAMP	AUTOBLOCCANTE	CONTRATUERCA
3	70926049	3/4"		CLAMP	COLLIER	HALTESCHELLE
4	★70921969	3/8"-16 X 1-1/2	6	CLAMP	FASCETTA	ABRAZADERA
4	★Y704734	3/8"-16		CLAMP	COLLIER	HALTESCHELLE
5	★70921210	3/8"-16 X 1	1	CAPSCREW	FASCETTA	ABRAZADERA
5	★Y704734	3/8"-16	1	CAPSCREW	VIS BOUCHON	HUTSCHRAUBE
6	★70921210	3/8"-16 X 1	1	LOCKNUT	TAPPO A VITE	TORNILLO TAPON
6	★Y705533	3/8"	1	LOCKNUT	ECROU BLOCAGE	SICHERUNGSMUTTER
6	★700711238	3/8"-16	3	CAPSCREW	AUTOBLOCCANTE	CONTRATUERCA
7	★700150657P	➡ HN 91150	3	CAPSCREW	VIS BOUCHON	HUTSCHRAUBE
7	★700153220P	➡ HN 91151	3	LOCKNUT	TAPPO A VITE	TORNILLO TAPON
8	700711860		2	CAPSCREW	ECROU BLOCAGE	SICHERUNGSMUTTER
9	7846389		2	CAPSCREW	AUTOBLOCCANTE	CONTRATUERCA
10	★7746688		2	WASHER	VIS BOUCHON	HUTSCHRAUBE
11	★700718082		2	WASHER	TAPPO A VITE	TORNILLO TAPON
12	★700724190		2	LOCKNUT	RONDELLE	UNTERLEGSCHIEBE
13	★700706388		2	LOCKNUT	RONDELLA	ARANDELA
14	★70937133		2	LOCKNUT	ECROU BLOCAGE	SICHERUNGSMUTTER
15	★700129085		2	LOCKNUT	AUTOBLOCCANTE	CONTRATUERCA
16	★768036	3/8"-16 X 1-1/2	1	SUPPORT	SUPPORT	LAGERUNG
16	★Y704734	3/8"-16	1	SUPPORT	SUPPORTO	DISPOS.DE SOSTEN
17	★7883333	5/16"-18 X 1	1	SUPPORT	SUPPORT	LAGERUNG
17	★Y705525	5/16"	1	SUPPORT	SUPPORTO	DISPOS.DE SOSTEN
17	★70931277	5/16"-18	2	HOSE	DURITE	SCHLAUCH
			1	RESTRICTOR	TUBO FLESSIBILE	FLEXIBLE
			2	NIPPLE	LIMITEUR	SPARDUESE
			2	NIPPLE	LIMITATORE	LIMITADOR
			4	CAP	GRAISSEUR COUDE	NIPPEL
			2	GREASER	NIPPLIO	NIPLE
			2	HOSE	CHAPEAU	KAPPE
			2	TIE	CAPUCHON	TAPA
			2	CLAMP	GRAISSEUR	FETTNIPEL
			2	BOLT	INGRASSATORE	ENGRASADOR
			2	LOCKNUT	DURITE	SCHLAUCH
			4	SCREW	TUBO FLESSIBILE	FLEXIBLE
			4	WASHER	ATTACHE	KUPPL.STANGE
			4	NUT	TRAVERSA ATTACCO	BARRA DE ENLACE
					COLLIER	HALTESCHELLE
					FASCETTA	ABRAZADERA
					BOULON	MASCH.SCHRAUBE
					BULLONE	ESPIGA/BULON
					ECROU BLOCAGE	SICHERUNGSMUTTER
					AUTOBLOCCANTE	CONTRATUERCA
					VIS	SCHRAUBE
					VITE	TORNILLO
					RONDELLE	UNTERLEGSCHIEBE
					RONDELLA	ARANDELA
					ECROU	MUTTER
					DADO	TUERCA

Hydraulic
Hydraulique
Hydraulik
Idraulica
Hidraulico

70-10

Front - From ...
Avant - A Partir Du ...
Vorne - Ab ...
Anteriore - Dalla ...
Delantero - A Partir Del ...

5-BA55-012-C

18 * 700706389

2 HOSE

DURITE
TUBO FLESSIBILE
ENSEMBLE TUBE
TUBO COMPL.

SCHLAUCH
FLEXIBLE
ROHR KPL
CONJ.DE TUBO

19 * 700716375

2 TUBE ASSY

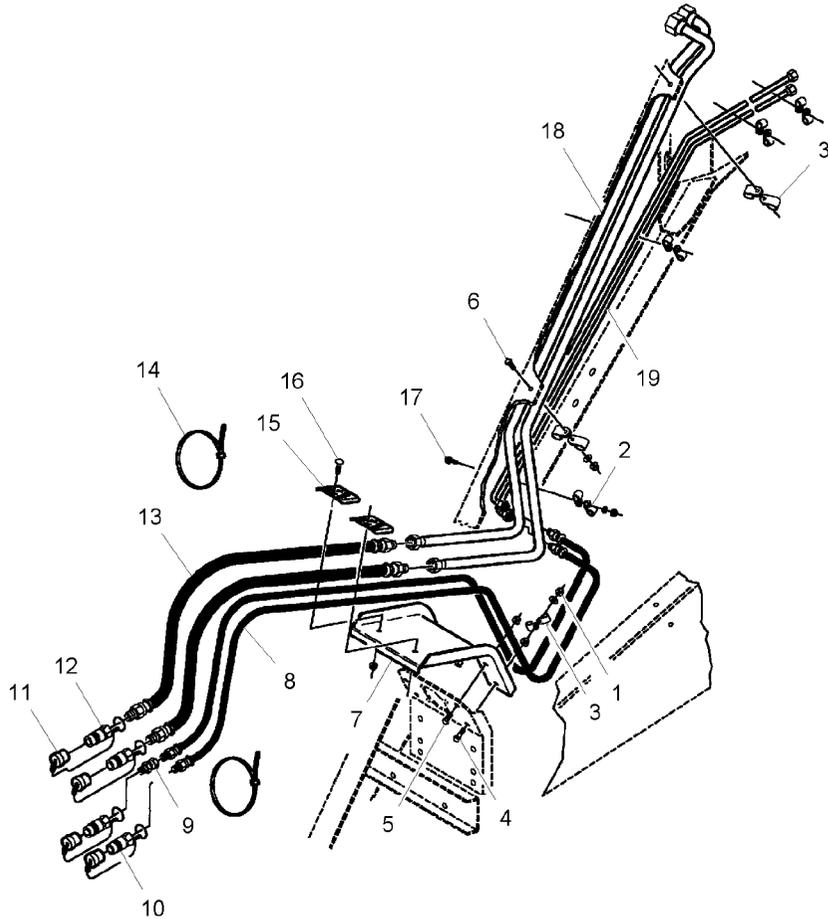

Hydraulic
Hydraulique
Hydraulik
Idraulica
Hidraulico

70-15

Front - From ...
Avant - A Partir Du ...
Vorne - Ab ...
Anteriore - Dalla ...
Delantero - A Partir Del ...

5-BA55-013-B

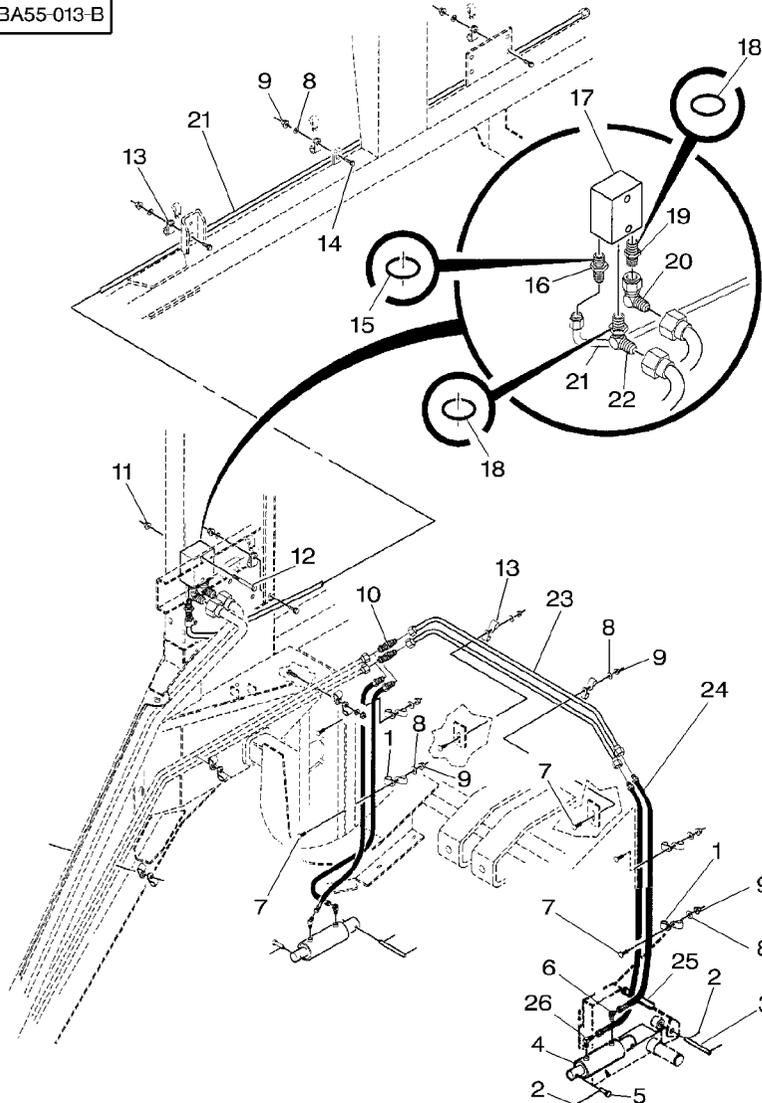

1	70925617	1/2"	8	CLAMP	COLLIER	HALTESCHELLE
2	★62182	5/32" X 1-1/4	6	PIN	FASCETTA	ABRAZADERA
3	700119558		6	PIN	GOUPILLE	BOLZEN
4	★700726495	➡ HK 91220	2	HYDRAULIC, CYLIN	PERNO	PASADOR
4	★700726495	👁 70-35 No 1	2	HYDRAULIC, CYLIN	GOUPILLE	PASADOR
5	63693	👁 70-40 No 1	2	HYDRAULIC, CYLIN	PERNO	PASADOR
6	70920316	➡ HK 91221	2	HYDRAULIC, CYLIN	VERIN HYDRAULI.	HYDRAULIK ZYLIND
7	★7700578	👁 70-25 No 1	2	HYDRAULIC, CYLIN	CILINDRO IDRAULI	CILINDRO IDRAULI
8	Y705525	5/16"	2	ELBOW	VERIN HYDRAULI.	HYDRAULIK ZYLIND
9	70931277	5/16"-18	2	PIN	CILINDRO IDRAULI	CILINDRO IDRAULI
10	70921297		2	ELBOW	GOUPILLE	BOLZEN
11	Y704734	3/8"-16	2	SCREW	PERNO	PASADOR
12	★70922918	3/8"-16 X 3-1/4	6	SCREW	COUDE	WINKELSTUECK
13	70928931		10	WASHER	GOMITO	CODO
14	7883333	5/16"-18 X 1	10	NUT	VIS	SCHRAUBE
15	★70921885	16	2	TEEPIECE	VITE	TORNILLO
16	★846634		2	LOCKNUT	RONDELLE	UNTERLEGSCHIEBE
17	★700709986	➡ HK 91220	2	LOCKNUT	RONDELLE	ARANDELA
17	700720233	👁 70-20 No 1	2	LOCKNUT	ECROU	MUTTER
17	700725829	➡ HK 91221	2	LOCKNUT	DADO	TUERCA
17	700725829	➡ HN 91150	2	LOCKNUT	TE	T-STUECK
17	700725829	👁 70-25 No 1	2	LOCKNUT	RACCORDO A T	PIEZA EN T
18	70921205	➡ HN 91151	2	LOCKNUT	ECROU BLOCAGE	SICHERUNGSMUTTER
19	70922981	👁 70-30 No 1	2	LOCKNUT	AUTOBLOCCANTE	CONTRATUERCA
20	70919624		2	LOCKNUT	VIS BOUCHON	HUTSCHRAUBE
21	700706391	➡ HN 91151	2	LOCKNUT	TAPPO A VITE	TORNILLO TAPON
22	70922974	👁 70-30 No 1	8	CLAMP	COLLIER	HALTESCHELLE
			4	SCREW	FASCETTA	ABRAZADERA
			1	O RING	VIS	SCHRAUBE
			1	O RING	VITE	TORNILLO
			1	CONNECTOR	JOINT TORIQUE	O-RING
			1	CONNECTOR	ANELLO TENUTA	ANILLO FORMA 'O'
			1	CONTROL VALVE	BORNE	DOPELNIPPEL
			1	CONTROL VALVE	MORSETTO	CONECTOR
			1	CONTROL VALVE	VALVE COMMANDE	REGELVENTIL
			1	CONTROL VALVE	DISTRIBUTORE IDR	VALVULA CONTROL
			1	CONTROL VALVE	VALVE COMMANDE	REGELVENTIL
			1	CONTROL VALVE	DISTRIBUTORE IDR	VALVULA CONTROL
			2	O RING	JOINT TORIQUE	O-RING
			1	UNION	ANELLO TENUTA	ANILLO FORMA 'O'
			1	UNION	RACCORD	VERSCHRAUBUNG
			1	ELBOW	RACCORDO	RACOR
			1	ELBOW	COUDE	WINKELSTUECK
			1	HOSE	GOMITO	CODO
			1	ELBOW	DURITE	SCHLAUCH
			1	ELBOW	TUBO FLESSIBILE	FLEXIBLE
			1	ELBOW	COUDE	WINKELSTUECK
			1	ELBOW	GOMITO	CODO

Hydraulic
Hydraulique
Hydraulik
Idraulica
Hidraulico

70-15

Front - From ...
Avant - A Partir Du ...
Vorne - Ab ...
Anteriore - Dalla ...
Delantero - A Partir Del ...

5-BA55-013-B

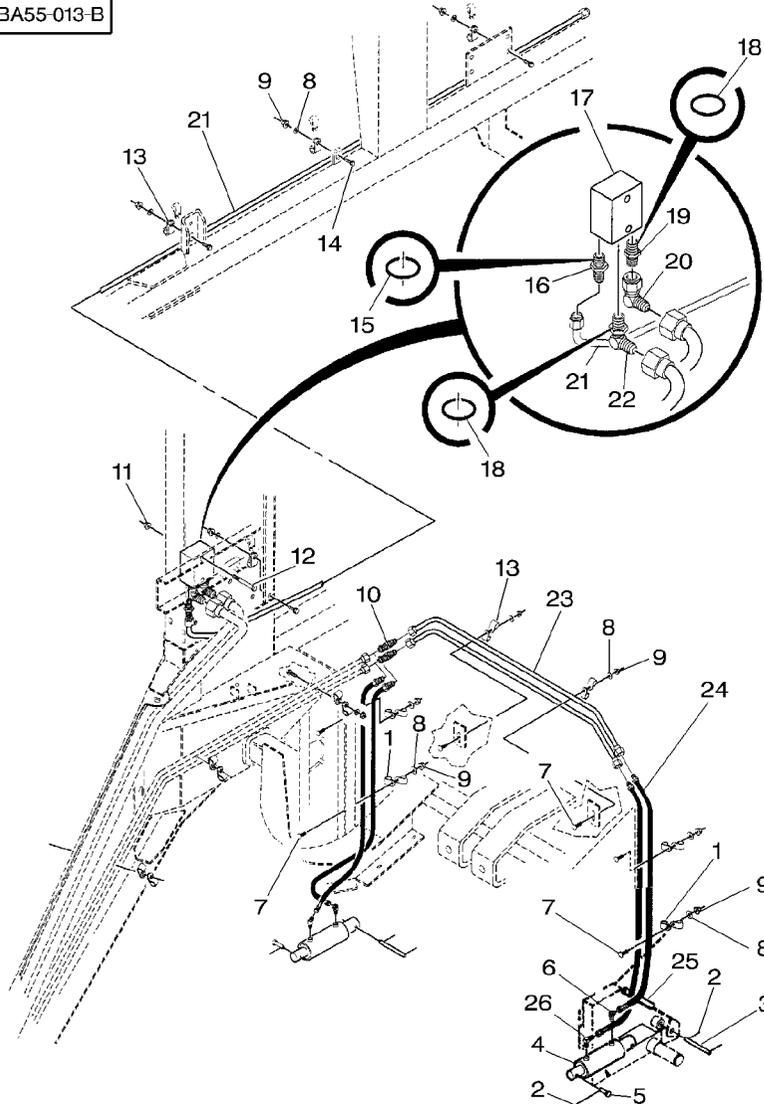

- 23 700716376
- 24 700716463
- 25 6477723
- 26 70919135

2 TUBE ASSY	ENSEMBLE TUBE TUBO COMPL.	ROHR KPL CONJ.DE TUBO
4 HYDRAULIC HOSE	DURITE HYDRAULIC TUBO HYDRAULICO	HYDRAUL.SCHLAUCH TUBO HYDRAULICO
2 GROMMET	PASSE FIL ANELLO PASSACAVO	GUMMITUELLE PASACABLE
2 ELBOW	COUDE GOMITO	WINKELSTUECK CODO

Hydraulic Flow Control
 Commande Hydraulique
 Hydraulischer Antrieb
 Mando Hidraulico
 Comando Idraulico

Valve
 Valve
 Ventil
 Valvola
 Valvula

70-20

Bale Tensioner - Up To H.K 91220
 Chambre De Compression - Jusqu'au H.K 91220
 Kanalverstellung - Bis H.K 91220
 Tenditore Balle - Fino Alla H.K 91220
 Tensor Paca - Hasta H.K 91220

5-BA57-003-C

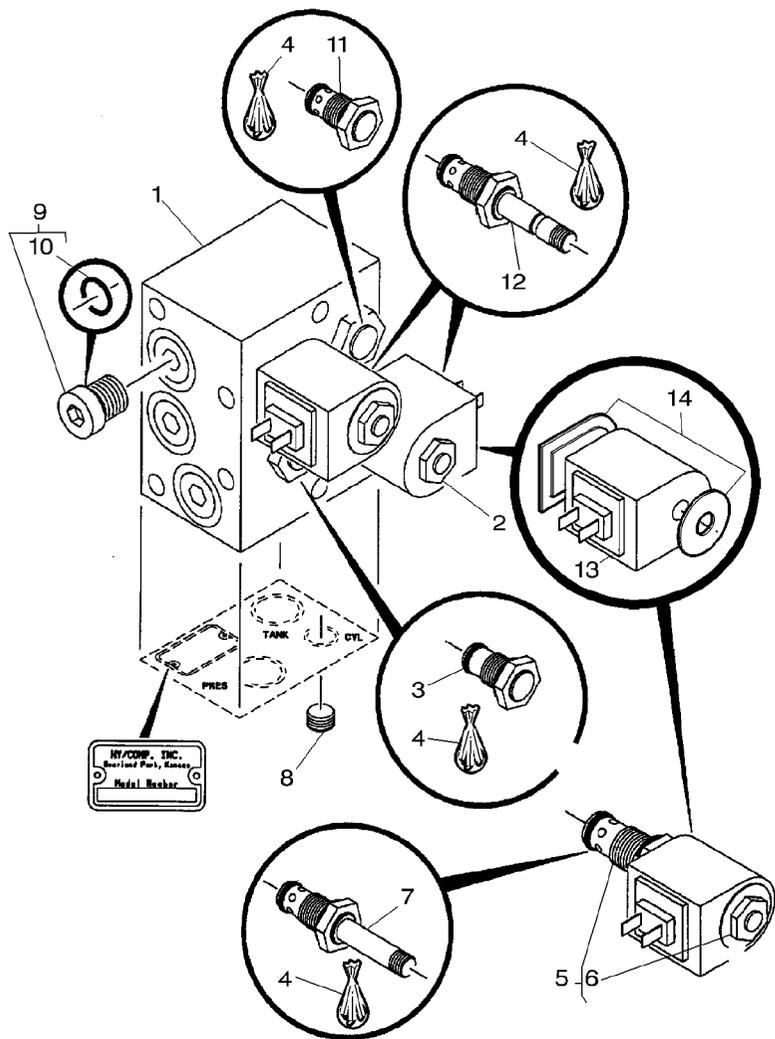

1	★700706387	➡	190LB-50100	1	CONTROL VALVE	VALVE COMMANDE	REGELVENTIL
1	★700709986	➡	190LB-50101	1	CONTROL VALVE	DISTRIBUTORE IDR	VALVULA CONTROL
2	700706151			1	NUT	VALVE COMMANDE	REGELVENTIL
3	700706602			1	PLUG	DISTRIBUTORE IDR	VALVULA CONTROL
4	700715662			5	KIT, SEAL	ECROU	MUTTER
5	700706386			1	VALVE.	DADO	TUERCA
6	700706156			1	NUT	BOUCHON	VERSCHL.STOPFEN
7	700706155			1	CARTRIDGE	TAPPO	TAPON
8	700706609			1	PLUG	JEU ETANCHEITE	DICHRINGSATZ
9	700706604			3	PLUG	KIT TENUTA	RETENES JUEGO
10	70921349			3	O RING	SOUPAPE	VENTIL
11	700707832			1	VALVE.	VALVOLA	VALVULA
12	700706153			2	CARTRIDGE	CARTOUCHE	PATRONE
13	700706605			3	COIL	CARTUCCIA	ELEMENTO FILTRO
13	700710176			3	SOLENOID	BOUCHON	VERSCHL.STOPFEN
14	700707826			1	KIT	TAPPO	TAPON
				3	O RING	BOUCHON	VERSCHL.STOPFEN
				3	SOLENOID	TAPPO	TAPON
				3	SOLENOID	JOINT TORIQUE	O-RING
				1	VALVE.	ANELLO TENUTA	ANILLO FORMA 'O'
				2	CARTRIDGE	SOUPAPE	VENTIL
				3	SOLENOID	VALVOLA	VALVULA
				3	SOLENOID	CARTOUCHE	PATRONE
				3	SOLENOID	CARTUCCIA	ELEMENTO FILTRO
				1	KIT	BOBINE	KNICKSCHUTZFEDER
				3	SOLENOID	BOBINA	BOBINA
				3	SOLENOID	SOLENOIDE	MAGNETSPULE
				3	SOLENOID	SOLENOIDE	SOLENOIDE
				1	KIT	JEU	SATZ
				1	KIT	KIT	JUEGO

[A] ORDER 700710176 + 700707826
 COMMANDER 700710176 + 700707826
 BESTELLEN 700710176 + 700707826
 ORDINARE 700710176 + 700707826
 PEDIR 700710176 + 700707826

Hydraulic Flow Control
 Commande Hydraulique
 Hydraulischer Antrieb
 Mando Hidraulico
 Comando Idraulico

Valve
 Valve
 Ventil
 Valvola
 Valvula

70-25

Bale Tensioner - From H.K 91221 - Up To H.N 91150
 Chambre De Compression - A Partir Du H.K 91221 - Jusqu' Au H.N 91150
 Kanalverstellung - Ab H.K 91221 - Bis H.N 91150
 Tenditore Balle - Dalla H.K 91221 - Fino Alla H.N 91150
 Tensor Paca - A Partir Del H.K 91221 - Hasta H.N 91150

5-BA57-008-B

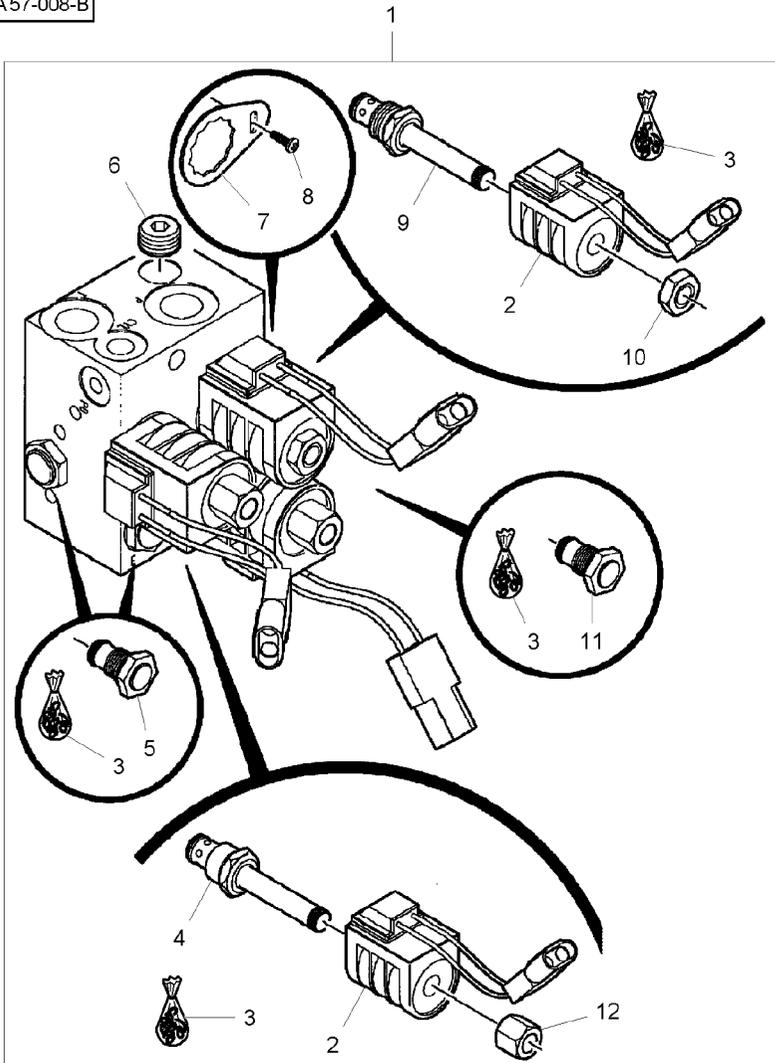

1	700720233		1	CONTROL VALVE	VALVE COMMANDE	REGELVENTIL
2	★700717218	1			DISTRIBUTORE IDR	VALVULA CONTROL
3	★700715929	1		3 COIL	BOBINE	KNICKSCHUTZFEDER
4	★1079721M1	1		4 KIT, SEAL	BOBINA	BOBINA
5	★700712917	1			JEU ETANCHEITE	DICHRINGSATZ
6	★700719201	1		2 SOLENOID VALVE	KIT TENUTA	RETENES JUEGO
7	★700716903	1			VALVE SOLENOIDE	MAGNETVENTIL
8	★700704132	1	No 6-32 X 3/8	2 VALVE CHECK	VALVOLASOLENOIDE	VALVULA SOLENOID
9	★700712823	1			VALVE CONTROLE	PRUEFVENTIL
10	★700712824	1		1 PLUG	VALVOLA RITEGNO	VALVULA D CIERRE
11	★700712924	1			BOUCHON	VERSCHL.STOPFEN
12	★700712821	1		3 PLATE	BOUCHON	TAPON
				3 SCREW	TAPPO	TAPON
					PLAQUE	PLATTE
					PIASTRA	PLATO
					VIS	SCHRAUBE
					VITE	TORNILLO
				1 CARTRIDGE	CARTOUCHE	PATRONE
					CARTUCCIA	ELEMENTO FILTRO
				1 NUT	ECROU	MUTTER
					DADO	TUERCA
				1 PLUG	BOUCHON	VERSCHL.STOPFEN
					TAPPO	TAPON
				2 NUT	ECROU	MUTTER
					DADO	TUERCA

Hydraulic Flow Control
 Commande Hydraulique
 Hydraulischer Antrieb
 Mando Hidraulico
 Comando Idraulico

Valve
 Valve
 Ventil
 Valvola
 Valvula

70-30

Bale Tensioner - From H.N 91151
 Chambre De Compression - A Partir Du H.N 91151
 Kanalverstellung - Ab H.N 91151
 Tenditore Balle - Dalla H.N 91151
 Tensor Paca - A Partir Del H.N 91151

5-BA57-011-C

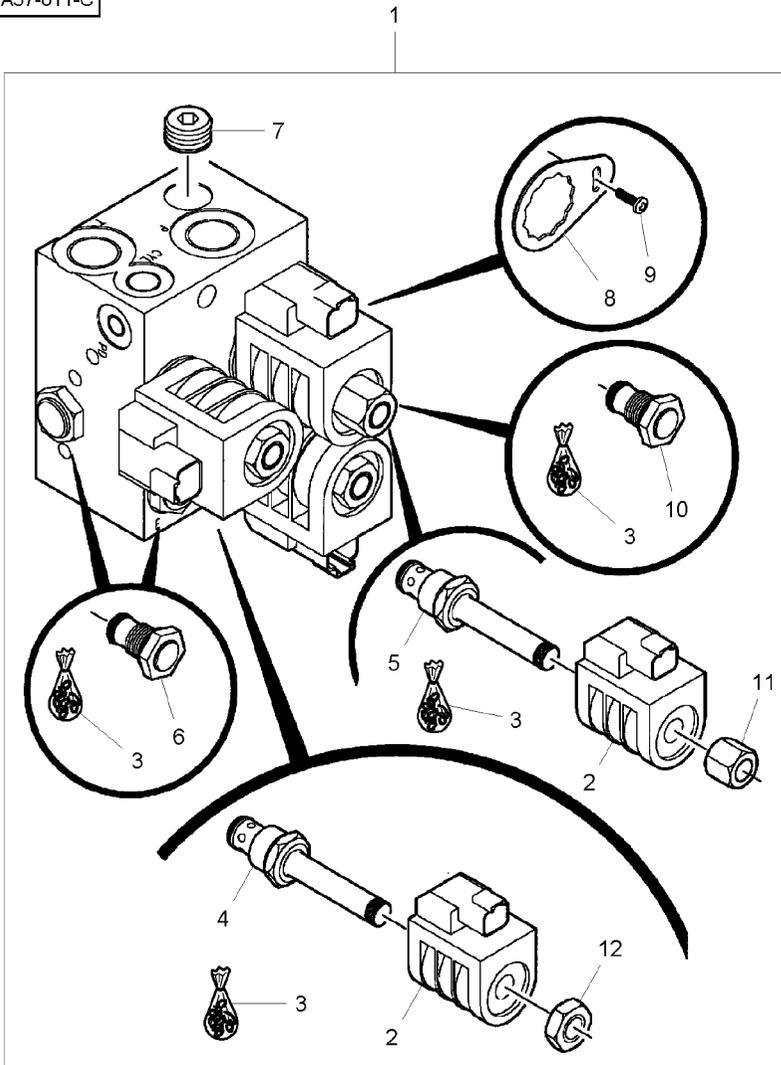

1	700725829		1	CONTROL VALVE	VALVE COMMANDE	REGELVENTIL
2	★700725827	1			DISTRIBUTORE IDR	VALVULA CONTROL
3	700715929	1		3 COIL	BOBINE	KNICKSCHUTZFEDER
4	1079721M1	1			BOBINA	BOBINA
5	★700712823	1		5 KIT, SEAL	JEU ETANCHEITE	DICHTRINGSATZ
6	700712917	1		2 SOLENOID VALVE	KIT TENUTA	RETENES JUEGO
7	700719201	1		1 CARTRIDGE	VALVE SOLENOIDE	MAGNETVENTIL
8	700716903	1			VALVOLA SOLENOIDE	VALVULA SOLENOID
9	700704132	1	No 6-32 X 3/8		CARTOUCHE	PATRONE
10	700712924	1		2 VALVE CHECK	CARTUCCIA	ELEMENTO FILTRO
11	★700712824	1		1 PLUG	VALVE CONTROLE	PRUEFVENTIL
12	★700712821	1			VALVOLA RITEGNO	VALVULA D CIERRE
				3 PLATE	BOUCHON	VERSCHL.STOPFEN
				2 SCREW	TAPPO	TAPON
					PLAQUE	PLATTE
				1 PLUG	PIASTRA	PLATO
				1 NUT	VIS	SCHRAUBE
				2 NUT	VITE	TORNILLO
					BOUCHON	VERSCHL.STOPFEN
					TAPPO	TAPON
					ECROU	MUTTER
					DADO	TUERCA
					ECROU	MUTTER
					DADO	TUERCA

Hydraulic Cylinder
 Verin Hydraulique
 Hydraulikzylinder
 Cilindros Idraulico
 Cilindro Hidraulico

70-35

➔ HK 91220

5 BA45 004 A

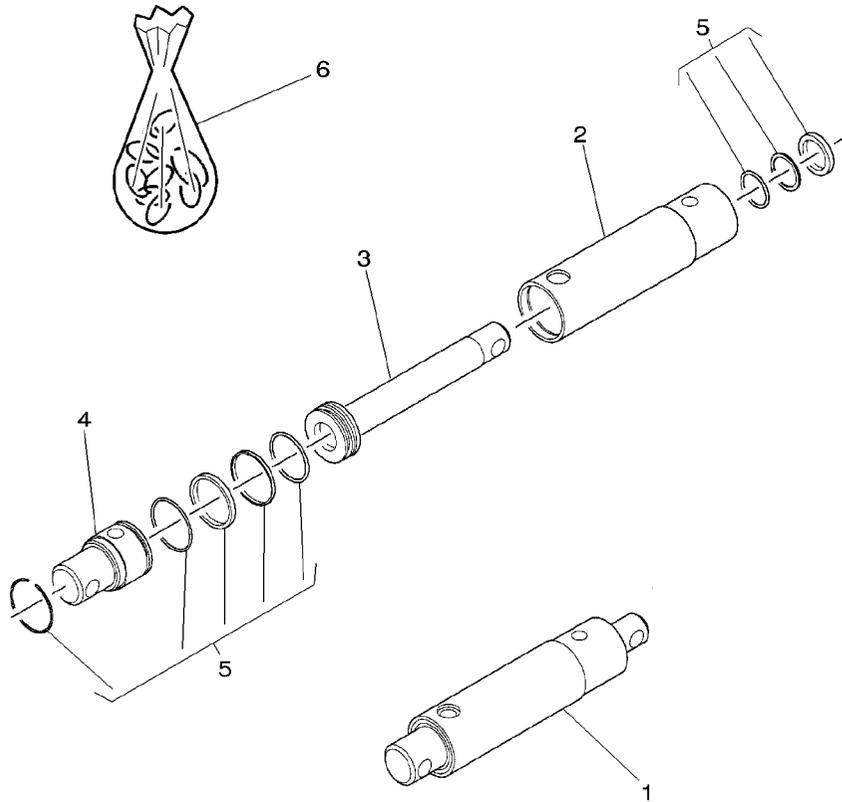

1 ✱ 700726495

●○ 7075625

2 7732258

1

3 7732266

1

4 7732241

1

5

1 ➔ REF. 6

6 7732274

1 HYDRAULIC, CYLIN

1 BARREL

1 ROD

1 HEAD

1 GASKET

1 KIT, JOINT

VERIN HYDRAULI.
 CILINDRO IDRAULI
 CORPS CYLINDRE
 CANNA
 TRINGLE
 ASTA
 TETE
 TESTA
 JOINT
 GUARNIZIONE
 JEU JOINTS
 KIT GIUNTO

HYDRAULIK ZYLIND
 CILINDRO IDRAULI
 ZYLINDERGEHAEUSE
 CUERPO CILINDRO
 STANGE
 VARILLA
 KOPF
 CULATA
 DICHTSCHEIBE
 EMPAQUETADURA.
 DICHTUNGSSATZ
 JUEGO JUNTAS

Hydraulic Cylinder
 Verin Hydraulique
 Hydraulikzylinder
 Cilindros Idraulico
 Cilindro Hidraulico

70-40

➔ HK 91221

5-BA45-010-A

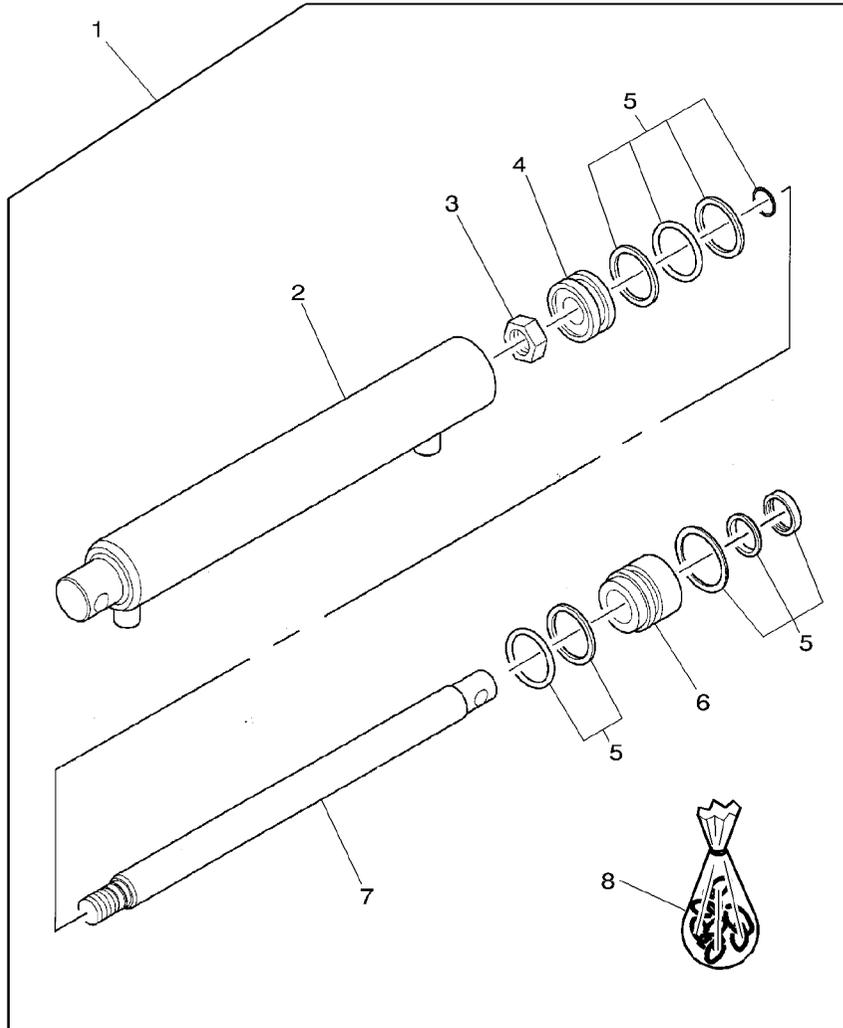

- 1 700726495
- 2
- 3 700707418
- 4 700707419
- 5
- 6 700711112
- 7 700726496
- 8 **700711954**

- 1 ➔ REF. 1
- 1 7/8"-14
- 1
- 1 ➔ REF. 8

- 1 HYDRAULIC, CYLIN
- 1 BARREL
- 1 NUT
- 1 PISTON
- 1 GASKET
- 1 GUIDE
- 1 CYLINDER ROD
- 1 KIT, SEAL

VERIN HYDRAULI.
 CILINDRO IDRAULI
 CORPS CYLINDRE
 CANNA
 ECROU
 DADO
 PISTON
 PISTONE
 JOINT
 GUARNIZIONE
 GUIDE
 GUIDA
 TIGE DE VERIN
 ASTA CILINDRO
 JEU ETANCHEITE
 KIT TENUTA

HYDRAULIK ZYLIND
 CILINDRO IDRAULI
 ZYLINDERGEHAEUSE
 CUERPO CILINDRO
 MUTTER
 TUERCA
 KOLBEN
 PISTON
 DICHTSCHEIBE
 EMPAQUETADURA.
 FUEHRUNG
 GUIDA
 KOLBENSTANGE
 BIELA DE CILINDR
 DICHRINGSATZ
 RETENES JUEGO

Hydraulic
Hydraulique
Hydraulik
Idraulica
Hidraulico

70-45

Bale Tensioner
Chambre De Compression
Kanalverstellung
Tenditore Balle
Tensor Paca

5 BA55 005 A

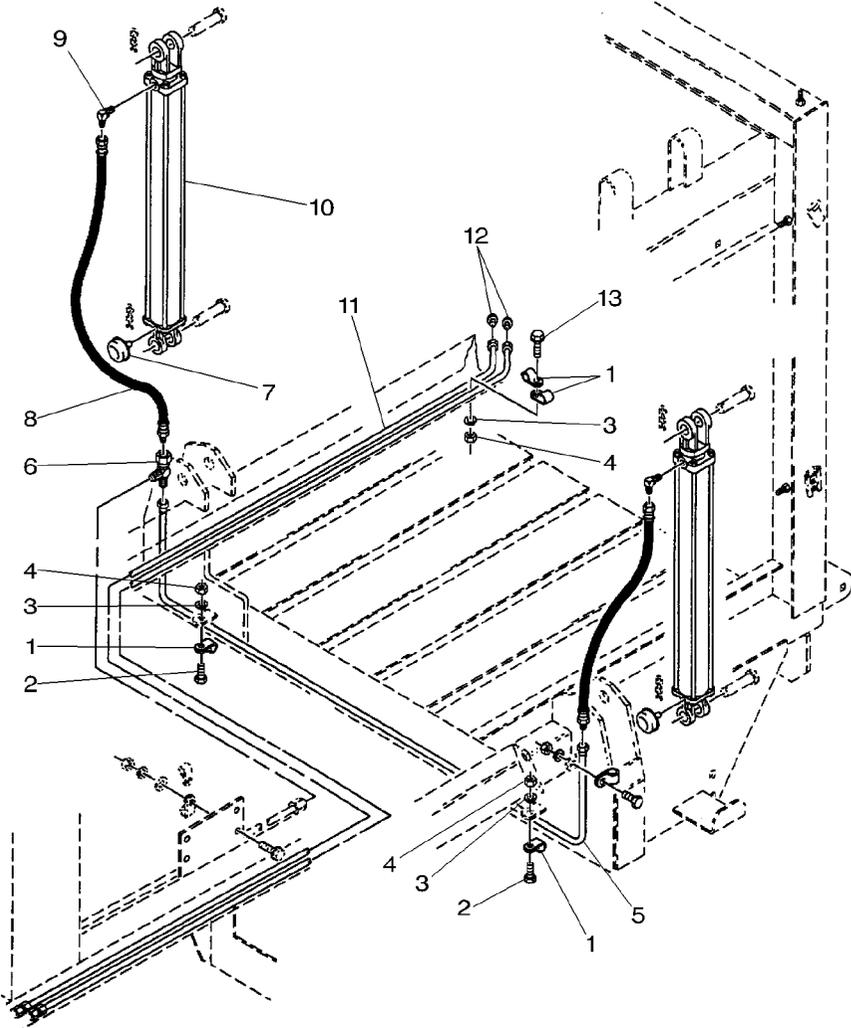

1	70928931		3	CLAMP	COLLIER	HALTESCHELLE
2	★70921332	5/16"-18 X 3/4	3	CAPSCREW	FASCETTA	ABRAZADERA
3	Y705525	5/16"	3	WASHER	VIS BOUCHON	HUTSCHRAUBE
4	70931277	5/16"-18	3	NUT	TAPPO A VITE	TORNILLO TAPON
5	700706392		3	TUBE	RONDELLA	UNTERLEGSCHIEBE
6	70921297		3	TEEPIECE	RONDELLA	ARANDELA
7	8799280		1	FILTER	ECROU	MUTTER
8	7872856		1	HOSE	DADO	TUERCA
9	70922322		1	ELBOW	TUBE	ROHR
10	700706338	👁 70-50 No 1	1	CYLINDER	TUBO	TUBO
11	700708335	➡ 190LB-50100	2	TUBE	TE	T-STUECK
12	7746183	➡ 190LB-50100	2	PLUG	RACCORDO A T	PIEZA EN T
13	7883333	➡ 190LB-50100	2	SCREW	FILTRO	FILTER
		5/16"-18 X 1	2		FILTRO	FILTRO
					DURITE	SCHLAUCH
					TUBO FLESSIBILE	FLEXIBLE
					COUDE	WINKELSTUECK
					GOMITO	CODO
					CYLINDRE	ZYLINDER
					CILINDRO	CILINDRO
					TUBE	ROHR
					TUBO	TUBO
					BOUCHON	VERSCHL.STOPFEN
					TAPPO	TAPON
					VIS	SCHRAUBE
					VITE	TORNILLO

Hydraulic Cylinder
 Verin Hydraulique
 Hydraulikzylinder
 Cilindros Idraulico
 Cilindro Hidraulico

70-50

5 BA45 005 A

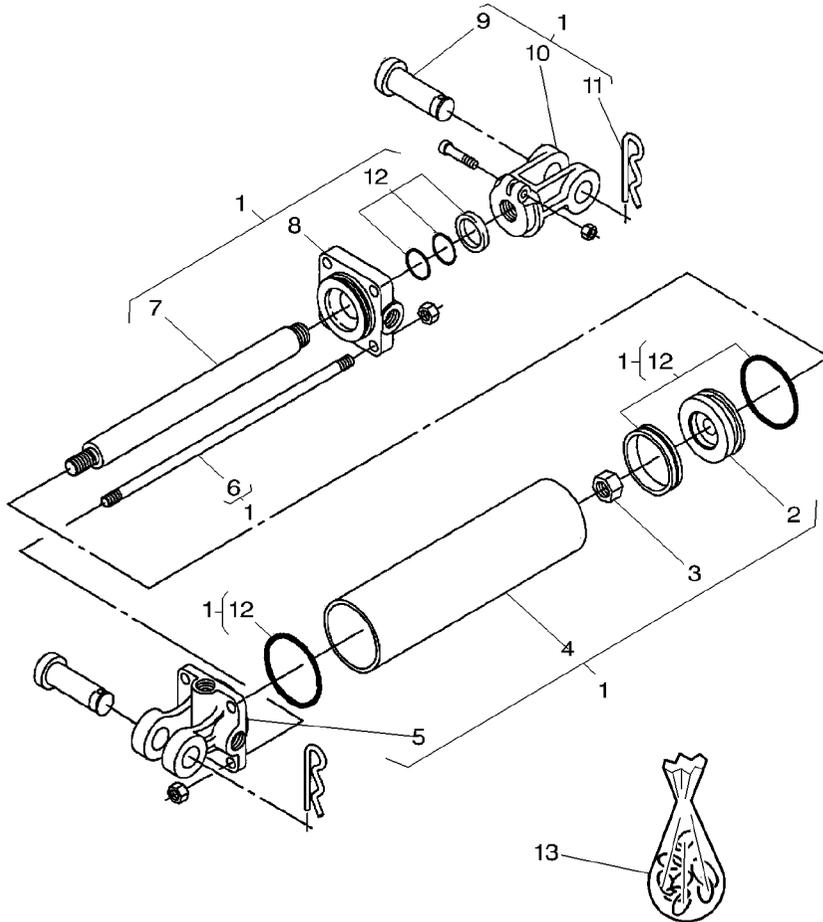

1	700706338		1	CYLINDER	CYLINDRE	ZYLINDER
2	700708626	1	1	PISTON	CILINDRO	CILINDRO
3	70930765	1	1	LOCKNUT	PISTON	KOLBEN
4	W238642B	1	1	TUBE	PISTONE	PISTON
5	79003555	1	1	BASE	ECROU BLOCAGE	SICHERUNGSMUTTER
6	79002917	1	4	TIE ROD	AUTOBLOCCANTE	CONTRATUERCA
7	700707318	1	1	ROD	TUBE	ROHR
8	79003552	1	1	HEAD	TUBO	TUBO
9	763201	1	2	PIN	SEMELLE	FUSSPLATTE
10	1045127M1	1	1	CLEVIS	BASE	BASE
11	932036	1 3/16" X 1-1/2	2	PIN	TRINGLERIE	ZUGSTANGE
12		1 REF. 13	1	GASKET	TIRANTE	BRAZO DE ENLACE
13	700708625		1	KIT, SEAL	TRINGLE	STANGE
			1		ASTA	VARILLA
			1		TETE	KOPF
			1		TESTA	CULATA
			1		GOUPILLE	BOLZEN
			1		PERNO	PASADOR
			1		CHAPE	GABELSTUECK
			1		GANCIO D'ATTACCO	GANCHO SEGURI.
			1		GOUPILLE	BOLZEN
			1		PERNO	PASADOR
			1		JOINT	DICHTSCHEIBE
			1		GUARNIZIONE	EMPAQUETADURA.
			1		JEU ETANCHEITE	DICHTRINGSATZ
			1		KIT TENUTA	RETENES JUEGO

Knotter
 Noueur
 Binder
 Legatore
 Anudadora

70-55

Fan
 Ventilateur
 Lufter
 Ventilatore
 Ventilador

5-BA06-046-B

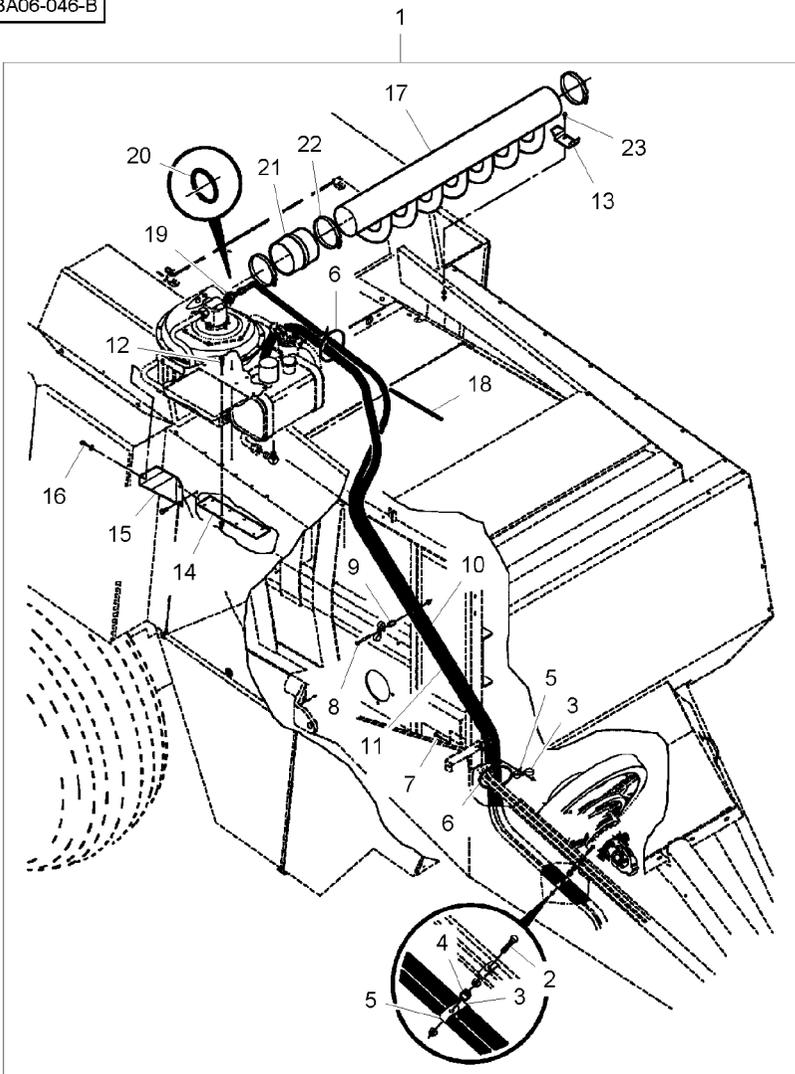

1	MK40955	70-60 No 1	1	KIT, ATTACHMENT	JEU ACCESSOIRES	SATZ ANBAUTEILE
2	873141	1 3/8"-16 X 2-1/2	1	CAPSCREW	KIT ACCESSORI	JUEGO ACCESORIO
2	700711238	1 3/8"-16	2	LOCKNUT	VIS BOUCHON	HUTSCHRAUBE
3	70929160	1 1"	3	CLAMP	TAPPO A VITE	TORNILLO TAPON
4	6553804	1	1	SPACER	ECROU BLOCAGE	SICHERUNGSMUTTER
5	70926049	1 3/4"	3	CLAMP	AUTOBLOCCANTE	CONTRATUERCA
6	70935468	1	2	TIE	COLLIER	HALTESCHELLE
7	700711084	1 3/8"-16 X 1-1/2	1	SCREW	FASCETTA	ABRAZADERA
7	700711238	1 3/8"-16	2	LOCKNUT	ENTRETOISE	ABSTANDSTUECK
8	354273X1	1 3/8"-16 X 3	1	BOLT UNC	DISTANZIALE	DISCO ESPACIADOR
8	700711238	1 3/8"-16	1	LOCKNUT	COLLIER	HALTESCHELLE
9	6605315	1	1	HUB	FASCETTA	ABRAZADERA
10	700717865	1	1	HYDRAULIC HOSE	ATTACHE	KUPPL.STANGE
11	700718207	1	1	HYDRAULIC HOSE	TRAVERSA ATTACCO	BARRA DE ENLACE
12	7883333	1 5/16"-18 X 1	4	SCREW	VIS	SCHRAUBE
12	Y704726	1 5/16"-18	4	LOCKNUT	VITE	TORNILLO
13	700149725P	1	1	CHANNEL	ECROU BLOCAGE	SICHERUNGSMUTTER
14	700149723P	1	1	STRAP	AUTOBLOCCANTE	CONTRATUERCA
15	700149741P	1	1	SUPPORT	CANAL	KANAL
16	7883325	1 5/16"-18 X 3/4	3	SCREW	PROFILATO	CANAL
16	Y705525	1 5/16"	3	WASHER	PATTE	LASCHE
17	700149720P	1	1	MANIFOLD	CORREGGIA	FAJA
18	700105144	1	1	GROMMET	SUPPORT	LAGERUNG
19	700701753	1	1	ADAPTOR	SUPPORTO	DISPOS.DE SOSTEN
20	70921206	19	1	O RING	VIS	SCHRAUBE
21	700717760	1	1	ADAPTOR	VITE	TORNILLO
			3	WASHER	RONDELLE	UNTERLEGSCHHEIBE
			1	MANIFOLD	RONDELLA	ARANDELA
			1	GROMMET	COLLECTEUR	KRUEMMER
			1	ADAPTOR	COLLETTORE	MULTIPLE
			1	O RING	PASSE FIL	GUMMITUELLE
			1	ADAPTOR	ANELLO PASSACAVO	PASACABLE
			1	ADAPTOR	ADAPTATEUR	REDUZIERNIPPEL
			1	ADAPTOR	ADATTATORE	ADAPTADOR
			1	ADAPTOR	JOINT TORIQUE	O-RING
			1	ADAPTOR	ANELLO TENUTA	ANILLO FORMA 'O'
			1	ADAPTOR	ADAPTATEUR	REDUZIERNIPPEL
			1	ADAPTOR	ADATTATORE	ADAPTADOR

Knotter
 Noueur
 Binder
 Legatore
 Anudadora

70-55

Fan
 Ventilateur
 Lufter
 Ventilatore
 Ventilador

5-BA06-046-B

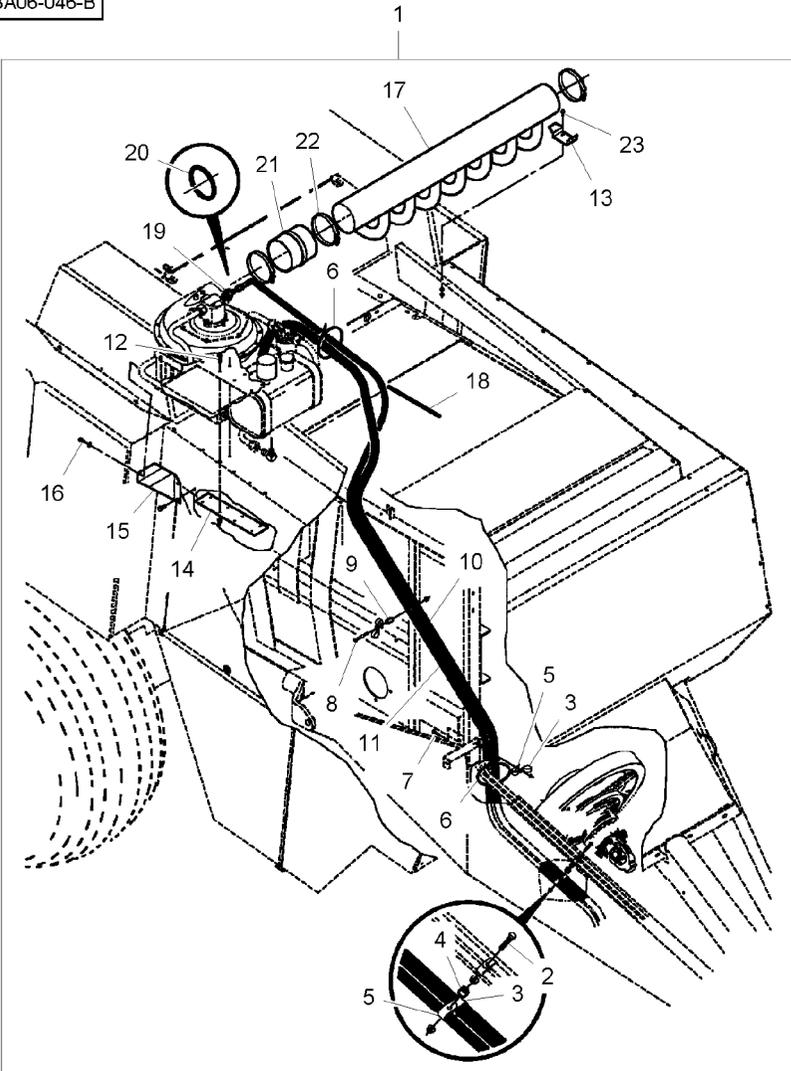

22★700717761	1	3 CLAMP	COLLIER FASCETTA	HALTESCHELLE ABRAZADERA
23★7883325	1 5/16"-18 X 3/4	2 SCREW	VIS VITE	SCHRAUBE TORNILLO
23★Y705525	1 5/16"	2 WASHER	RONDELLE RONDELLA	UNTERLEGSCHIEBE ARANDELA
23★Y704726	1 5/16"-18	2 LOCKNUT	ECROU BLOCAGE AUTOBLOCCANTE	SICHERUNGSMUTTER CONTRATUERCA

Knotter
 Noueur
 Binder
 Legatore
 Anudadora

70-60

Blower Kitit (Continued)
 Jeu Ventilateur (Suite)
 Satz Ventilator (Folge)
 Gioco Ventola (Seguito)
 Juego Ventilador (Sigüe)

5-BA06-024-B

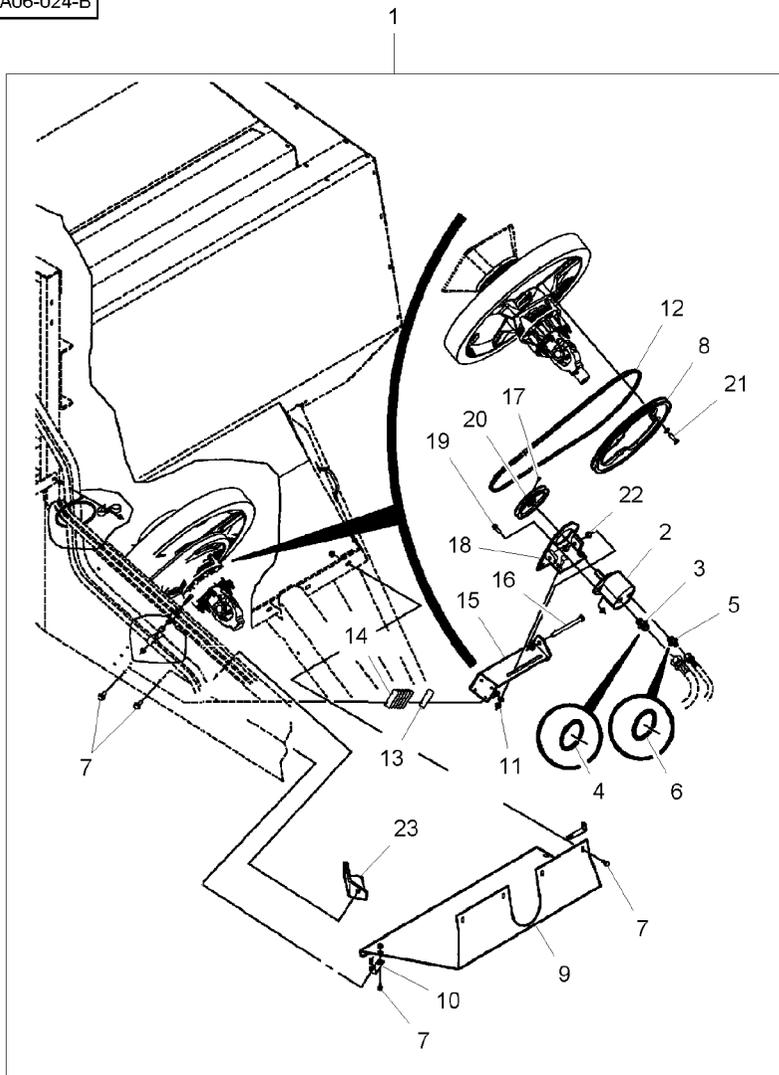

1	☉ 70-55 No 1	1 KIT, ATTACHING	JEU ACCESSOIRE	BEFESTIGUNGSSATZ
2★700717866	1 ➡ HM 91630	1 HYDRAULIC PUMP	KIT ATTACCO	JUEGO DE UNION
2★700722236	☉ 70-65 No 1	1 HYDRAULIC PUMP	POMPEHYDRAULIQUE	HYDROPUMPE
3★70921217	1 ➡ HM 91631	1 HYDRAULIC PUMP	POMPA IDRAULICA	BOMBA HIDRAULICA
4★70921206	☉ 70-65 No 1	1 ADAPTOR	POMPEHYDRAULIQUE	HYDROPUMPE
5★70923717	1	1 O RING	POMPA IDRAULICA	BOMBA HIDRAULICA
6★70921205	3	1 CONNECTOR	ADAPTATEUR	REDUZIERNIPPEL
7★7883382	1	1 O RING	ADATTATORE	ADAPTADOR
7★700711238	3	1 O RING	JOINT TORIQUE	O-RING
8★700149736	1	1 CONNECTOR	ANELLO TENUTA	ANILLO FORMA 'O'
9★700149701P	1	1 O RING	BORNE	DOPELNIPPEL
10★700149702P	5	1 O RING	MORSETTO	CONECTOR
11★70922786	1 3/8"-16 X 1	12 SCREW	JOINT TORIQUE	O-RING
11★Y705533	1 3/8"-16	12 LOCKNUT	ANELLO TENUTA	ANILLO FORMA 'O'
11★700711238	1 3/8"-16	1 PULLEY	VIS	SCHRAUBE
12★700718206	1 3/8"	1 SHIELD	VITE	TORNILLO
13★700718483	1 3/8"-16 X 1	2 SUPPORT	ECROU BLOCAGE	SICHERUNGSMUTTER
14★700718484	1 3/8"	2 BOLT	AUTOBLOCCANTE	CONTRATUERCA
15★700149737P	1 3/8"	2 WASHER	POULIE	RIEMENSCHIEBE
16★873513	1 3/8"	2 LOCKNUT	PULEGGIA	POLEA
16★704056	1 3/8"-16	1 V BELT	TOLE	SCHILD
17★70903835	1 3/8"-16	1 SHIM	RIPARO	BLINDAJE
18★700149726P	1 3/8"-16	6 SHIM	SUPPORT	LAGERUNG
19★7883408	1 1/2"-13 X 6	1 ANGLE.	SUPPORTO	DISPOS.DE SOSTEN
19★700711238	1 1/2"-13	1 CAPSCREW	BOULON	MASCH.SCHRAUBE
20★700149735P	1 1/4"-20 X 3/8	1 NUT	BULLONE	ESPIGA/BULON
	1 1/4"-20 X 3/8	2 SCREW UNC	RONDELLE	UNTERLEGSCHIEBE
	1 1/4"-20 X 3/8	1 SUPPORT	RONDELLA	ARANDELA
	1 3/8"-16 X 1-1/4	2 SCREW	ECROU BLOCAGE	SICHERUNGSMUTTER
	1 3/8"-16	2 LOCKNUT	AUTOBLOCCANTE	CONTRATUERCA
	1	1 PULLEY	COURROIE TRAPEZ.	KEILRIEMEN
			CINGHIA TRAPEZO.	CORREA EN V
			CALE REGLAGE	EINSTELLBLECH
			SPESSORE	CALCE
			CALE REGLAGE	EINSTELLBLECH
			SPESSORE	CALCE
			EQUERRE	WINKEL
			ANGOLO	ANGULO
			VIS BOUCHON	HUTSCHRAUBE
			TAPPO A VITE	TORNILLO TAPON
			ECROU	MUTTER
			DADO	TUERCA
			VIS UNC	SCHRAUBE UNC
			VITE UNC	TORNILLO UNC
			SUPPORT	LAGERUNG
			SUPPORTO	DISPOS.DE SOSTEN
			VIS	SCHRAUBE
			VITE	TORNILLO
			ECROU BLOCAGE	SICHERUNGSMUTTER
			AUTOBLOCCANTE	CONTRATUERCA
			POULIE	RIEMENSCHIEBE
			PULEGGIA	POLEA

Knotter
 Noueur
 Binder
 Legatore
 Anudadora

70-60

Blower Kitit (Continued)
 Jeu Ventilateur (Suite)
 Satz Ventilator (Folge)
 Gioco Ventola (Seguito)
 Juego Ventilador (Sigie)

5-BA06-024-B

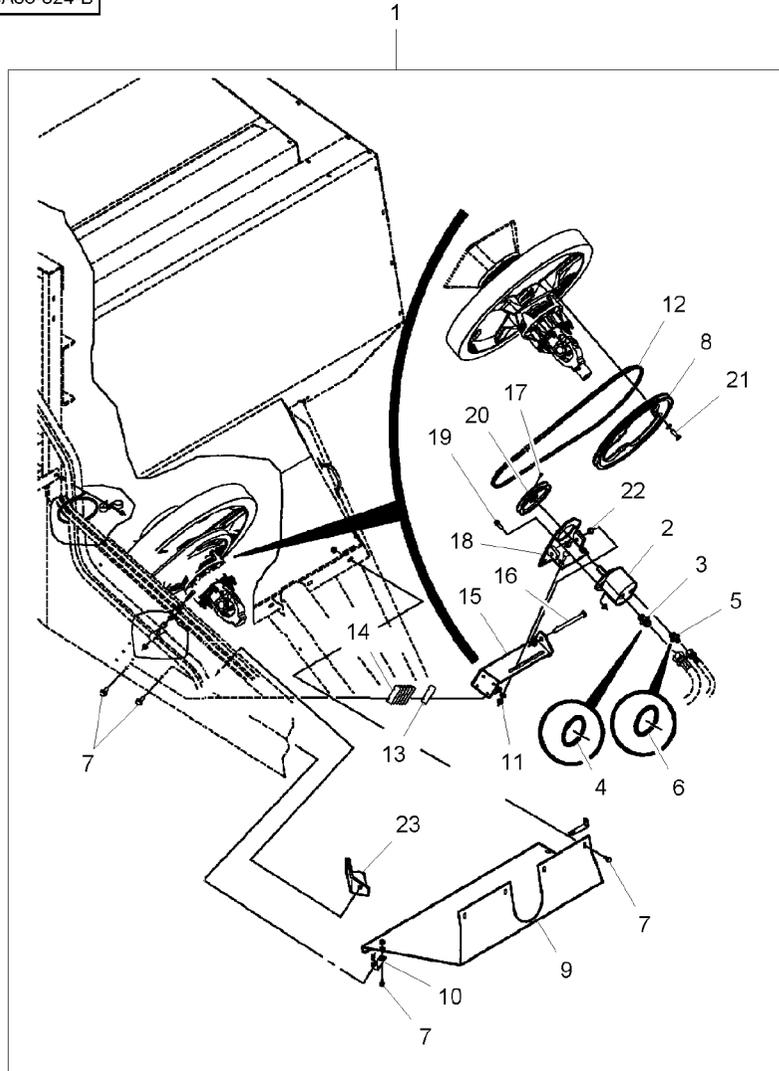

21★701235	1 1/2"-13 X 1-1/2	3 BOLT	BOULON	MASCH.SCHRAUBE
21★Y705046	1 1/2"	3 LOCK WASHER	BULLONE	ESPIGA/BULON
22★704031	1 1/2"-13	2 NUT	RONDELLE FREIN	FEDERRING
23★700149700P	1	1 SUPPORT	ROSETTA DENTELL.	ARANDELA GROWER
			ECROU	MUTTER
			DADO	TUERCA
			SUPPORT	LAGERUNG
			SUPPORTO	DISPOS.DE SOSTEN

Hydraulic Pump
 Pompe Hydraulique
 Hydraulikpumpe
 Pomp Idraulica
 Bomba Hidraulica

70-65

5-BA60-004-A

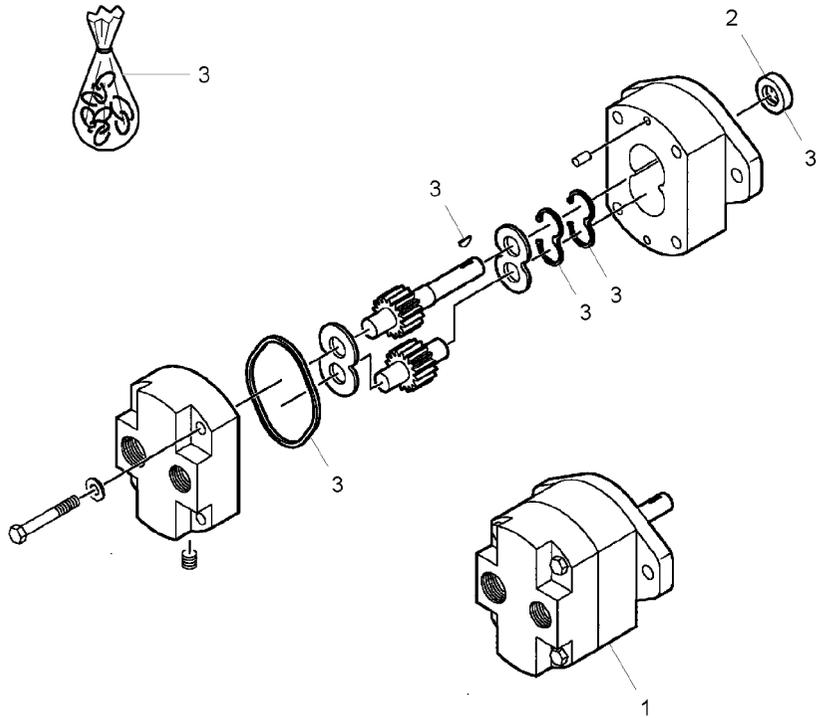

- 1 ★700717866 ➡ HM 91630
- 1 ★700722236 ➡ HM 91631
- 2 ★700718774 ➡ HM 91630
- 3 ★700710949 ➡ HM 91630
- 3 ★700722237 ➡ HM 91631

- 1 HYDRAULIC PUMP
- 1 HYDRAULIC PUMP
- 1 SEAL
- 1 KIT, SEAL
- 1 KIT, SEAL

POMPEHYDRAULIQUE	HYDROPUMPE
POMPA IDRAULICA	BOMBA HIDRAULICA
POMPEHYDRAULIQUE	HYDROPUMPE
POMPA IDRAULICA	BOMBA HIDRAULICA
JOINT ETANCHEITE	DICHTRING
ANELLO RACCORD	ARENDELA D'JUNTA
JEU ETANCHEITE	DICHTRINGSATZ
KIT TENUTA	RETENES JUEGO
JEU ETANCHEITE	DICHTRINGSATZ
KIT TENUTA	RETENES JUEGO

Blower & Oil Tank
 Soufflerie & Reservoir D'Huile
 Geblase & Oeltank
 Soffiatore & Serbatoio Olio
 Ensiladora & Deposito De Aceite

70-70

5-BA53-001-A

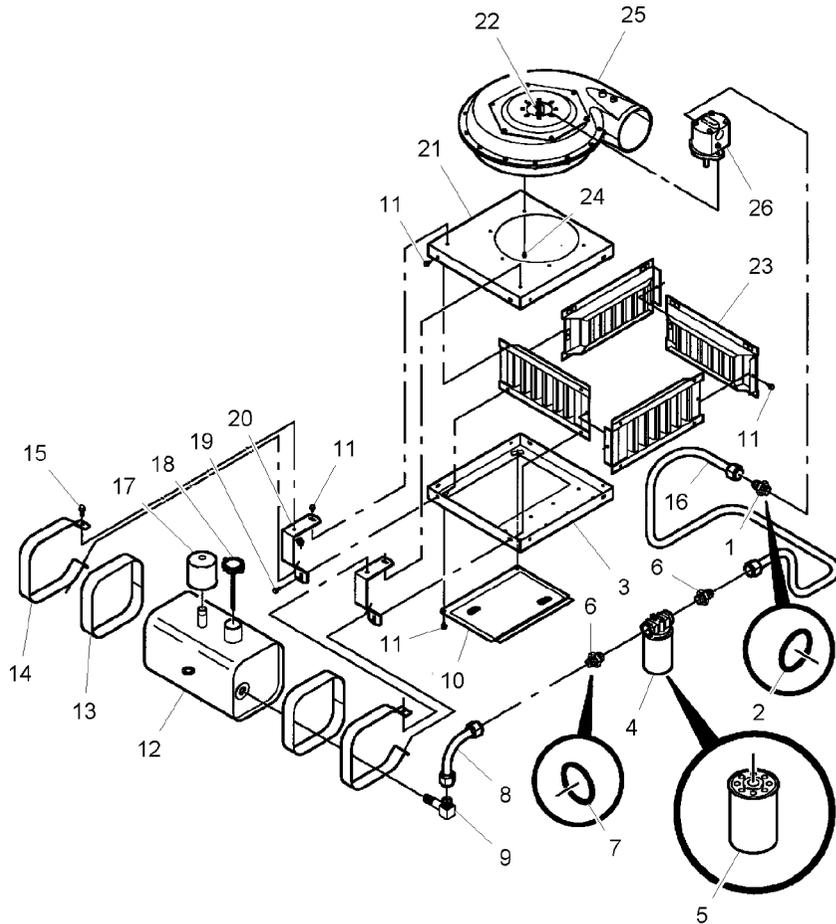

1	★70923174		1	CONNECTOR	BORNE MORSETTO	DOPPELNIPPEL CONECTOR
2	★70921206	1	1	O RING	JOINT TORIQUE ANELLO TENUTA	O-RING ANILLO FORMA 'O'
3	★700149712		1	PANEL	PANNEAU PANNELLO	VERKL.BLECH PANELAJE
4	★700710972		1	KIT, FILTER	JEU FILTRE KIT FILTRO	FILTERSATZ JUEGO FILTRO
5	★7033616	4	1	OIL FILTER	FILTRE HUILE FILTRO OLIO	OELFILTER FILTRO DE ACEITE
6	★70921228		1	ADAPTOR	ADAPTEUR ADATTATORE	REDUZIERNIPPEL ADAPTADOR
7	★70921214	6	1	O RING	JOINT TORIQUE ANELLO TENUTA	O-RING ANILLO FORMA 'O'
8	★700717695		1	TUBE	TUBE TUBO	ROHR TUBO
9	★700717705		1	ELBOW	COUDE GOMITO	WINKELSTUECK CODO
10	★700149714		1	SCREEN	CALANDRE RETICOLO	GITTERSIEB CALANDRA
11	★7883317	5/16"-18 X 1/2	22	SCREW	VIS VITE	SCHRAUBE TORNILLO
12	★700722704		1	OIL TANK	RESERVOIR HUILE SERBATOIO OLIO	OELBEHALTER DEPOSITO ACEITE
13	★844498		2	FELT	FEUTRE FELTRO	FILZ FIELTRO
14	★700149719		2	STRAP	PATTE CORREGGIA	LASCHE FAJA
15	★7883382	3/8"-16 X 1	4	SCREW	VIS VITE	SCHRAUBE TORNILLO
15	★Y704734	3/8"-16	4	LOCKNUT	ECROU BLOCAGE AUTOBLOCCANTE	SICHERUNGSMUTTER CONTRATUERCA
16	★700717696	➡ HP 91215	1	TUBE	TUBE TUBO	ROHR TUBO
16	★700723558	➡ HP 91216	1	TUBE	TUBE TUBO	ROHR TUBO
17	★7825516		1	FILTER	FILTRE FILTRO	FILTER FILTRO
18	★700708076		1	CAP	CHAPEAU CAPUCHON	KAPPE TAPA
19	★7883325	5/16"-18 X 3/4	2	SCREW	VIS VITE	SCHRAUBE TORNILLO
20	★700149718		2	STRAP	PATTE CORREGGIA	LASCHE FAJA
21	★700149710		1	PANEL	PANNEAU PANNELLO	VERKL.BLECH PANELAJE
22	★70923220	3/8"-16 X 1-1/4	2	BOLT	BOULON BULLONE	MASCH.SCHRAUBE ESPIGA/BULON
22	★70919439	3/8"-16	2	NUT	ECROU DADO	MUTTER TUERCA
23	★700149704		4	SCREEN	CALANDRE RETICOLO	GITTERSIEB CALANDRA

Blower & Oil Tank
 Soufflerie & Reservoir D'Huile
 Geblase & Oeltank
 Soffiatore & Serbatoio Olio
 Ensiladora & Deposito De Aceite

70-70

5-BA53-001-A

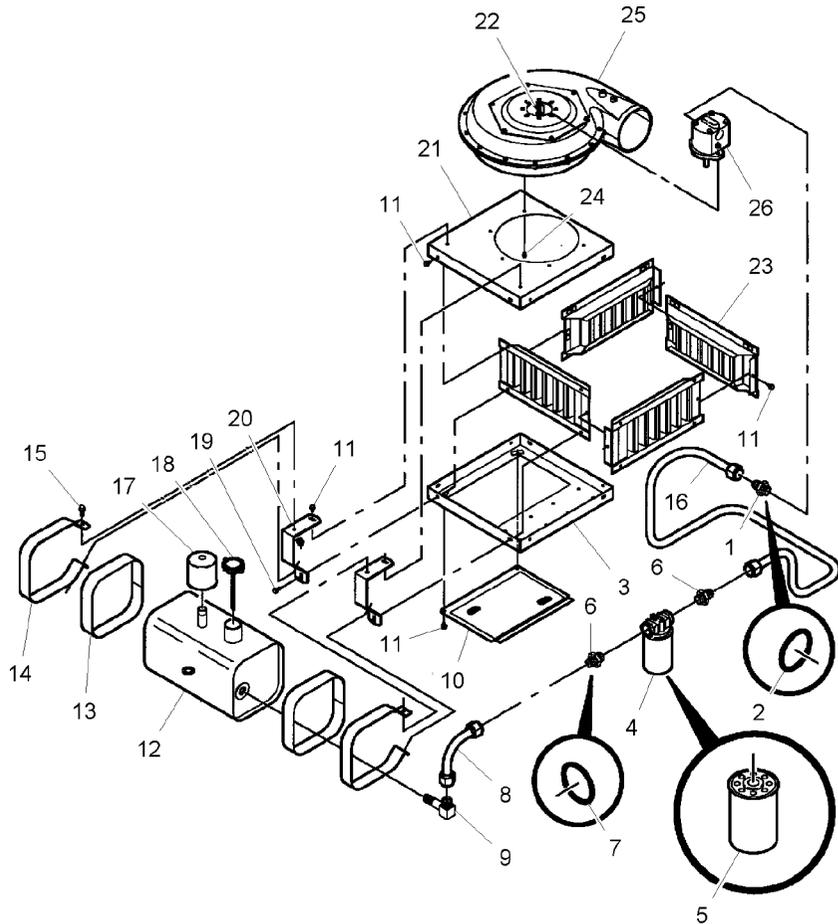

24★7883275

1/4"-20 X 3/4

5 SCREW

VIS
 VITE

SCHRAUBE
 TORNILLO

25★700717713

👁 70-75 No 1

1 BLOWER

SOUFFLERIE
 SOFFIANTE

GEBLAESE
 SOPLETE

26★700717759

➡ HP 91215

1 HYDRAULIC MOTOR

MOTEUR HYDRAULIC
 MOTORE IDRAULICO

HYDROMOTOR
 MOTOR HIDRAULICO

26★700723555

👁 70-80 No 1
 ➡ HP 91216
 👁 70-80 No 1

1 HYDRAULIC MOTOR

MOTEUR HYDRAULIC
 MOTORE IDRAULICO

HYDROMOTOR
 MOTOR HIDRAULICO

Blower
Soufflerie
Geblase
Soffiatore
Ensiladora

70-75

5-BA54-001-A

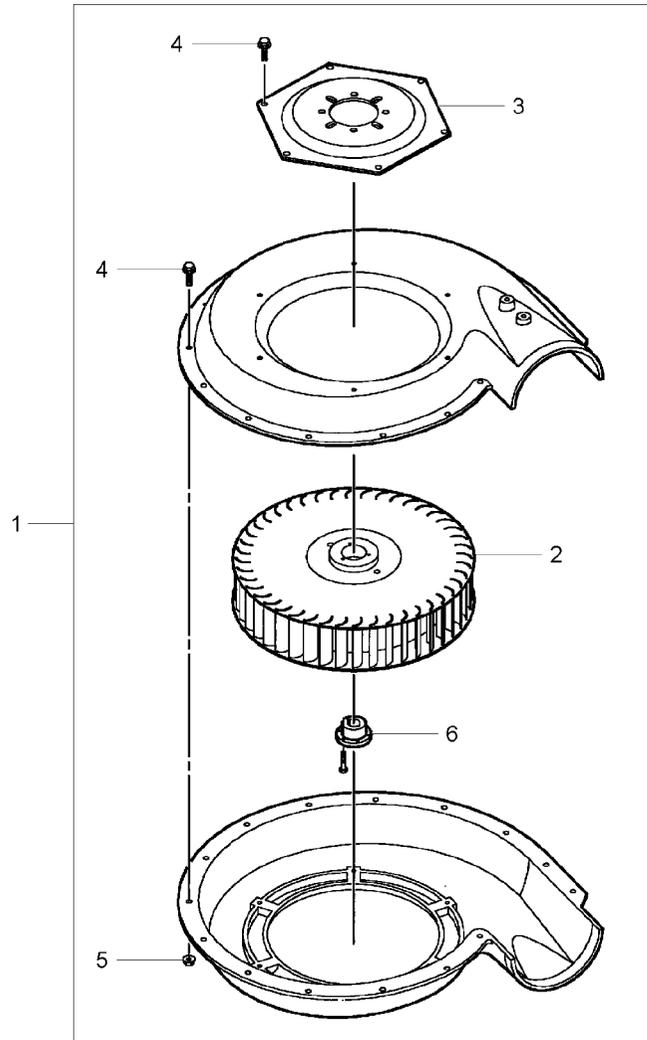

1	★700717713		1	BLOWER	SOUFFLERIE	GEBLAESE
2	★700718702	1	1	FAN	SOFFIANTE	SOPLETE
3	★700718703	1	1	PLATE	VENTILATEUR	LUEFTER
4	★12225	1	1/4"-20 X 1	23 BOLT	VENTOLA	VENTILADOR
5	★70931209	1	1/4"-20	17 NUT	PLAQUE	PLATTE
6	★700718704	1		1 BUSH	PIASTRA	PLATO
					BOULON	MASCH.SCHRAUBE
					BULLONE	ESPIGA/BULON
					ECROU	MUTTER
					DADO	TUERCA
					BAGUE	BUCHSE
					BOCCOLA	CASQUILLO

Hydraulic Motor
 Moteur Hydraulique
 Hydraulikmotor
 Motor Hidraulico
 Motore Idraulico

70-80

5-BA59-002-A

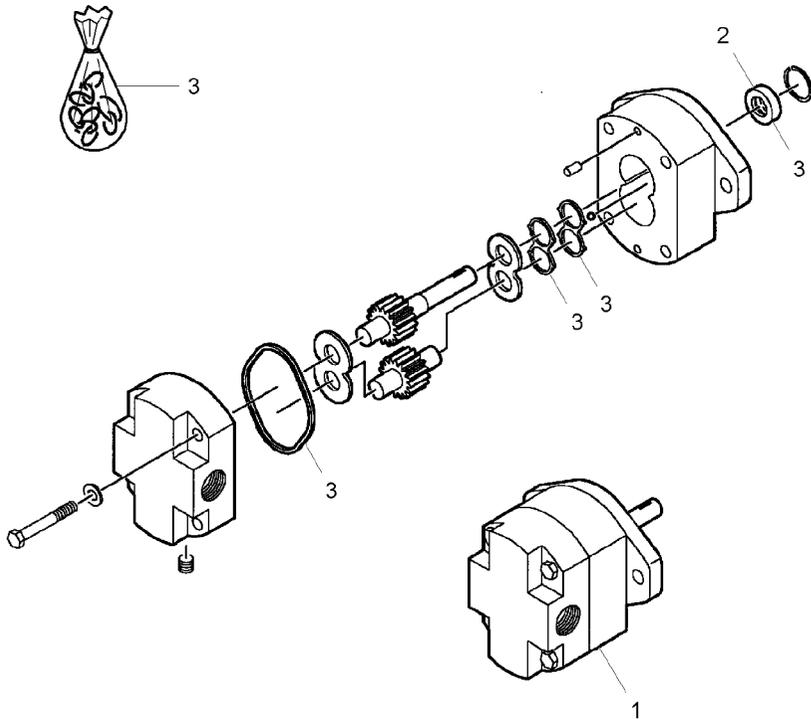

- 1 ★700717759 ➡ HP 91215
- 1 ★700723555 ➡ HP 91216
- 2 ★1713486 ➡ HP 91215
- 2 ★700723562 ➡ HP 91216
- 3 ★7738800 ➡ HP 91215
- 3 ★700723560 ➡ HP 91216

- | | | |
|-------------------|------------------|------------------|
| 1 HYDRAULIC MOTOR | MOTEUR HYDRAULIC | HYDROMOTOR |
| 1 HYDRAULIC MOTOR | MOTORE IDRAULICO | MOTOR HIDRAULICO |
| 1 SEAL | MOTEUR HYDRAULIC | HYDROMOTOR |
| 1 SEAL | MOTORE IDRAULICO | MOTOR HIDRAULICO |
| 1 KIT, JOINT | JOINT ETANCHEITE | DICHTRING |
| 1 KIT, SEAL | ANELLO RACCORD | ARENDELA D'JUNTA |
| | JOINT ETANCHEITE | DICHTRING |
| | ANELLO RACCORD | ARENDELA D'JUNTA |
| | JEU JOINTS | DICHTUNGSSATZ |
| | KIT GIUNTO | JUEGO JUNTAS |
| | JEU ETANCHEITE | DICHTRINGSATZ |
| | KIT TENUTA | RETENES JUEGO |

--	--	--

80

Decals
 Decalcomanies
 Aufkleber
 Decalcomanie
 Callomanias

80-5

5-BA43-004-B

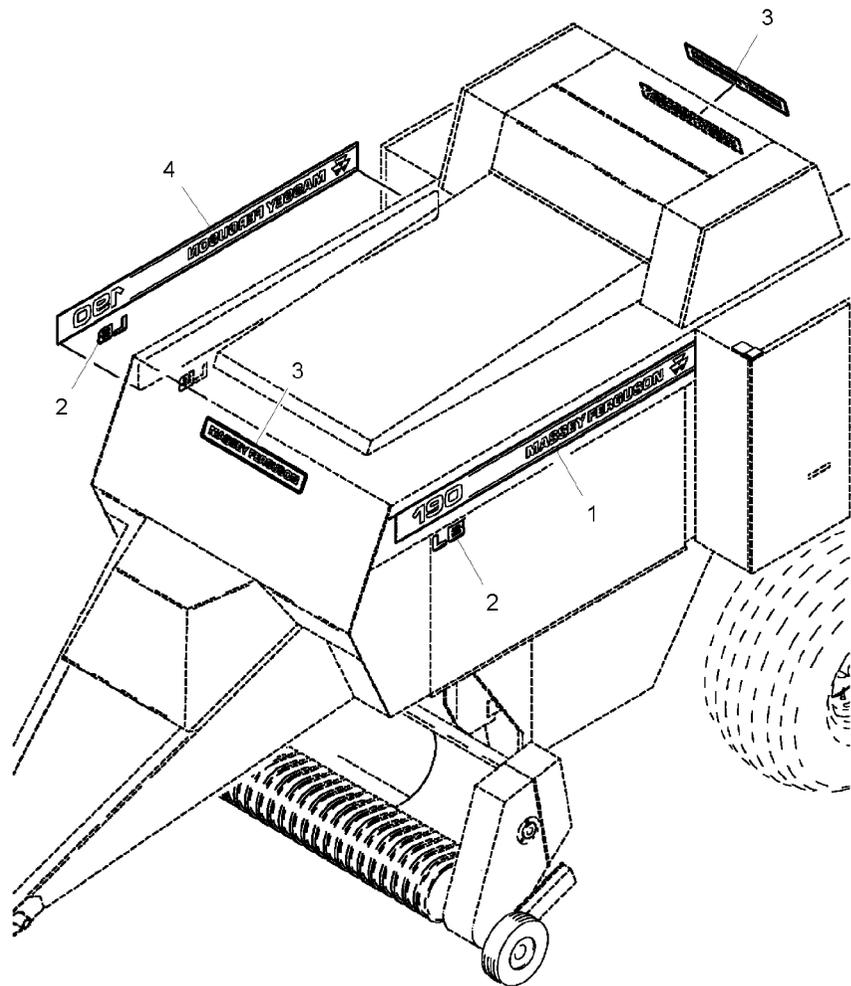

1	700714532	HM 91215	1	DECAL	DECALCOMANIE	AUFKLEBER
1	700720699	HM 91216	1	DECAL	DECALCOMANIA	CALCOMANIA
2	700714545	HM 91215	2	DECAL	DECALCOMANIE	AUFKLEBER
3	700714506	HM 91215	2	DECAL	DECALCOMANIA	CALCOMANIA
4	700714533	HM 91215	1	DECAL	DECALCOMANIE	AUFKLEBER
4	700720700	HM 91216	1	DECAL	DECALCOMANIA	CALCOMANIA

Decals
 Decalcomanies
 Aufkleber
 Decalcomanie
 Callomanias

80-10

➔ 190LB-50100

5-BA43-006-B

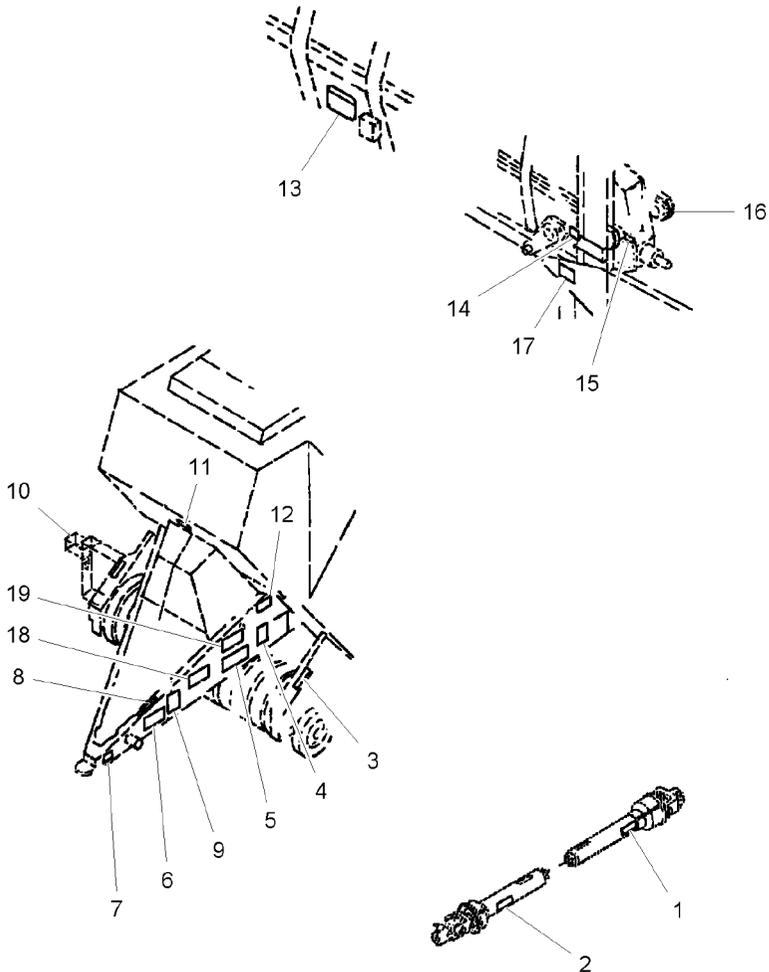

1	700708583	Danger	1	DECAL	DECALCOMANIE	AUFKLEBER
2	700707960		1	DECAL	DECALCOMANIA	CALCOMANIA
3	7778368		2	DECAL	DECALCOMANIA	AUFKLEBER
4	8877789		1	DECAL	DECALCOMANIA	CALCOMANIA
5	700710039		1	DECAL	DECALCOMANIA	AUFKLEBER
6	8877961		1	DECAL	DECALCOMANIA	CALCOMANIA
7	7078264	1000 Rpm	1	DECAL	DECALCOMANIA	AUFKLEBER
8	879197		1	DECAL	DECALCOMANIA	CALCOMANIA
9	700711091		1	DECAL	DECALCOMANIA	AUFKLEBER
10	700706633		1	DECAL	DECALCOMANIA	CALCOMANIA
11	7889348		1	DECAL	DECALCOMANIA	AUFKLEBER
12	8888216		1	DECAL	DECALCOMANIA	AUFKLEBER
13	700710041		1	DECAL	DECALCOMANIA	CALCOMANIA
14	700706856		1	DECAL	DECALCOMANIA	AUFKLEBER
15	700706493		1	DECAL	DECALCOMANIA	CALCOMANIA
16	700706809		2	DECAL	DECALCOMANIA	AUFKLEBER
17	7178973		1	DECAL	DECALCOMANIA	CALCOMANIA
18	3901312M1	[A] Park Brake	1	DECAL	DECALCOMANIA	AUFKLEBER
19	3901313M1	[A] Flywheel Brake	1	DECAL	DECALCOMANIA	CALCOMANIA

[A] EUROPE ONLY
 EUROPE SEULEMENT
 NUR FUER EUROPA
 SOLO EUROPA
 EUROPA SOLAMENTE

Decals
 Decalcomanies
 Aufkleber
 Decalcomanie
 Callomanias

80-15

➔ 190LB-50101

5-BA43-013-E

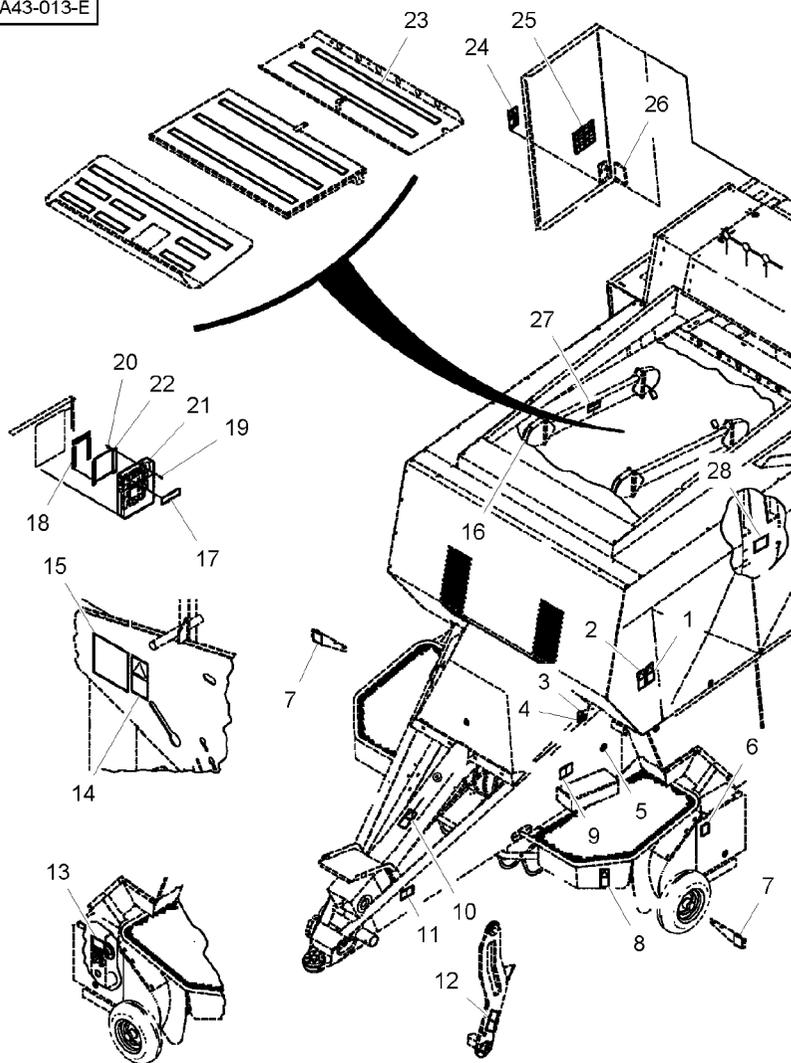

1★700715192	Engine-Off	1 DECAL	DECALCOMANIE	AUFKLEBER
2★700714074	Read Manual	1 DECAL	DECALCOMANIA	CALCOMANIA
3★700709866		1 WASHER	DECALCOMANIA	AUFKLEBER
4★700709867	Slot Camloc	1 DECAL	DECALCOMANIA	CALCOMANIA
5★700714067	CE	1 DECAL	DECALCOMANIA	AUFKLEBER
6★700714661	[B]	2 REFLECTOR	DECALCOMANIA	CALCOMANIA
7★700714660		2 REFLECTOR	CATADIOPTRE	REFLEKTOR
8★700714570	Pickup	2 DECAL	DECALCOMANIA	AUFKLEBER
9★700715154	Brake Flywheel	1 DECAL	DECALCOMANIA	CALCOMANIA
10★700715051	PTO 1000	1 DECAL	DECALCOMANIA	AUFKLEBER
11★700715155	Park Brake	1 DECAL	DECALCOMANIA	CALCOMANIA
12★700720131	Stuffer	1 DECAL	DECALCOMANIA	AUFKLEBER
13★700706633	► Drive	1 DECAL	DECALCOMANIA	CALCOMANIA
14★700714572	Close Shield	1 DECAL	DECALCOMANIA	AUFKLEBER
15★700715159	Stuffer Adjustme	1 DECAL	DECALCOMANIA	CALCOMANIA
16★700706809	Indicator	2 DECAL	DECALCOMANIA	AUFKLEBER
17★700714585	Manual Holder	1 DECAL	DECALCOMANIA	CALCOMANIA
18★700714617		3 TAPE	DECALCOMANIA	AUFKLEBER
19★700705158	1/4"-20 X 1/2	4 SCREW	BANDE MAGNETIQUE	BANDSTREIFEN
20★70931209	1/4"-20	4 NUT	NASTRO MAGNETICO	CINTA
21★700714418		1 HOLDER	VIS	SCHRAUBE
22★700131827B		1 BRACKET	VITE	TORNILLO
23★6849178		1 STRIP	ECROU	MUTTER
24★700715157	Twine Needles	1 DECAL	DADO	TUERCA
25★8888000	► Twine	1 DECAL	PIECE SUPPORT	HALTER
26★700714662	[A]	1 REFLECTOR	SUPPORTO DI BASE	SUJETADOR
			SUPPORT FIXATION	HALTEAM
			STAFFETTA	SOORTE
			RUBAN	STREIFEN
			STRISCIA	TIRA
			DECALCOMANIE	AUFKLEBER
			DECALCOMANIA	CALCOMANIA
			DECALCOMANIA	AUFKLEBER
			DECALCOMANIA	CALCOMANIA
			CATADIOPTRE	REFLEKTOR
			OJO DE GATO	CATADIOPTRICO

Decals
 Decalcomanies
 Aufkleber
 Decalcomanie
 Callomanias

80-15

➔ 190LB-50101

5-BA43-013-E

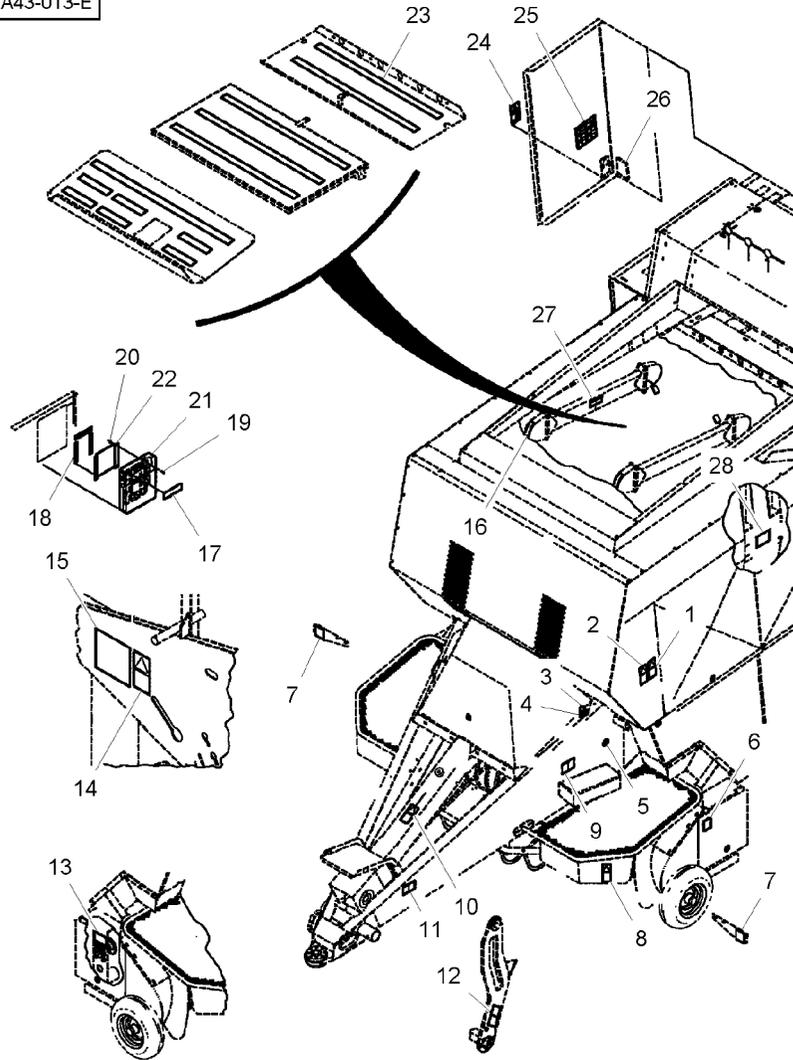

27 ✱ 700725493

Notice

2 DECAL

DECALCOMANIE

AUFKLEBER

28 ✱ 8877334

1 DECAL

DECALCOMANIA

CALCOMANIA

DECALCOMANIE

AUFKLEBER

DECALCOMANIA

CALCOMANIA

[A] RED
 ROUGE
 ROT
 ROSSO
 ROJA

[B] ORANGE
 ORANGE
 ORANGE
 ARANCIONE
 ANARANJADO

Decals
 Decalcomanies
 Aufkleber
 Decalcomanie
 Callomanias

80-20

➔ 190LB-50100

5-BA43-005-B

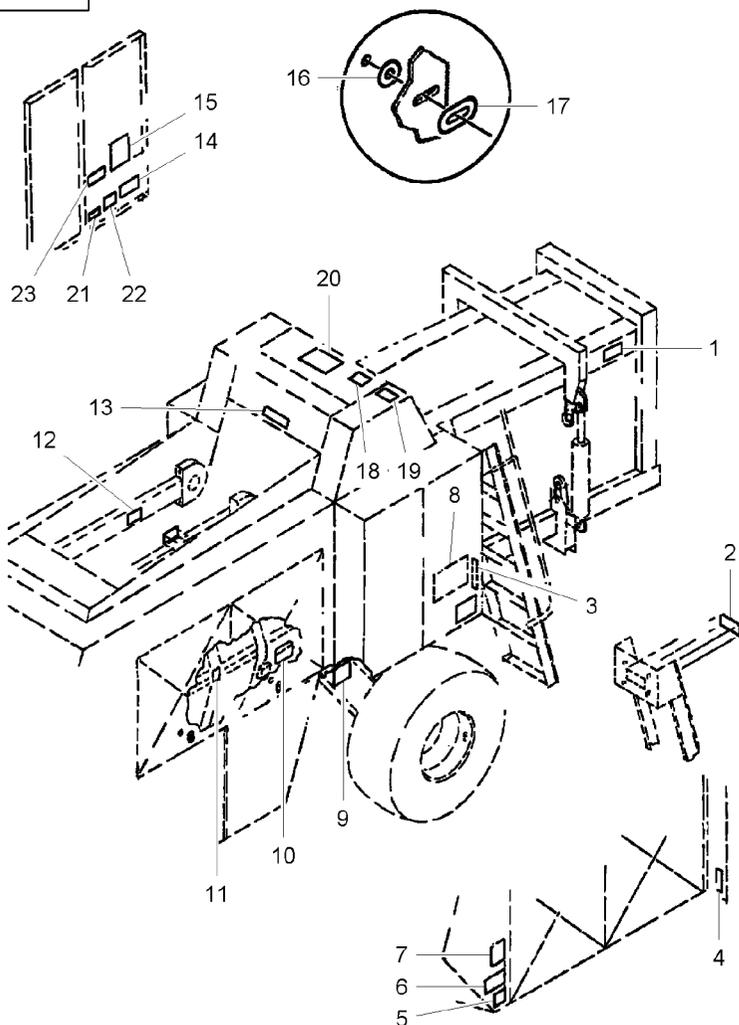

1	8877359	1	DECAL	DECALCOMANIE	AUFKLEBER
2	779199	1	DECAL	DECALCOMANIA	CALCOMANIA
3	878660	1	DECAL	DECALCOMANIE	AUFKLEBER
4	878694	2	REFLECTOR	DECALCOMANIA	CALCOMANIA
5	700714229	2	REFLECTOR	CATADIOPTRE	REFLEKTOR
6	7888175	1	REFLECTOR	OJO DE GATO	CATADIOPTRICO
7	7178999	1	REFLECTOR	CATADIOPTRE	REFLEKTOR
8	8877995	2	DECAL	OJO DE GATO	CATADIOPTRICO
9	700706990	2	DECAL	DECALCOMANIE	AUFKLEBER
10	700710041	2	DECAL	DECALCOMANIA	CALCOMANIA
11	8877334	1	DECAL	DECALCOMANIE	AUFKLEBER
12	700706647	2	DECAL	DECALCOMANIA	CALCOMANIA
13	8888026	1	DECAL	DECALCOMANIE	AUFKLEBER
14	700700036	2	DECAL	DECALCOMANIA	CALCOMANIA
15	8888000	1	DECAL	DECALCOMANIE	AUFKLEBER
16	700709866	19	WASHER	DECALCOMANIA	CALCOMANIA
17	700709867	19	DECAL	DECALCOMANIE	AUFKLEBER
18	8888018	1	DECAL	DECALCOMANIA	CALCOMANIA
19	8877730	1	DECAL	DECALCOMANIE	AUFKLEBER
20	700710040	1	DECAL	DECALCOMANIA	CALCOMANIA
21	7079130	2	DECAL	DECALCOMANIE	AUFKLEBER
22	7877533	2	DECAL	DECALCOMANIA	CALCOMANIA
23	700708190	2	DECAL	DECALCOMANIE	AUFKLEBER
				DECALCOMANIA	CALCOMANIA

TIRE

Decals
 Decalcomanies
 Aufkleber
 Decalcomanie
 Callomanias

80-25

➡ 190LB-50101

5-BA43-014-D

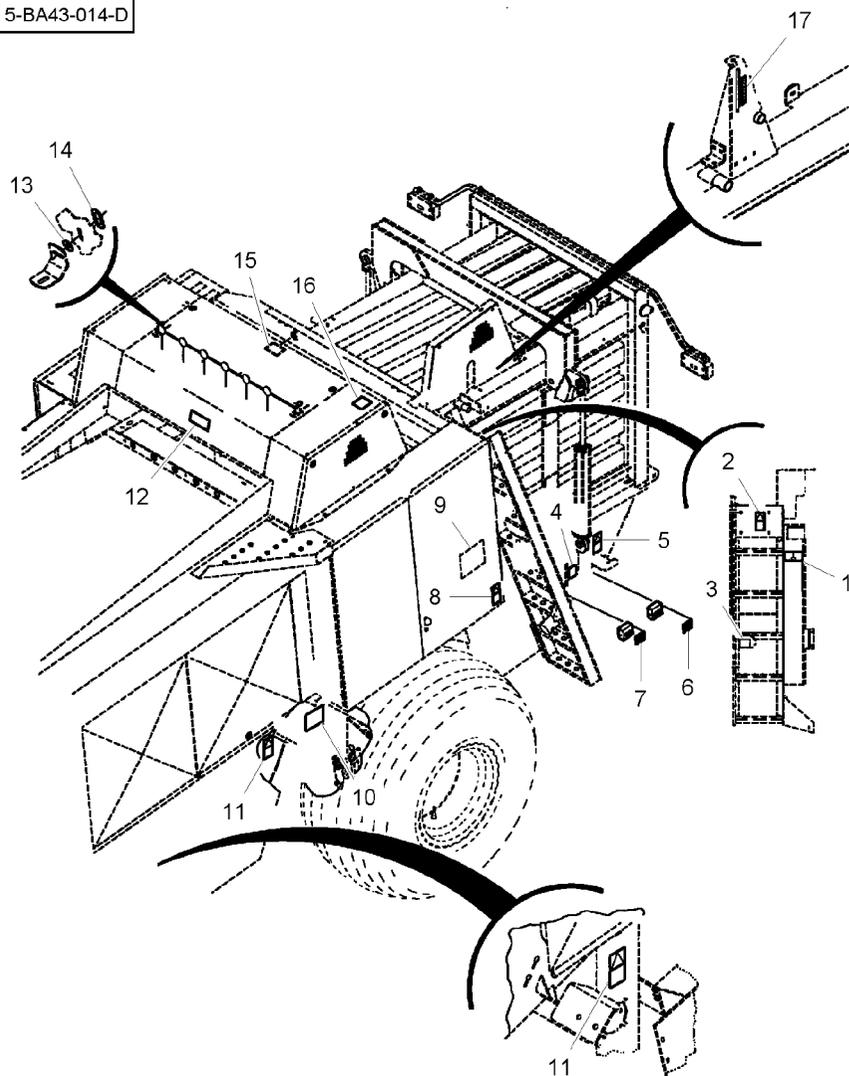

1★700715156	Needle Lock	1 DECAL	DECALCOMANIE	AUFKLEBER
2★700715158	Elec Shock	1 DECAL	DECALCOMANIA	CALCOMANIA
3★700714662	[A]	1 REFLECTOR	DECALCOMANIE	AUFKLEBER
4★700714661	[B]	2 REFLECTOR	DECALCOMANIA	CALCOMANIA
5★700714074	Read Manual	1 DECAL	DECALCOMANIE	AUFKLEBER
6★700726195	Light Switch	1 DECAL	DECALCOMANIA	CALCOMANIA
7★700715153	Lights Switch	1 DECAL	DECALCOMANIE	AUFKLEBER
8★700715157	Twine Needles	1 DECAL	DECALCOMANIA	CALCOMANIA
9★8877995	◀ Twine	1 DECAL	DECALCOMANIE	AUFKLEBER
10★700706990	➡ HM 91616	1 DECAL	DECALCOMANIA	AUFKLEBER
10★700721967	➡ HM 91617	1 DECAL	DECALCOMANIE	CALCOMANIA
11★700714572	Twine Tension	3 DECAL	DECALCOMANIE	AUFKLEBER
12★8888026	Close Shield	1 DECAL	DECALCOMANIA	CALCOMANIA
12★700722006	➡ HM 91616	1 DECAL	DECALCOMANIE	AUFKLEBER
13★700709866	➡ HM 91617	1 DECAL	DECALCOMANIA	CALCOMANIA
14★700709867	2 WASHER	2 DECAL	DECALCOMANIE	RONDELLE
15★8888018	Slot Camloc	2 DECAL	DECALCOMANIA	ARANDELA
15★700721970	➡ HM 91616	1 DECAL	DECALCOMANIE	AUFKLEBER
16★8877730	➡ HM 91617	1 DECAL	DECALCOMANIA	CALCOMANIA
17★700714164	Indicator	1 DECAL	DECALCOMANIE	AUFKLEBER

[A] RED
 ROUGE
 ROT
 ROSSO
 ROJA

[B] ORANGE
 ORANGE
 ORANGE
 ARANCIONE
 ANARANJADO

Accessories And Decals
 Accessoires Et Decalcomanies
 Zubehoer Und Aufkleber
 Accessories E Decalcomanies
 Accesorios Y Callomanies

80-30

Shear Bolt - Kit
 Boulon De Cisaillement - Kit
 Scherbolzen - Kit
 Perno Di Taglio - Kit
 Bulonde Cizallamiento

5-BA12-001-A

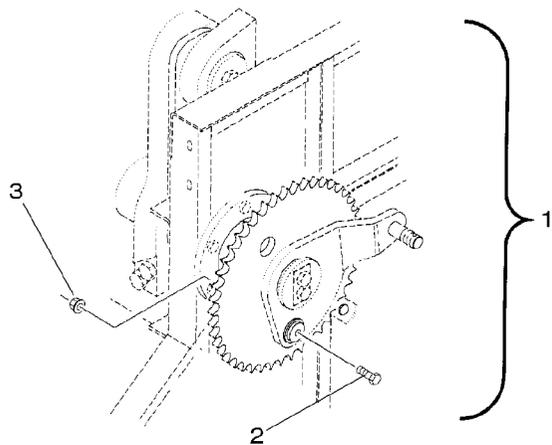
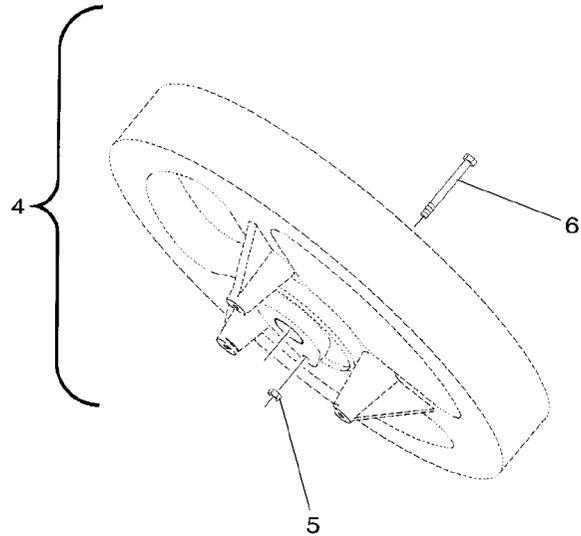

1	700114059		1	KIT, BOLT	JEU BOULONS	SCHRAUBENSATZ
2	70924666	1 1/2"-13 X 2-3/4	10	CAPSCREW	KIT BULLONE	TORNILLOS JUEGO
3	Y704742	1 1/2"-13	10	LOCKNUT	VIS BOUCHON	HUTSCHRAUBE
4	6521868			1	TAPPO A VITE	TORNILLO TAPON
5	★7774995	4 7/16"-14		1	ECROU BLOCAGE	SICHERUNGSMUTTER
6	★7884950	4 7/16"-14 X 2-1/8		1	AUTOBLOCCANTE	CONTRATUERCA
				10	ENSEMBLE BOULON	MASCH.SCHRB.KPL
				10	BULLONE COMPLET	CJT PERNO
					ECROU	MUTTER
					DADO	TUERCA
				10	VIS BOUCHON	HUTSCHRAUBE
					TAPPO A VITE	TORNILLO TAPON

Accessories And Decals
Accessoires Et Decalcomanies
Zubehoer Und Aufkleber
Accessories E Decalcomanies
Accesorios Y Callomanias

80-35

Truss
Barre De Renfort
Trager
Barra Di Renforzo
Barra De Renforzo

5-BA12-004-B

1 700160318

1 KIT

JEU
KIT

SATZ
JUEGO

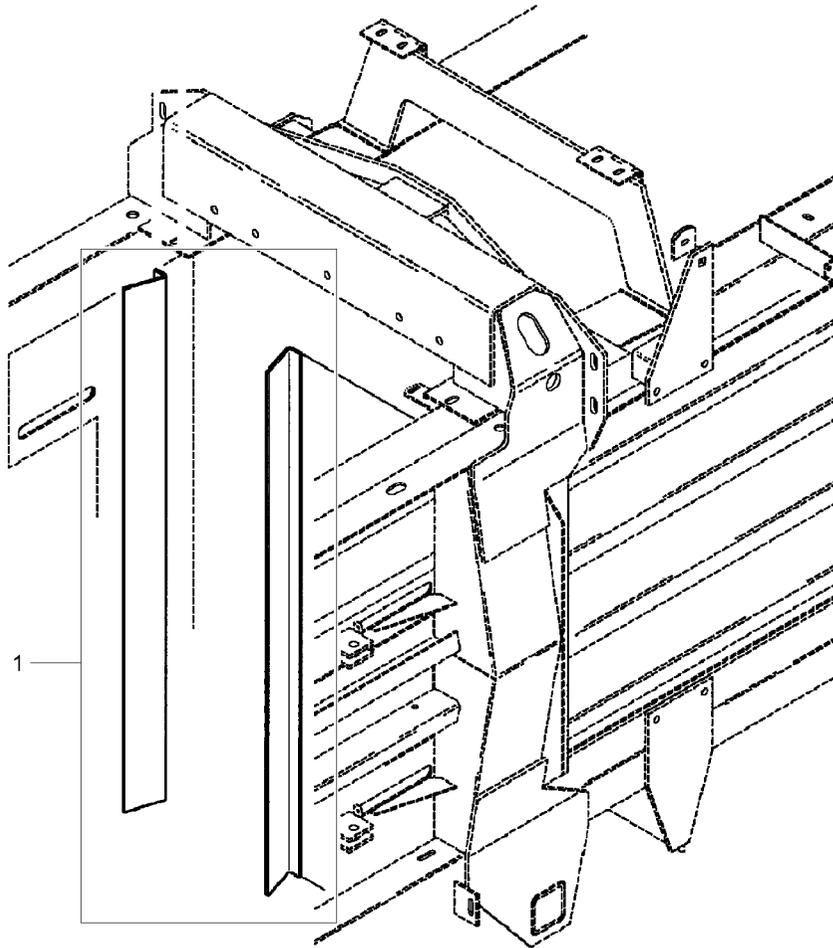

Accessories And Decals
 Accessoires Et Decalcomanies
 Zubehoer Und Aufkleber
 Accessories E Decalcomanies
 Accesorios Y Callomanias

80-40

Kit Slot Cleaner - Up To 190lb-50100
 Kit Grille De Nettoyage - Jusqu Au 190lb-50100
 Kit Gitterreinigung - Bis Den 190lb-50100
 Kit Griglia Di Pulitura - Fino Alla 190lb-50100
 Kit Criba De Limpia - Hasta 190lb-50100

5-BA12-005-A

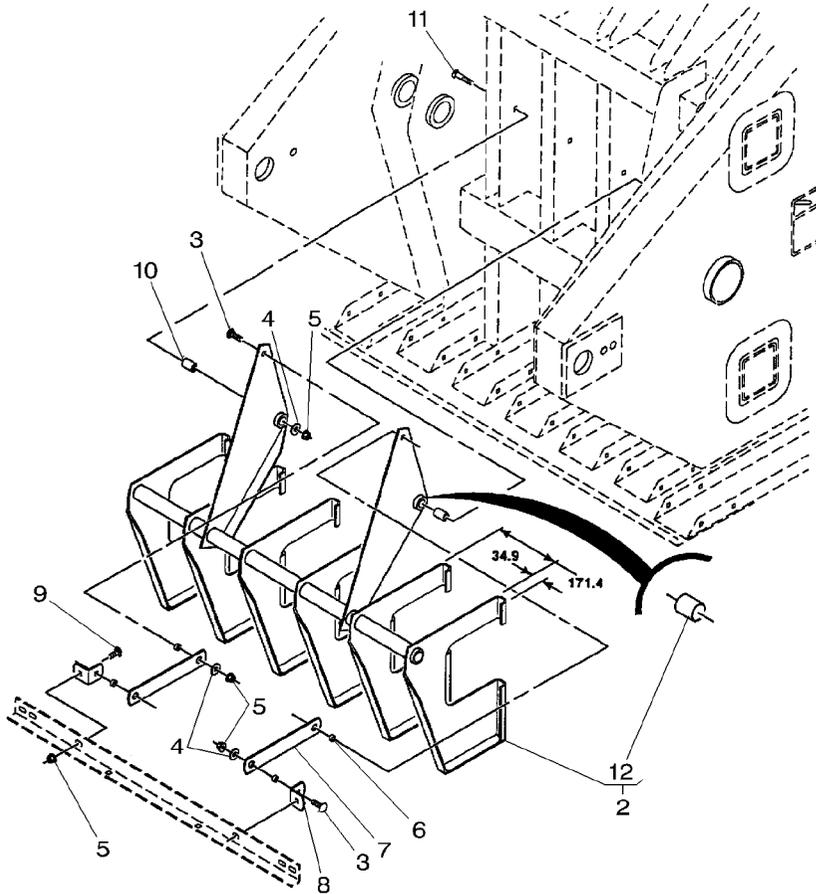

1	700122594	[A]	1	KIT	JEU KIT	SATZ JUEGO
2	700122589	1	1	BLADE	LAME	KLINGE
3	363905X1	1 3/8"-16 X 1-1/4	4	BOLT UNC	LAMA BOULON UNC BULLONE UNC	HOJA CORTANTE MASCH.SCHRB.UNC PERNO UNC
4	355619X1	1 3/8"	6	WASHER	RONDELLE RONDELLA	UNTERLEGSCHIEBE ARANDELA
5	Y704734	1 3/18"-16	8	LOCKNUT	ECROU BLOCAGE AUTOBLOCCANTE	SICHERUNGSMUTTER CONTRATUERCA
6	6232946P	1	4	BUSH	BAGUE BOCCOLA	BUCHSE CASQUILLO
7	700122587P	1	2	STRAP	PATTE CORREGGIA	LASCHE FAJA
8	700122588P	1	2	ANGLE.	EQUERRE ANGOLO	WINKEL ANGULO
9	70922786	1 3/8"-16 X 1	2	BOLT	BOULON BULLONE	MASCH.SCHRAUBE ESPIGA/BULON
10	6518302B	1	2	SPACER	ENTRETOISE DISTANZIALE	ABSTANDSTUECK DISCO ESPACIADOR
11	363906X1	1 3/8"-16 X 2	2	BOLT UNC	BOULON UNC BULLONE UNC	MASCH.SCHRB.UNC PERNO UNC
12	Y740787	1	2	BUSH	BAGUE BOCCOLA	BUCHSE CASQUILLO

[A] NOT ILLUSTRATED
 NON ILLUSTRATE
 NICHT ABGEBILDET
 NO ILLUSTRADO
 NO ILLUSTRATED

Accessories And Decals
 Accessoires Et Decalcomanies
 Zubehoer Und Aufkleber
 Accessories E Decalcomanies
 Accesorios Y Callomanies

80-45

Kit Bale Length Adjustment For Baler - Up To 190lb-50146
 Kit De Reglage De Longueur De Balle Pour Baler - Jusq' Au 190lb-50146
 Einstellungkit Der Hoheheuballen Fuer Baler - Bis 190lb-50146
 Kit Aggiustamento Di Altezza Di Balla Por Baler - Fino Alla 190lb-50146
 Kit Ajuste Del Altura Del Paca Por Baler - Hasta 190lb-50146

5-BA12-007-B

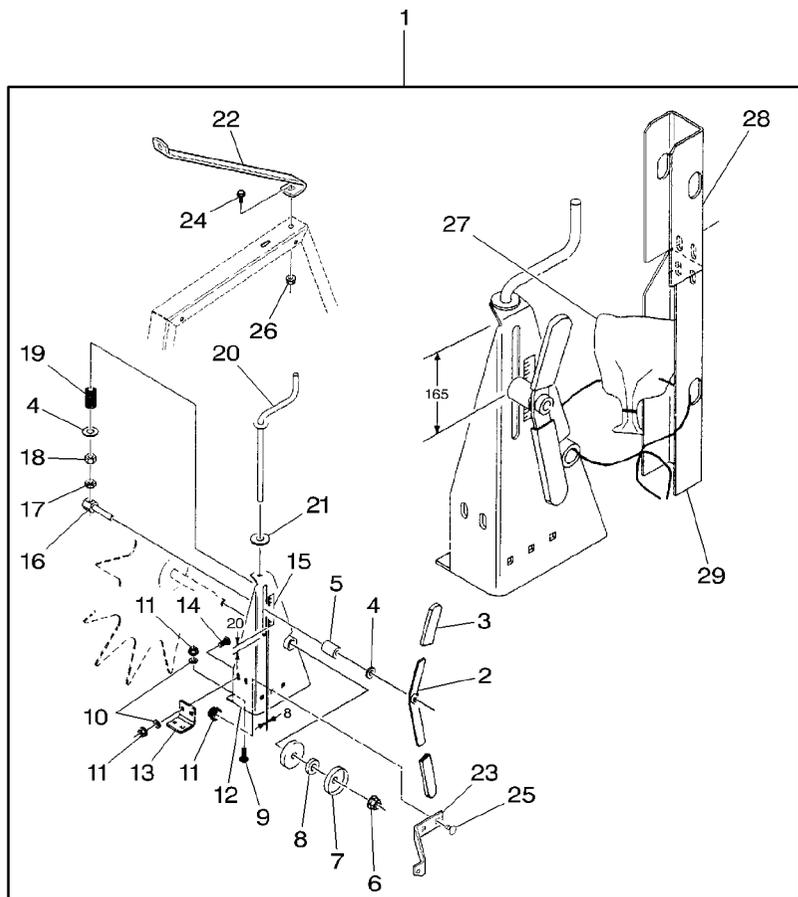

1	700148820		1 KIT	JEU KIT	SATZ JUEGO
2	700134935	1	1 LEVER	LEVIER LEVA	HEBEL PALANCA
3	827360	1	2 GRIP	MANCHE IMPUGNATURA	GRIFF EMPUNADURA
4	705541	1 1/2"	2 WASHER	RONDELLE RONDELLA	UNTERLEGSSCHEIBE ARANDELA
5	6234710	1	1 SPACER	ENTRETOISE DISTANZIALE	ABSTANDSTUECK DISCO ESPACIADOR
6	700703922	1 5/8"-11	1 LOCKNUT	ECROU BLOCCAGE AUTOBLOCCANTE	SICHERUNGSMUTTER CONTRATUERCA
7	700123850P	1	2 SHIELD	TOLE RIPARO	SCHILD BLINDAJE
8	6530489P	1	1 SPACER	ENTRETOISE DISTANZIALE	ABSTANDSTUECK DISCO ESPACIADOR
9	363905X1	1 3/8"-16 X 1-1/4	2 BOLT UNC	BOULON UNC BULLONE UNC	MASCH.SCHRB.UNC PERNO UNC
10	Y705533	1 3/8"	6 WASHER	RONDELLE RONDELLA	UNTERLEGSSCHEIBE ARANDELA
11	700711238	1 3/8"-16	8 LOCKNUT	ECROU BLOCCAGE AUTOBLOCCANTE	SICHERUNGSMUTTER CONTRATUERCA
12	700134931P	1	1 BRACKET	SUPPORT FIXATION STAFFETTA	HALTEAMM SOPORTE
13	700134449P	1	1 ANGLE.	EQUERRE ANGOLO	WINKEL ANGULO
14	70922786	1 3/8"-16 X 1	4 BOLT	BOULON BULLONE	MASCH.SCHRAUBE ESPIGA/BULON
15	700714164	1	1 DECAL	DECALCOMANIE DECALCOMANIA	AUFKLEBER CALCOMANIA
16	700134527	1	1 SHAFT	ARBRE ALBERO	WELLE ARBOL
17	704056	1 1/2"-13	1 NUT	ECROU DADO	MUTTER TUERCA
18	375098X1	1 1/2"-13	1 NUT UNC	ECROU UNC DADO UNC	MUTTER UNC TUERCA UNC
19	58024B	1	1 SPRING	RESSORT MOLLA	FEDER RESORTE
20	700134938	1	1 CRANK	MANIVELLE MANOVELLA	KURBEL MANIVELA
21	700711557	1 1/2"	1 WASHER	RONDELLE RONDELLA	UNTERLEGSSCHEIBE ARANDELA
22	700152228	1	1 ANGLE.	EQUERRE ANGOLO	WINKEL ANGULO
23	700134937P	1	1 SUPPORT	SUPPORT SUPPORTO	LAGERUNG DISPOS.DE SOSTEN
24	7883325	1 5/16"-18 X 3/4	1 SCREW	VIS VITE	SCHRAUBE TORNILLO
25	70922784	1 3/8"-16 X 3/4	2 BOLT	BOULON BULLONE	MASCH.SCHRAUBE ESPIGA/BULON
26	Y704726	1 5/16"-18	1 LOCKNUT	ECROU BLOCCAGE AUTOBLOCCANTE	SICHERUNGSMUTTER CONTRATUERCA

Accessories And Decals
 Accessoires Et Decalcomanies
 Zubehoer Und Aufkleber
 Accessories E Decalcomanies
 Accesorios Y Callomanias

80-45

Kit Bale Length Adjustment For Baler - Up To 190lb-50146
 Kit De Reglage De Longueur De Balle Pour Baler - Jusq'au 190lb-50146
 Einstellungkit Der Hoheheuballen Fuer Baler - Bis 190lb-50146
 Kit Aggiustamento Di Altezza Di Balla Por Baler - Fino Alla 190lb-50146
 Kit Ajuste Del Altura Del Paca Por Baler - Hasta 190lb-50146

5-BA12-007-B

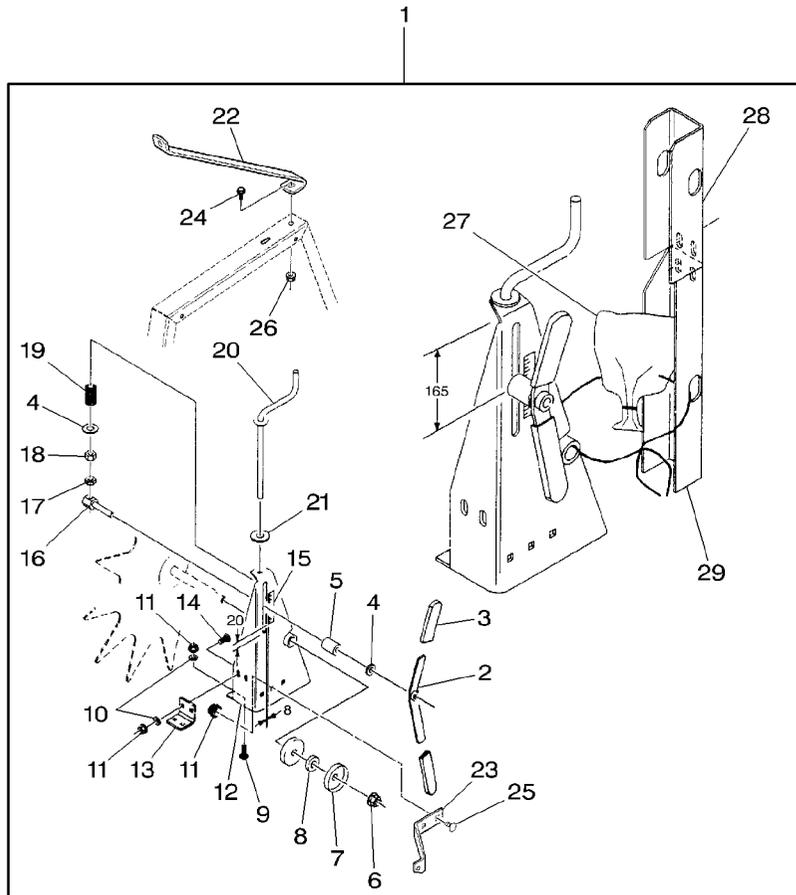

27	[A]	1 BAG	SAC	SACK
			BORSA	BOLSILLO/BOLSA
28	[A]	1 CHANNEL	CANAL	KANAL
			PROFILATO	CANAL
29	[A]	1 CHANNEL	CANAL	KANAL
			PROFILATO	CANAL

[A] NOT SERVICED
 PAS FOURNI
 NICHT LIEFERBAR
 NON FORNITO
 NO SUMINISTRADA

Bale Chute
 Rampe De Dechargement
 Ballenrutsche
 Scivolo Per Balle
 Tobogan De Descarga

80-50

➔ HK 91220

5-BA46-008-B

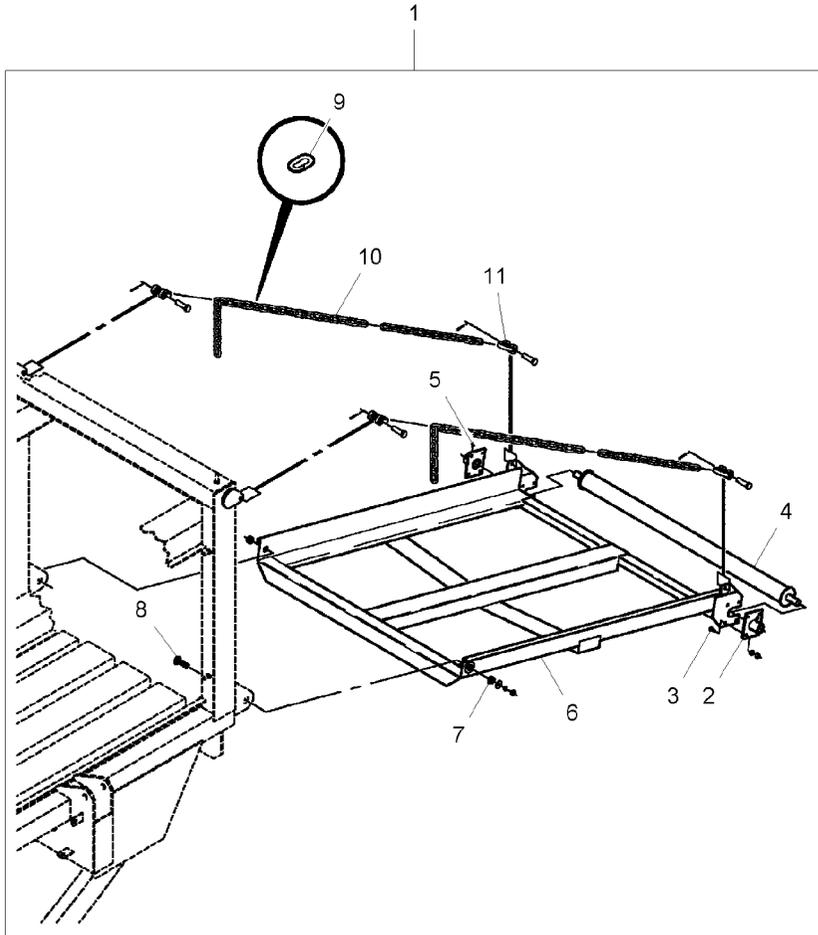

1	★MK42326		1	KIT, ATTACHMENT	JEU ACCESSOIRES	SATZ ANBAUTEILE
2	★6529671P	1		2 BEARING	KIT ACCESSORI	JUEGO ACCESORIO
3	★70922786	1	3/8"-16 X 1	8 BOLT	COUSSINET	LAGER
3	★70916965	1	3/8"	8 LOCK WASHER	CUSCINETTO	COJINETE
3	★70916950	1	3/8"-16	8 NUT	BOULON	MASCH.SCHRAUBE
4	★6529655	1		1 ROLLER	BULLONE	ESPIGA/BULON
5	★70923219	1	1/4"-28	2 GREASER	RONDELLE FREIN	FEDERRING
6	★6529564	1		1 CHUTE	ROSETTA DENTELL.	ARANDELA GROWER
7	★6529705P	1		2 BUSH	ECROU	MUTTER
8	★7870165	1	5/8"-11 X 2	2 CAPSCREW	DADO	TUERCA
8	★70918432	1	5/8"	2 WASHER	GALET	ROLLE
8	★70917373	1	5/8"	2 LOCK WASHER	RULLO	RODILLO
8	★70932665	1	5/8"-11	2 NUT	GRAISSEUR	FETTNIPPEL
9	★87312	1		2 LINK	INGRASSATORE	ENGRASADOR
10	★6529713	1		2 CHAIN	DESCENTE	AUSWURFSCHACHT
11	★Y766113	1		4 CLEVIS	SCARICO	CAIDA
					BAGUE	BUCHSE
					BOCCOLA	CASQUILLO
					VIS BOUCHON	HUTSCHRAUBE
					TAPPO A VITE	TORNILLO TAPON
					RONDELLE	UNTERLEGSCHIBE
					RONDELLA	ARANDELA
					RONDELLE FREIN	FEDERRING
					ROSETTA DENTELL.	ARANDELA GROWER
					ECROU	MUTTER
					DADO	TUERCA
					MAILLON	GLIED
					MAGLIA	ENLACE
					CHAINE	KETTE
					CATENA	CADENA
					CHAPE	GABELSTUECK
					GANCIO D'ATTACCO	GANCHO SEGURI.

Bale Chute
 Rampe De Dechargement
 Ballenrutsche
 Scivolo Per Balle
 Tobogan De Descarga

80-55

➔ HK 91221

5-BA46-022-A

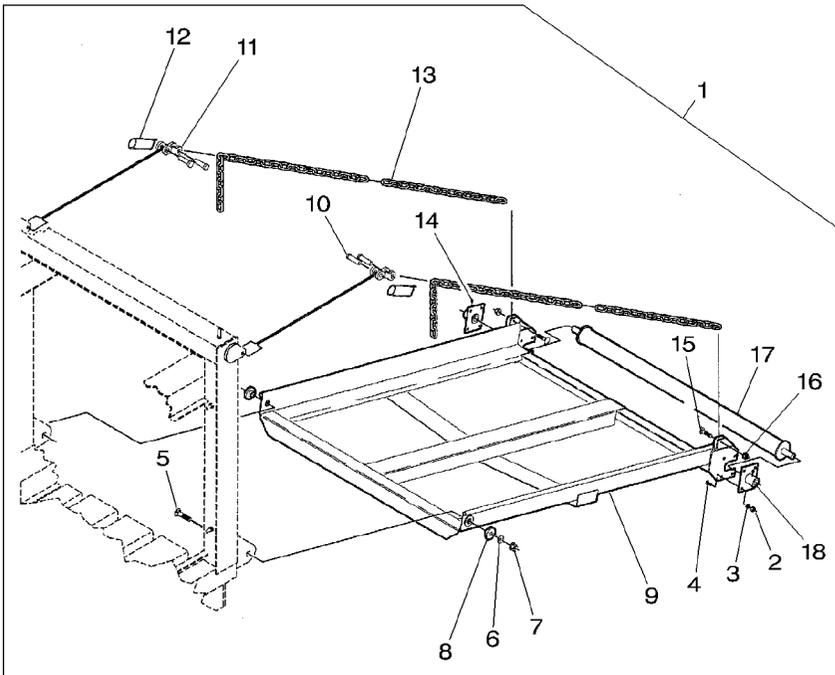

1	MK41084		1	KIT, BALE	JEU BALLE	BALLENPR.SATZ
2	70922786	1 3/8"-16 X 1	8	BOLT	KIT IMBALLAGGIO	JUEGO PARA BALAS
3	★70916965	1 3/8"	8	LOCK WASHER	BOULON	MASCH.SCHRAUBE
4	★70916950	1 3/8"-16	8	NUT	BULLONE	ESPIGA/BULON
5	70933955	1 5/8"-11 X 2-3/4	2	BOLT	RONDELLE FREIN	FEDERRING
6	700711165	1 5/8"	2	WASHER	ROSETTA DENTELL.	ARANDELA GROWER
7	700703922	1 5/8"-11	2	LOCKNUT	ECROU	MUTTER
8	★700153603	1	2	BUSH	DADO	TUERCA
9	★700139232	1	2	CHUTE	BOULON	MASCH.SCHRAUBE
10	Y766113	1	2	CLEVIS	BULLONE	ESPIGA/BULON
11	700714053	1	2	LINK	RONDELLE	UNTERLEGSCHIEBE
12	700714066	1	2	PIN	RONDELLA	ARANDELA
13	700714047	1	2	CHAIN	ECROU BLOCAGE	SICHERUNGSMUTTER
14	70923219	1 1/4"-28	2	GREASER	AUTOBLOCCANTE	CONTRATUERCA
15	★70919089	1 1/2"-13 X 2	2	CAPSCREW	BAGUE	BUCHSE
16	Y704742	1 1/2"-13	2	LOCKNUT	BOCCOLA	CASQUILLO
17	★700153598	1	1	ROLLER	DESCENTE	AUSWURFSCHACHT
18	★6529671P	1	2	BEARING	SCARICO	CAIDA
					CHAPE	GABELSTUECK
					GANCIO D'ATTACCO	GANCHO SEGUR.
					MAILLON	GLIED
					MAGLIA	ENLACE
					GOUVILLE	BOLZEN
					PERNO	PASADOR
					CHAINE	KETTE
					CATENA	CADENA
					GRAISSEUR	FETTNIPPEL
					INGRASSATORE	ENGRASADOR
					VIS BOUCHON	HUTSCHRAUBE
					TAPPO A VITE	TORNILLO TAPON
					ECROU BLOCAGE	SICHERUNGSMUTTER
					AUTOBLOCCANTE	CONTRATUERCA
					GALET	ROLLE
					RULLO	RODILLO
					COUSSINET	LAGER
					CUSCINETTO	COJINETE

Connector Assembly Kit
 Jeu D'Accouplement
 Satz Kupplungsstueck
 Kit Raccordi
 Juego De Conjunto De Conector

80-60

5-1586-001-A

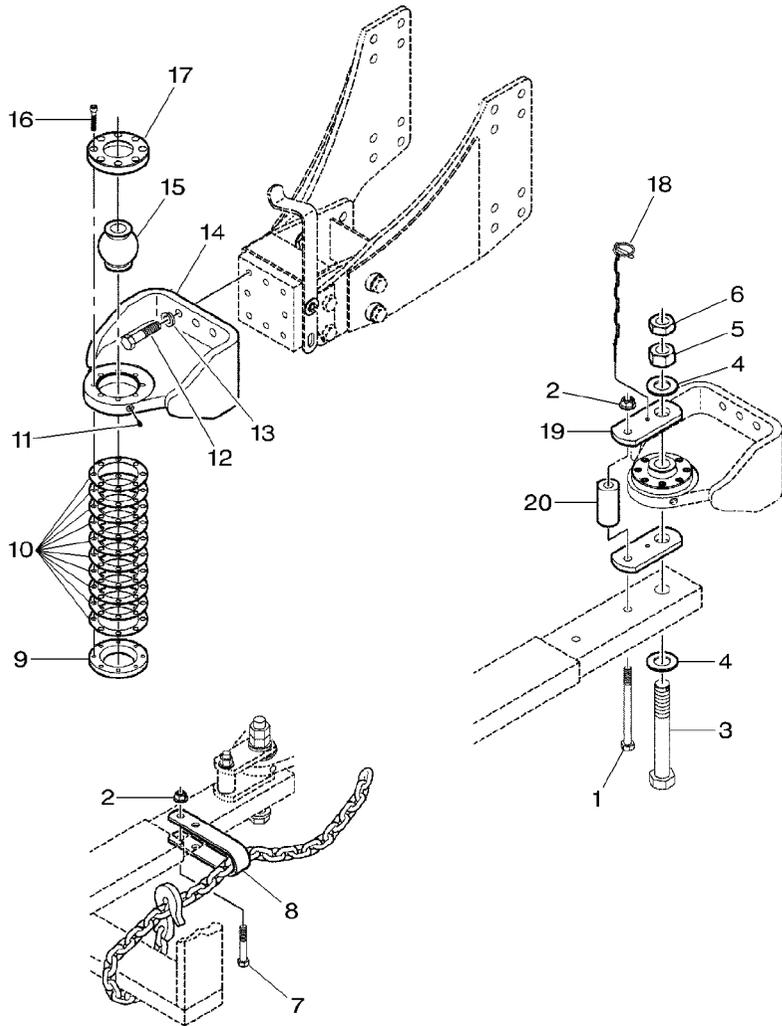

0	★MK41151		1 KIT, ATTACHMENT	JEU ACCESSOIRES KIT ACCESSORI	SATZ ANBAUTEILE JUEGO ACCESORIO
1	700716624	5/8"-11 X 7-1/2	1 BOLT	BOULON BULLONE	MASCH.SCHRAUBE ESPIGA/BULON
2	★700703922	5/8"-11	2 LOCKNUT	ECROU BLOCAGE AUTOBLOCCANTE	SICHERUNGSMUTTER CONTRATUERCA
3	700124041		1 BOLT	BOULON BULLONE	MASCH.SCHRAUBE ESPIGA/BULON
4	7705197	1"-1/4	2 WASHER	RONDELLE RONDELLA	UNTERLEGSCHIEBE ARANDELA
5	★7704653	1"-1/4-7	1 NUT	ECROU DADO	MUTTER TUERCA
6	704585	1"-1/4-7	1 NUT	ECROU DADO	MUTTER TUERCA
7	★70923501	5/8"-11 X 3-3/4	1 CAPSCREW	VIS BOUCHON TAPPO A VITE	HUTSCHRAUBE TORNILLO TAPON
8	700113646B		1 CLEVIS	CHAPE GANCIO D'ATTACCO	GABELSTUECK GANCHO SEGUR.
9	1663158P		1 RING	ANNEAU ANELLO	RING ARO
10	1663163		10 SHIM	CALE REGLAGE SPessore	EINSTELLBLECH CALCE
11	★70923219	1/4"-28	1 GREASER	GRAISSEUR INGRASSATORE	FETTNIPPEL ENGRASADOR
12	7703879	M16 X 60	6 CAPSCREW	VIS BOUCHON TAPPO A VITE	HUTSCHRAUBE TORNILLO TAPON
13	700708348	M16	6 LOCKNUT	ECROU BLOCAGE AUTOBLOCCANTE	SICHERUNGSMUTTER CONTRATUERCA
14	★700164420		1 HITCH	ATTELAGE ATTACCO	ANHAENGEKUPPLUNG ENGANCHE
15	1663159P		1 BALL	BILLE SFERA	KUGEL BOLA
16	70912269	3/8"-16 X 2	8 CAPSCREW	VIS BOUCHON TAPPO A VITE	HUTSCHRAUBE TORNILLO TAPON
17	1663157P		1 RING	ANNEAU ANELLO	RING ARO
18	Y762260		1 PIN	GOUPILLE PERNO	BOLZEN PASADOR
19	★1663161B		2 PLATE	PLAQUE PIASTRA	PLATTE PLATO
20	★1663162B		1 SPACER	ENTRETOISE Distanziale	ABSTANDSTUECK DISCO ESPACIADOR

Transmission
Transmission
Getriebe
Transmissione
Transmission

80-65

Kit Asae Type 2 - Up To 190lb-50100
Kit Asae Type 2 - Jusqu'au 190lb-50100
Kit Asae Type 2 - Bis 190lb-50100
Kit Asae Type 2 - Fino Alla 190lb-50100
Kit Asae Type 2 - Hasta 190lb-50100

5-BA01-013-B

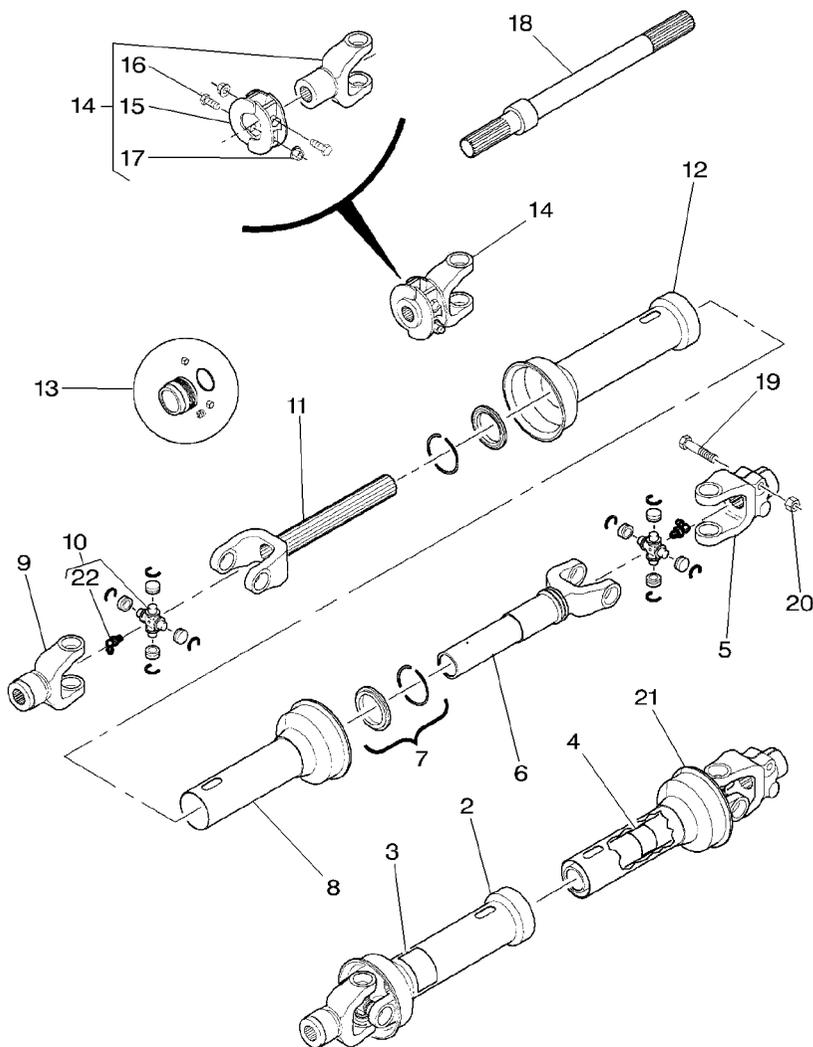

1	MK60551	[A]	1	KIT	JEU KIT	SATZ JUEGO
2	700712444	1	1	UNIVERSAL JOINT	CARDAN GIUNTO UNIVERSAL	KARDANGELENK JUNTA UNIVERSAL
3	700707960	1	1	DECAL	DECALCOMANIE DECALCOMANIA	AUFKLEBER CALCOMANIA
4	★700708583	1	1	Danger	DECALCOMANIE DECALCOMANIA	AUFKLEBER CALCOMANIA
5	700712517	1	1	YOKE	CHAPE ARTICULAT FORCELLA	GELENKGABEL YUGO
6	700712445	1	1	YOKE	CHAPE ARTICULAT FORCELLA	GELENKGABEL YUGO
7	700712579	1	2	KIT, SERVICE	KIT SERVICE KIT DI SERVIZIO	WARTUNGSSATZ JEUGO, SERVICE
8	700712446	1	1	SHIELD	TOLE RIPARO	SCHILD BLINDAJE
9	8802548	1	1	YOKE	CHAPE ARTICULAT FORCELLA	GELENKGABEL YUGO
10	7815053	1	2	KIT, REPAIR	JEU REPARATION KIT RIPARAZIONE	REPARATURSATZ JUEGO REPARACION
11	700706966	1	1	YOKE	CHAPE ARTICULAT FORCELLA	GELENKGABEL YUGO
12	700712447	1	1	SHIELD	TOLE RIPARO	SCHILD BLINDAJE
13	★700710928	1	1	KIT, REPAIR	JEU REPARATION KIT RIPARAZIONE	REPARATURSATZ JUEGO REPARACION
14	700712474	1	1	YOKE	CHAPE ARTICULAT FORCELLA	GELENKGABEL YUGO
15	700712475	1	1	CLAMP	COLLIER FASCETTA	HALTESCHELLE ABRAZADERA
16	354655X1	1	2	BOLT UNC	BOULON UNC BULLONE UNC	MASCH.SCHRB.UNC PERNO UNC
17	704858	1	2	LOCKNUT	ECROU BLOCAGE AUTOBLOCCANTE	SICHERUNGSMUTTER CONTRATUERCA
18	700113039P	1	1	SHAFT	ARBRE ALBERO	WELLE ARBOL
19	354289X1	1	1	BOLT UNC	BOULON UNC BULLONE UNC	MASCH.SCHRB.UNC PERNO UNC
20	70926937	1	1	NUT	ECROU DADO	MUTTER TUERCA
21	700712443	1	1	UNIVERSAL JOINT	CARDAN GIUNTO UNIVERSAL	KARDANGELENK JUNTA UNIVERSAL
22	13223X	10	2	NIPPLE	GRAISSEUR COUDE NIPPLO	NIPPEL NIPLE

[A] NOT ILLUSTRATED
NON ILLUSTRE
NICHT ABGEBILDET
NO ILLUSTRADO
NO ILLUSTRATED

Transmission
 Transmission
 Getriebe
 Transmissions
 Transmission

80-70

Kit Asae Type 3 - Up To 190lb-50100
 Kit Asae Type 3 - Jusqu'au 190lb-50100
 Kit Asae Type 3 - Bis 190lb-50100
 Kit Asae Type 3 - Fino Alla 190lb-50100
 Kit Asae Type 3 - Hasta 190lb-50100

5-BA01-014-B

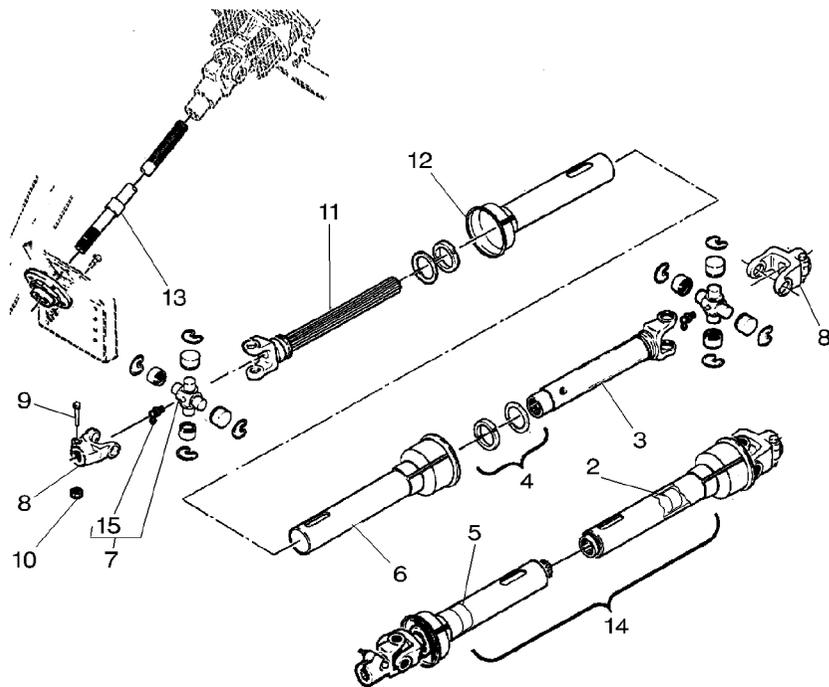

1	MK40425	[A]	1	KIT	JEU KIT	SATZ JUEGO
2	★700708583	14	1	DECAL	DECALCOMANIE DECALCOMANIA	AUFKLEBER CALCOMANIA
3	8802621	14	1	YOKE	CHAPE ARTICULAT FORCELLA	GELENKGABEL YUGO
4	700712579	14	2	KIT, SERVICE	KIT SERVICE KIT DI SERVIZIO	WARTUNGSSATZ JEUO.SERVICE
5	700707960	14	1	DECAL	DECALCOMANIE DECALCOMANIA	AUFKLEBER CALCOMANIA
6	700706953	14	1	SHIELD	TOLE RIPARO	SCHILD BLINDAJE
7	7815053	14	2	KIT, REPAIR	JEU REPARATION KIT RIPARAZIONE	REPARATURSATZ JUEGO REPARACION
8	700712517	1	2	YOKE	CHAPE ARTICULAT FORCELLA	GELENKGABEL YUGO
9	354289X1	1	2	BOLT UNC	BOULON UNC BULLONE UNC	MASCH.SCHRB.UNC PERNO UNC
10	70926937	1	2	NUT	ECROU DADO	MUTTER TUERCA
11	8802613	14	1	SHAFT	ARBRE ALBERO	WELLE ARBOL
12	700706954	14	1	SHIELD	TOLE RIPARO	SCHILD BLINDAJE
13	700113634P	1	1	SHAFT	ARBRE ALBERO	WELLE ARBOL
14	★700720062	1	1	UNIVERSAL JOINT	CARDAN GIUNTO UNIVERSAL	KARDANGELENK JUNTA UNIVERSAL
15	13223X	7	2	NIPPLE	GRAISSEUR COUDE NIPPLIO	NIPPEL NIPLE

[A] NOT ILLUSTRATED
 NON ILLUSTRATE
 NICHT ABGEBILDET
 NO ILLUSTRADO
 NO ILLUSTRATED

Transmission
 Transmission
 Getriebe
 Transmissions
 Transmission

80-75

Type 3 1-3/4 X 20 - From 190lb-50101
 Type 3 1-3/4 X 20 - A Partir Du 190lb-50101
 Type 3 1-3/4 X 20 - Ab Den 190lb-50101
 Type 3 1-3/4 X 20 - Dalla 190lb-50101
 Type 3 1-3/4 X 20 - A Partir Del 190lb-50101

5-BA01-027-B

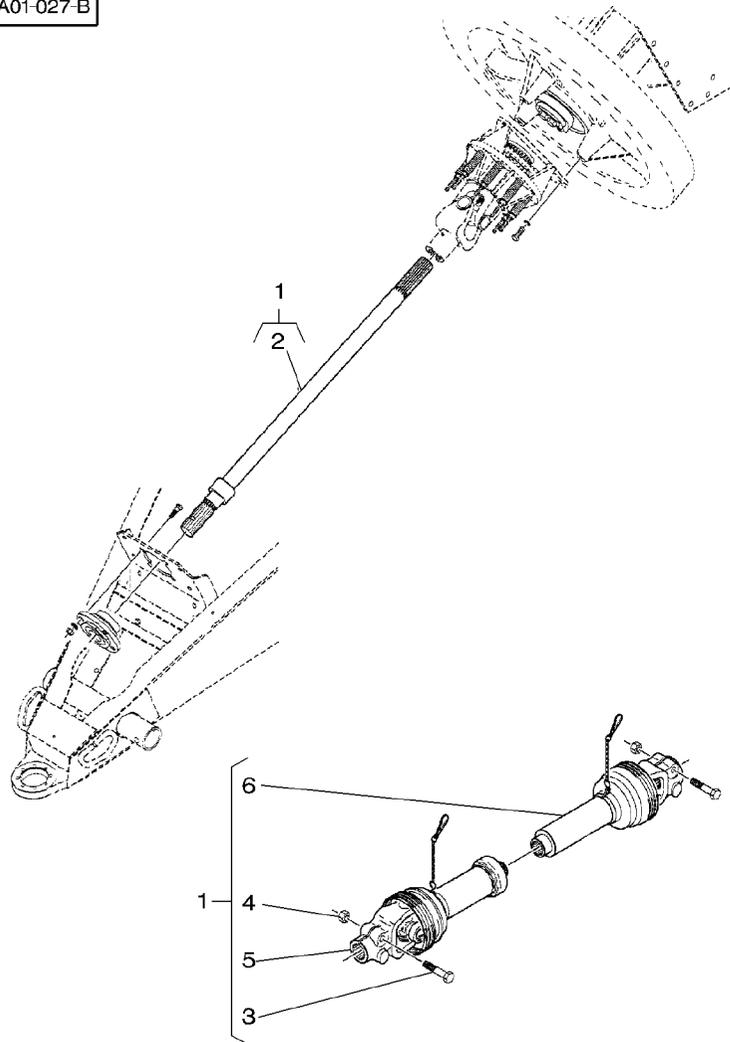

1	★MK40906		1	KIT, ATTACHMENT	JEU ACCESSOIRES	SATZ ANBAUTEILE
1	★MK41116	[A]	1	KIT, ATTACHMENT	KIT ACCESSORI	JUEGO ACCESORIO
2	700113634P	1	1	SHAFT	JEU ACCESSOIRES	SATZ ANBAUTEILE
2	★700153507P	1 [A]	1	SHAFT	KIT ACCESSORI	JUEGO ACCESORIO
3	★700708270	1 5/8"-11 X 3	2	CAPSCREW	ARBRE	WELLE
3	★700708270	1 [A]	1	SHAFT	ALBERO	ARBOL
4	700711198	1 5/8"-11	2	CAPSCREW	ARBRE	WELLE
5	700720111	1 [B]	2	CAPSCREW	ALBERO	ARBOL
6	★700715824	1 [C]	2	CAPSCREW	VIS BOUCHON	HUTSCHRAUBE
		☉ 10-35 No 2	2	CAPSCREW	TAPPO A VITE	TORNILLO TAPON
		☉ 10-35 No 1	2	LOCKNUT	VIS BOUCHON	HUTSCHRAUBE
			1	UNIVERSAL JOINT	TAPPO A VITE	TORNILLO TAPON
			1	UNIVERSAL JOINT	ECROU BLOCAGE	SICHERUNGSMUTTER
					AUTOBLOCCANTE	CONTRATUERCA
					CARDAN	KARDANGELN
					GIUNTO UNIVERSAL	JUNTA UNIVERSAL
					CARDAN	KARDANGELN
					GIUNTO UNIVERSAL	JUNTA UNIVERSAL

[A] WITH ELECTRONIC CONTROL
 AVEC CONTROLE ELECTRONIQUE
 MIT ELEKTRONISCHE STEUERUNG
 CON CONTROLLO ELETTRONICO
 CON CONTROL ELECTRONICO

[B] TRACTOR SIDE
 COTE TRACTEUR
 SCHLEPPER SEITE
 LATO TRATTORE
 LADO TRACTOR

[C] IMPLEMENT SIDE
 COTE OUTILS
 WERKZEUG SEITE
 LATO ATTREZZO
 LADO IMPLEMENTO

Hydraulic
Hydraulique
Hydraulik
Idraulica
Hidraulico

80-80

Load Sensing
Load Sensing
Load Sensing
Load Sensing
Load Sensing

5-BA55-032-A

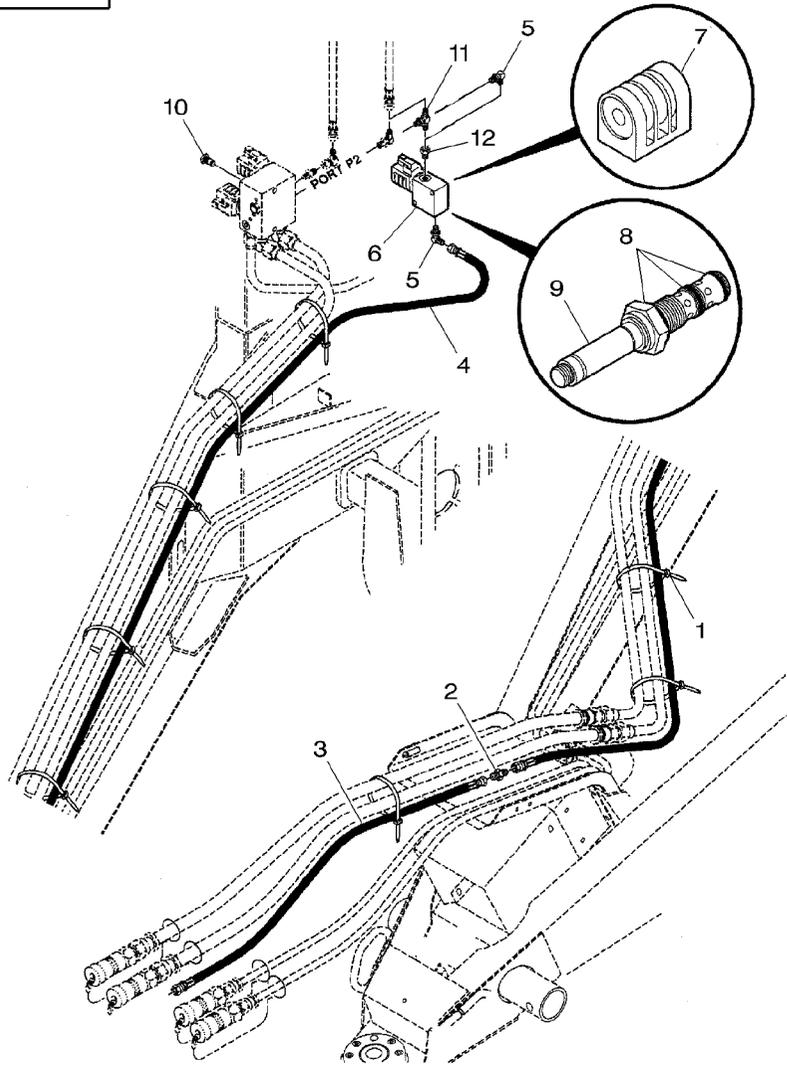

0 MK41152

1 70925442

2 846477

9/16"-18

3 700709957

4 700706300

5 70922523

6 700724342

7 700720644

6

8 700720679

6

9 700720916

6

10 700706602

11 70923894

12 700709216

1 KIT

8 CABLE TIE

1 UNION

1 HOSE

1 HYDRAULIC HOSE

2 ELBOW

1 PRESSURE VALVE

1 SOLENOID VALVE

1 KIT, SEAL

1 POPPET

1 PLUG

1 TEEPIECE

1 ADAPTOR

JEU
KIT

ATTACHE CABLE
FASCETTA CAVI

RACCORD
RACCORDO

DURITE
TUBO FLESSIBILE

DURITE HYDRAULIC
TUBO HYDRAULICO

COUDE
GOMITO

VALVE
VALVOLA PRESSION

VALVE SOLENOIDE
VALVOLA SOLENOIDE

JEU ETANCHEITE
KIT TENUTA

POUSSOIR VALVE
SUPPORTO VERTIC.

BOUCHON
TAPPO

TE
RACCORDO A T

ADAPTATEUR
ADATTATORE

SATZ
JUEGO

KABELBINDER
APRIETACABLES

VERSCHRAUBUNG
RACOR

SCHLAUCH
FLEXIBLE

HYDRAUL.SCHLAUCH
TUBO HYDRAULICO

WINKELSTUECK
CODO

DRUCKVENTIL
VALVOLA PRESSION

MAGNETVENTIL
VALVOLA SOLENOID

DICHTRINGSATZ
RETENES JUEGO

VENTILDRUCK
CONTRAPUNTA

VERSCHL.STOPFEN
TAPON

T-STUECK
PIEZA EN T

REDUZIERNIPPEL
ADAPTADOR

Lubrication
 Lubrification
 Schmieren
 Lubrificazione
 Engrase

80-85

Kit
 Kit
 Kit
 Kit
 Kit

5-BA16-047-A

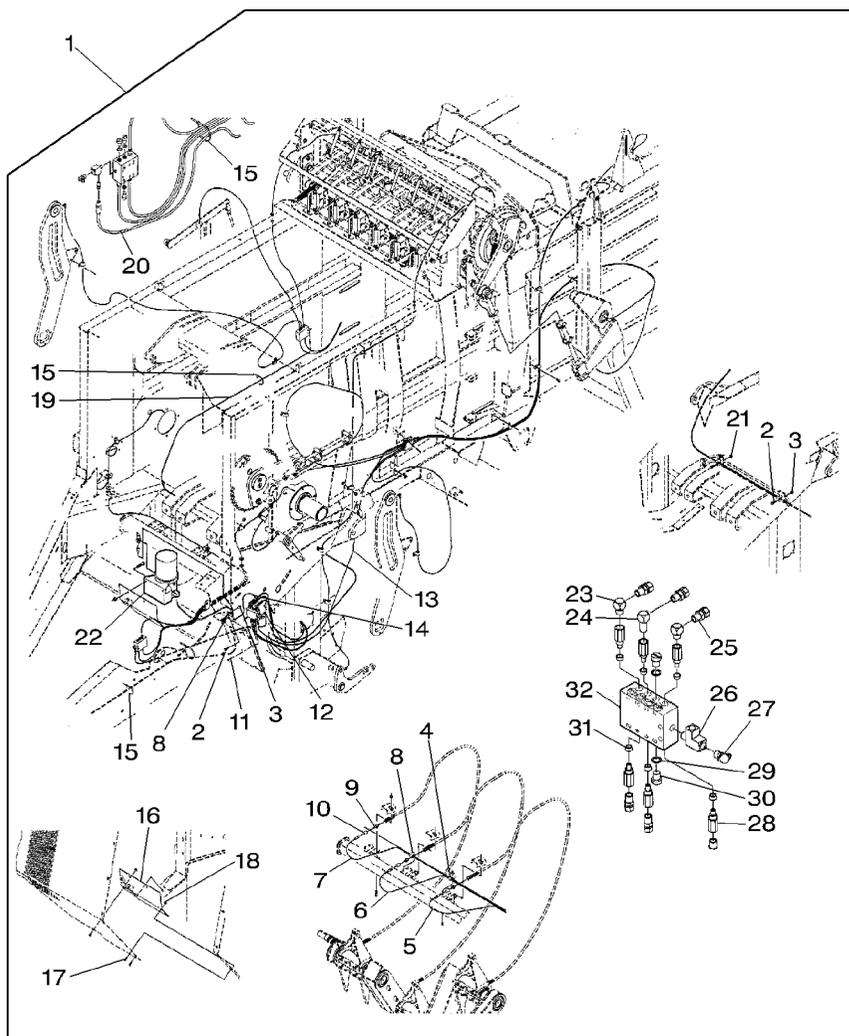

1	MK41020		1	KIT, ATTACHMENT	JEU ACCESSOIRES KIT ACCESSORI	SATZ ANBAUTEILE JUEGO ACCESORIO
2	7883382	1 3/8"-16 X 1	3	SCREW	VIS VITE	SCHRAUBE TORNILLO
3	Y704734	1 3/8"-16	3	LOCKNUT	ECROU BLOCAJE AUTOBLOCCANTE	SICHERUNGSMUTTER CONTRATUERCA
4	70926049	1 3/4"	1	CLAMP	COLLIER FASCETTA	HALTESCHELLE ABRAZADERA
5	700718128	1	1	HOSE	DURITE TUBO FLESSIBILE	SCHLAUCH FLEXIBLE
6	700720083	1	1	HOSE	DURITE TUBO FLESSIBILE	SCHLAUCH FLEXIBLE
7	700720082	1	1	HOSE	DURITE TUBO FLESSIBILE	SCHLAUCH FLEXIBLE
8	70925617	1 1/2"	2	CLAMP	COLLIER FASCETTA	HALTESCHELLE ABRAZADERA
9	70919171	1	3	UNION	RACCORD RACCORDO	VERSCHRAUBUNG RACOR
10	70901763	1	3	UNION	RACCORD RACCORDO	VERSCHRAUBUNG RACOR
11	7701444	1 No 10-32 X 1-3/4	2	SCREW	VIS VITE	SCHRAUBE TORNILLO
12	Y704445	1 No 10-32	2	NUT	ECROU DADO	MUTTER TUERCA
13	700718129	1	1	HOSE	DURITE TUBO FLESSIBILE	SCHLAUCH FLEXIBLE
14	700718126	1	1	HOSE	DURITE TUBO FLESSIBILE	SCHLAUCH FLEXIBLE
15	70925094	1	4	TIE	ATTACHE TRAVERSA ATTACCO	KUPPL.STANGE BARRA DE ENLACE
16	700150685P	1	1	SUPPORT	SUPPORT SUPPORTO	LAGERUNG DISPOS.DE SOSTEN
17	7883325	1 5/16"-18 X 3/4	1	SCREW	VIS VITE	SCHRAUBE TORNILLO
18	70931277	1 5/16"-18	1	NUT	ECROU DADO	MUTTER TUERCA
19	700726097	1	1	HOSE	DURITE TUBO FLESSIBILE	SCHLAUCH FLEXIBLE
20	700726096	1	1	HOSE	DURITE TUBO FLESSIBILE	SCHLAUCH FLEXIBLE
21	70928654	1	2	CLAMP	COLLIER FASCETTA	HALTESCHELLE ABRAZADERA
22	700720087	1 50-195 No 1	1	PUMP	POMPE POMPA	PUMPE BOMBA
23	700718963	1	2	ELBOW	COUDE GOMITO	WINKELSTUECK CODO
24	700718962	1	1	ELBOW	COUDE GOMITO	WINKELSTUECK CODO
25	700720091	1	9	CONNECTOR	BORNE MORSETTO	DOPPELNIPPEL CONECTOR
26	700720092	1	4	TEEPIECE	TE RACCORDO A T	T-STUECK PIEZA EN T

Lubrication
 Lubrification
 Schmierer
 Lubrificazione
 Engrase

80-85

Kit
 Kit
 Kit
 Kit
 Kit

5-BA16-047-A

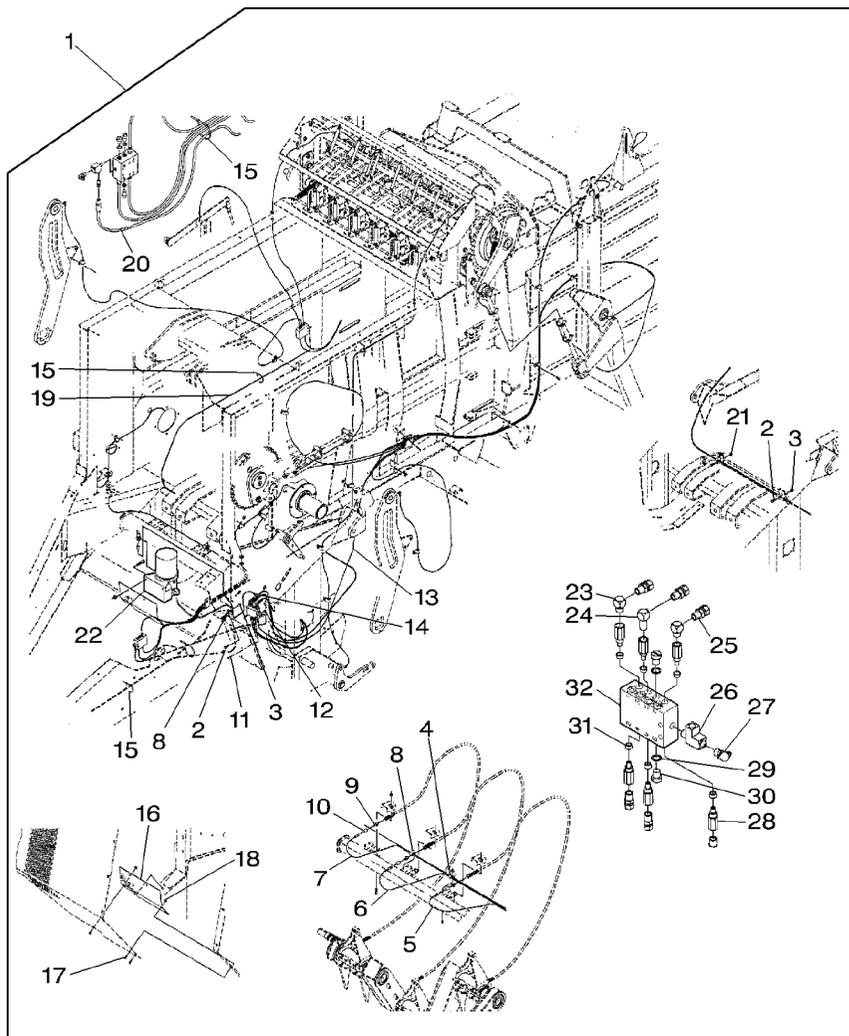

27	70915276	1	1 NIPPLE	GRAISSEUR COUDE NIPPLO	NIPPEL NIPLE
28	700720095	1	6 VALVE CHECK	VALVE CONTROLE VALVOLA RITEGNO	PRUEFVENTIL VALVULA D CIERRE
29	700706839	1	5 GASKET	JOINT GUARNIZIONE	DICHTSCHEIBE EMPAQUETADURA.
30	700706841	1	5 PLUG	BOUCHON TAPPO	VERSCHL.STOPFEN TAPON
31	700706678	1	6 FERRULE	VIROLE PUNTALE	ZWINGE MANGTO METALICO
32	700706837	1	1 VALVE.	SOUPAPE VALVOLA	VENTIL VALVULA

Lubrification
 Lubrification
 Schmieren
 Lubrificazione
 Engrase

80-90

Kit
 Kit
 Kit
 Kit
 Kit

5-BA16-062-A

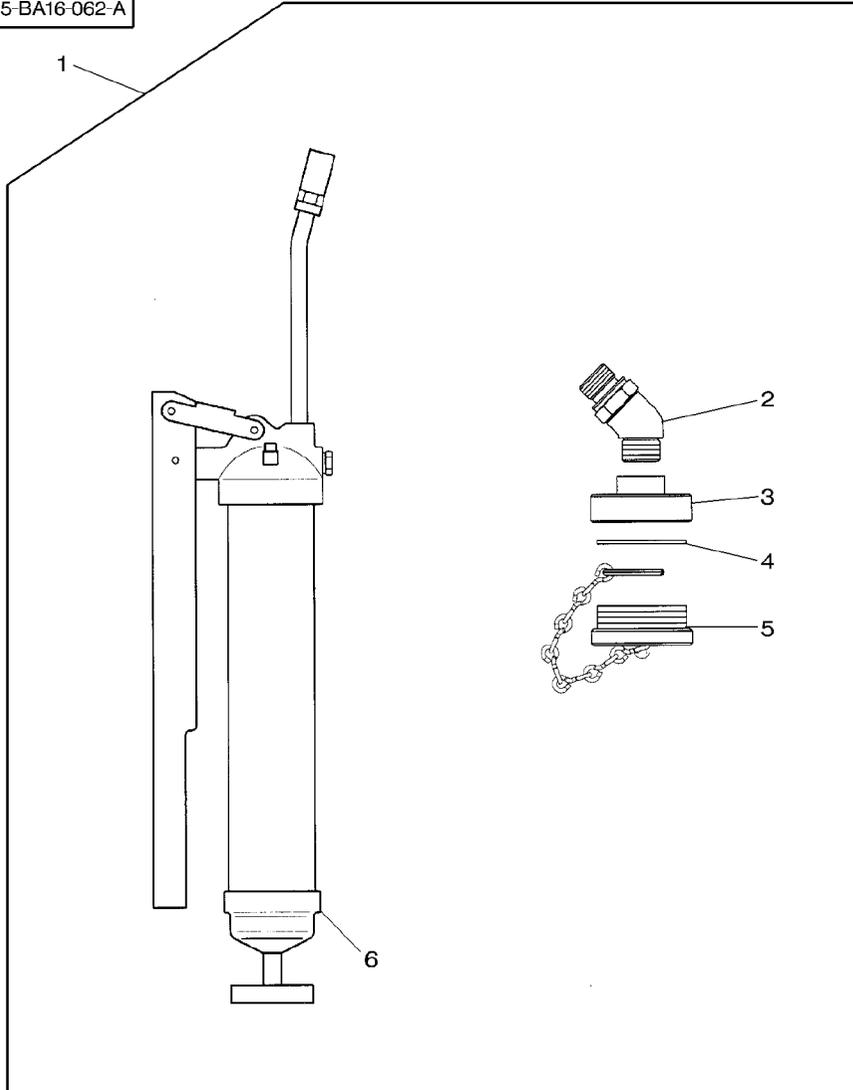

- 1 700726183
- 2 700726247
- 3 700726248
- 4 700726249
- 5 700726250
- 6 700726246

- 1
- 1
- 1
- 1
- 1
- 1

- 1 KIT
- 1 ELBOW
- 1 REDUCER
- 1 GASKET
- 1 CAP
- 1 GREASE GUN

JEU
 KIT
 COUDE
 GOMITO
 REDUCTEUR
 RIDUTTORE
 JOINT
 GUARNIZIONE
 CHAPEAU
 CAPUCHON
 POMPE A GRAISSE
 SIRINGA

SATZ
 JUEGO
 WINKELSTUECK
 CODO
 REDUZIERSTUECK
 PIEZA REDUCTORA
 DICHTSCHEIBE
 EMPAQUETADURA.
 KAPPE
 TAPA
 FETTPRESSE
 BOMBA DE ENGRASE

Fieldstar
Fieldstar
Fieldstar
Fieldstar
Fieldstar

80-95

Kit
Kit
Kit
Kit
Kit

5-XU38-003-A

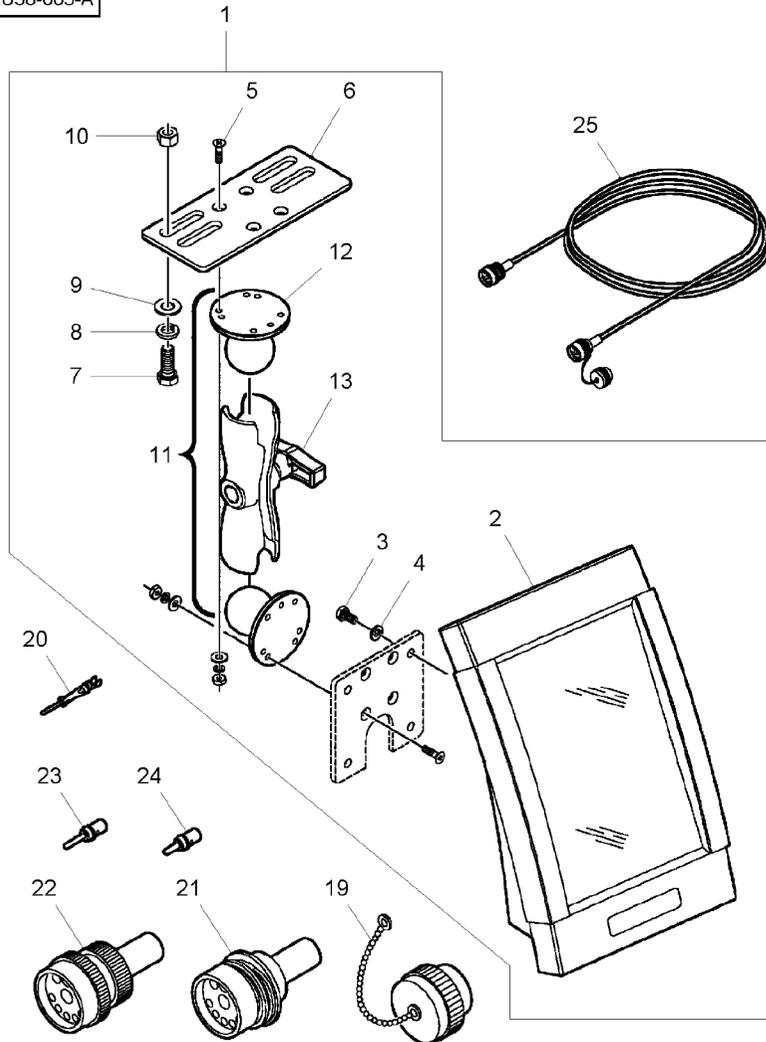

1	★MK41106		1	KIT, ATTACHMENT	JEU ACCESSOIRES	SATZ ANBAUTEILE
2	★D28989058	1	1	MONITOR	KIT ACCESSORI	JUEGO ACCESORIO
3	★7883978	1	1	M6 X 12	MONITOR	RATGEBER
4	★339375X1	1	1	M6	MONITORE	MONITOR
5	★373197X1	1	1	No 10-24 X 5/8	BOULON	MASCH.SCHRAUBE
5	★70917380	1	1	No 10	BULLONE	ESPIGA/BULON
5	★705004	1	1	No 10	RONDELLE FREIN	FEDERRING
5	★354120X1	1	1	No 10-24	ROSETTA DENTELL.	ARANDELA GROWER
6	★71408376	1	1		BOULON	MASCH.SCHRAUBE
7	★70921210	1	1	3/8"-16 X 1	BULLONE	ESPIGA/BULON
8	★70916965	1	1	3/8"	RONDELLE	UNTERLEGSCHIEBE
9	★70918266	1	1	3/8"	RONDELLE	ARANDELA
10	★70916950	1	1	3/8"-16	RONDELLE FREIN	FEDERRING
11	★71408378	1	1		ROSETTA DENTELL.	ARANDELA GROWER
12	★71408379	11	11		ECROU	MUTTER
13	★71408380	11	11		DADO	TUERCA
14	★72516644	1 [A]	1	SUPPORT	SUPPORTO	LAGERUNG
15	★72516645	1 [A]	1	CAPSCREW	SUPPORTO	DISPOS.DE SOSTEN
16	★700725961	1 [A]	1	LOCK WASHER	VIS BOUCHON	HUTSCHRAUBE
17	★700725818	1 [A]	1	LOCK WASHER	TAPPO A VITE	TORNILLO TAPON
18	★N858852	1 [A]	1	WASHER	RONDELLE FREIN	FEDERRING
19	★700716838	1 [A]	1		ROSETTA DENTELL.	ARANDELA GROWER
20	★N857481	(18 Gauge)	4	NUT	RONDELLE	UNTERLEGSCHIEBE
21	★71396309	(D)	4	KIT, MOUNTING	RONDELLA	ARANDELA
22	★N858734		1	BALL SUPPORT	ECROU	MUTTER
23	★700721775	(12 Gauge)	1	ARM	DADO	TUERCA
			1	MOUNTING	JEU MONTANT	MONTAGESATZ
			1	PART	KIT MONTAGGIO	JUEGO MONTAJE
			1	HARNESS	SUPPORT SPHER	KUGELHALTER
			1	MODULE	SUPPORTO SFERICO	SOPORTE DE ROTUL
			1	BASE	BRAS	ARM
			1	CAP	BRACCIO	BRAZO
			4	CONTACT	MONTANT	HALTERUNG
			1	CONNECTOR	SUPPORTO MONTAGG	MONTANTE
			1	CONNECTOR	PIECE	TEILE
			2	CONTACT	PEZZI	PIEZA
			1	CONNECTOR	FAISCEAU	KABELBAUM
			1	CONNECTOR	FASCIOCAVI	MAZO CABLES
			1	CONNECTOR	MODULE	MODUL
			1	CONNECTOR	MODULO	MODULO
			2	CONTACT	SEMELLE	FUSSPLATTE
			1	CONNECTOR	BASE	BASE
			1	CONNECTOR	CHAPEAU	KAPPE
			4	CONTACT	CAPUCHON	TAPA
			1	CONNECTOR	RUPTEUR	KONTAKT
			1	CONNECTOR	CONTATTO	CONTACTO
			1	CONNECTOR	BORNE	DOPPELNIPPEL
			1	CONNECTOR	MORSETTO	CONECTOR
			1	CONNECTOR	BORNE	DOPPELNIPPEL
			2	CONTACT	MORSETTO	CONECTOR
			2	CONTACT	RUPTEUR	KONTAKT
			2	CONTACT	CONTATTO	CONTACTO

Fieldstar
Fieldstar
Fieldstar
Fieldstar
Fieldstar

80-95

Kit
Kit
Kit
Kit
Kit

5-XU38-003-A

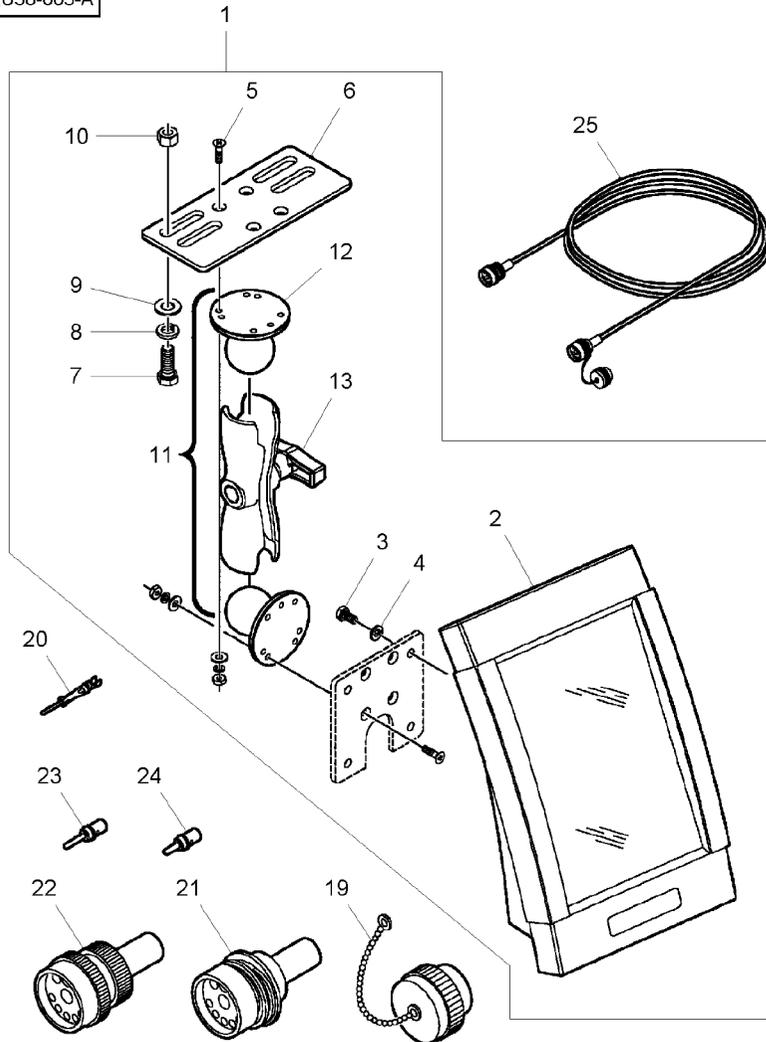

24 ★ 71399227 (8 Gauge)

25 ★ 700723738

2 CONTACT

1 HARNESS

RUPTEUR
CONTATTO
FAISCEAU
FASCIOCAVI

KONTAKT
CONTACTO
KABELBAUM
MAZO CABLES

[A] NOT ILLUSTRATED
NON ILLUSTRE
NICHT ABGEBILDET
NO ILLUSTRADO
NO ILLUSTRATED

5-BA20-004-A

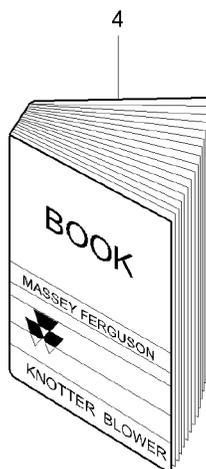
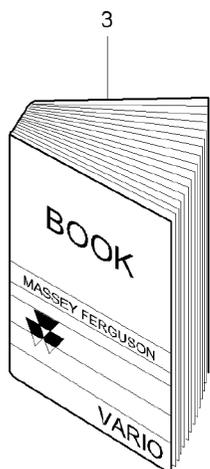
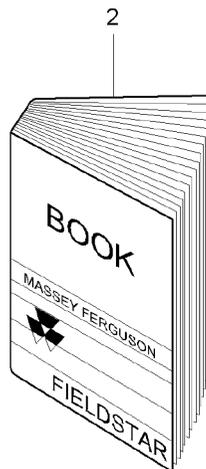
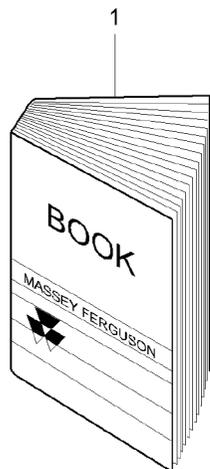

1 ✱700714440D	➡ 190LB-50100 (GB)	1 INSTRUCTION BOOK	GUIDEUTILISATION MANUALE ISTRUZI.	BETRIEBSANLEITG. MANUAL SERVICIO
1 ✱700715343	➡ 190LB-50101 ➡ 190LB-50146 (GB)	1 INSTRUCTION BOOK	GUIDEUTILISATION MANUALE ISTRUZI.	BETRIEBSANLEITG. MANUAL SERVICIO
1 ✱700716598E	➡ 190LB-50147 HK 91220 (GB)	1 INSTRUCTION BOOK	GUIDEUTILISATION MANUALE ISTRUZI.	BETRIEBSANLEITG. MANUAL SERVICIO
1 ✱700726592C	➡ HK 91221 (GB)	1 INSTRUCTION BOOK	GUIDEUTILISATION MANUALE ISTRUZI.	BETRIEBSANLEITG. MANUAL SERVICIO
1 ✱700722208C	[A] (GB)	1 INSTRUCTION BOOK	GUIDEUTILISATION MANUALE ISTRUZI.	BETRIEBSANLEITG. MANUAL SERVICIO
1 ✱700715345B	➡ 190LB-50101 ➡ 190LB-50146 (F)	1 INSTRUCTION BOOK	GUIDEUTILISATION MANUALE ISTRUZI.	BETRIEBSANLEITG. MANUAL SERVICIO
1 ✱700717433D	➡ 190LB-50147 HK 91220 (F)	1 INSTRUCTION BOOK	GUIDEUTILISATION MANUALE ISTRUZI.	BETRIEBSANLEITG. MANUAL SERVICIO
1 ✱700723078A	[A] (F)	1 INSTRUCTION BOOK	GUIDEUTILISATION MANUALE ISTRUZI.	BETRIEBSANLEITG. MANUAL SERVICIO
1 ✱700715347B	➡ 190LB-50101 ➡ 190LB-50146 (D)	1 INSTRUCTION BOOK	GUIDEUTILISATION MANUALE ISTRUZI.	BETRIEBSANLEITG. MANUAL SERVICIO
1 ✱700717444D	➡ 190LB-50147 HK 91220 (D)	1 INSTRUCTION BOOK	GUIDEUTILISATION MANUALE ISTRUZI.	BETRIEBSANLEITG. MANUAL SERVICIO
1 ✱700723081A	[A] (D)	1 INSTRUCTION BOOK	GUIDEUTILISATION MANUALE ISTRUZI.	BETRIEBSANLEITG. MANUAL SERVICIO
1 ✱700715349A	➡ 190LB-50101 ➡ 190LB-50146 (E)	1 INSTRUCTION BOOK	GUIDEUTILISATION MANUALE ISTRUZI.	BETRIEBSANLEITG. MANUAL SERVICIO
1 ✱700717457D	➡ 190LB-50147 HK 91220 (E)	1 INSTRUCTION BOOK	GUIDEUTILISATION MANUALE ISTRUZI.	BETRIEBSANLEITG. MANUAL SERVICIO
1 ✱700723079A	[A] (E)	1 INSTRUCTION BOOK	GUIDEUTILISATION MANUALE ISTRUZI.	BETRIEBSANLEITG. MANUAL SERVICIO
1 ✱700715549C	➡ 190LB-50101 ➡ 190LB-50146 (DK)	1 INSTRUCTION BOOK	GUIDEUTILISATION MANUALE ISTRUZI.	BETRIEBSANLEITG. MANUAL SERVICIO
1 ✱700717250D	➡ 190LB-50147 HK 91220 (DK)	1 INSTRUCTION BOOK	GUIDEUTILISATION MANUALE ISTRUZI.	BETRIEBSANLEITG. MANUAL SERVICIO
1 ✱700723082A	[A] (DK)	1 INSTRUCTION BOOK	GUIDEUTILISATION MANUALE ISTRUZI.	BETRIEBSANLEITG. MANUAL SERVICIO
1 ✱700723083A	[A] (I)	1 INSTRUCTION BOOK	GUIDEUTILISATION MANUALE ISTRUZI.	BETRIEBSANLEITG. MANUAL SERVICIO
2 ✱700720579C	(GB)	1 INSTRUCTION BOOK	GUIDEUTILISATION MANUALE ISTRUZI.	BETRIEBSANLEITG. MANUAL SERVICIO
2 ✱700722534B	(F)	1 INSTRUCTION BOOK	GUIDEUTILISATION MANUALE ISTRUZI.	BETRIEBSANLEITG. MANUAL SERVICIO

5-BA20-004-A

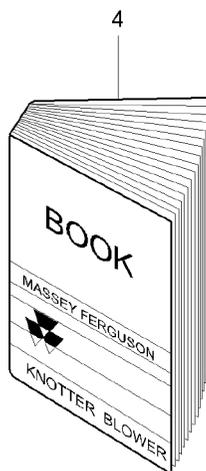
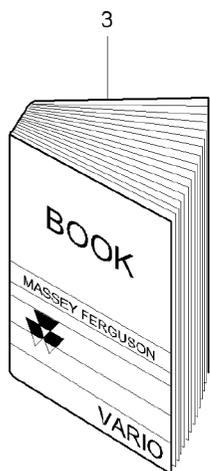
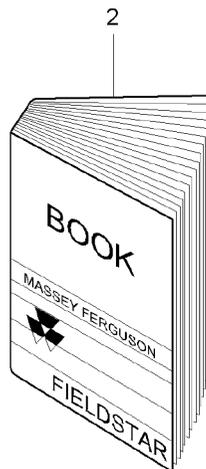
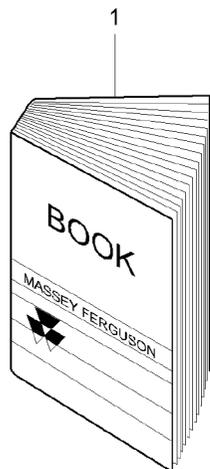

- 2★700721913B (D)
- 2★700722535B (E)
- 2★700722533B (DK)
- 2★700722532B (I)
- 3★700722402A (GB)
- 3★700722691A (D)
- 4★700719423C

- | | | |
|--------------------|--------------------------------------|-------------------------------------|
| 1 INSTRUCTION BOOK | GUIDEUTILISATION
MANUALE ISTRUZI. | BETRIEBSANLEITG.
MANUAL SERVICIO |
| 1 INSTRUCTION BOOK | GUIDEUTILISATION
MANUALE ISTRUZI. | BETRIEBSANLEITG.
MANUAL SERVICIO |
| 1 INSTRUCTION BOOK | GUIDEUTILISATION
MANUALE ISTRUZI. | BETRIEBSANLEITG.
MANUAL SERVICIO |
| 1 INSTRUCTION BOOK | GUIDEUTILISATION
MANUALE ISTRUZI. | BETRIEBSANLEITG.
MANUAL SERVICIO |
| 1 INSTRUCTION BOOK | GUIDEUTILISATION
MANUALE ISTRUZI. | BETRIEBSANLEITG.
MANUAL SERVICIO |
| 1 INSTRUCTION BOOK | GUIDEUTILISATION
MANUALE ISTRUZI. | BETRIEBSANLEITG.
MANUAL SERVICIO |

[A] WITH ELECTRONIC CONTROL
AVEC CONTROLE ELECTRONIQUE
MIT ELEKTRONISCHE STEUERUNG
CON CONTROLLO ELETTRONICO
CON CONTROL ELECTRONICO